

January 2015

# JOURNAL OF INTELLECTUAL PROPERTY LAW

Collected Writings of Banner & Witcoff in 2014



BANNER & WITCOFF, LTD.  
INTELLECTUAL PROPERTY LAW

# Journal of Intellectual Property Law

## January 2015

Collected Writings of  
Banner & Witcoff, Ltd. in 2014

Chicago  
312.463.5000

Washington  
202.824.3000

Boston  
617.720.9600

Portland  
503.425.6800

[www.bannerwitcoff.com](http://www.bannerwitcoff.com)

**Copyright 2015 Banner & Witcoff, Ltd., subject to any previously granted rights. Further duplication is not permitted without permission. All rights reserved. These materials are designed to provide thought-provoking ideas and information on the subjects covered. These materials are not legal advice and should not be used as such. The ideas and information provided may not necessarily reflect the opinions of Banner & Witcoff, Ltd. or its lawyers, may not reflect current legal developments, and are not guaranteed to be correct, accurate, complete or up-to-date. Viewing or use of these materials does not create an attorney-client relationship between you and any lawyer of Banner & Witcoff, Ltd., and you should not act upon the information contained without legal advice. You are welcome to contact any author for further information or advice on the subject of his or her writings.**



*What inspires me?  
A fresh perspective.*



## Intellectual Property Law: Counseling, Licensing, Litigation & Procurement.

A national law firm with more than 90 attorneys and 90 years of practice, Banner & Witcoff provides legal counsel and representation to the world's most innovative companies. Our attorneys are known for having the breadth of experience and insight needed to handle complex patent applications as well as handle and resolve difficult disputes and business challenges for clients across all industries and geographic boundaries.

**LITIGATION**—The firm is a preferred litigation provider for Fortune 500 companies, midlevel companies, and technology-focused start-ups. The key to the firm's successful litigation practice is our ability to match an exceptional trial capability with a common sense approach to litigation, and we are committed to understanding how our clients will measure success because each matter is different. We take pride in tailoring litigation strategies to fit our clients' interests and goals, taking into account the legal framework, facts, and business realities of each case in a broad variety of substantive and technological areas. Our attorneys try cases before judges and juries in both federal and state courts around the country, at the appellate levels, and before the ITC and the USPTO. The firm has successfully represented clients in landmark cases, including several renowned intellectual property decisions including *Tasini v. The New York Times*, *Deepsouth Packing Co. v. Laitram Corp.*, and *Diamond v. Chakrabarty*.

**TRADEMARKS**—With our clients, our attorneys evaluate trademark use and registrability issues. We obtain trademark registrations efficiently and effectively for domestic and international clients. We devise overarching brand- and product-oriented trademark strategies, both offensive and defensive for our clients as well as licensing and assigning trademarks to and from our clients. We manage and maintain large and complex trademark portfolios for global corporations, and we enforce and defend against trademark infringement allegations both domestically and internationally, including through oppositions, cancellations, court litigation, and Customs procedures.

At Banner & Witcoff we believe that people with diverse experiences produce creative thinking, multiple perspectives on issues, and innovative problem-solving techniques in the practice of intellectual property law. That is why we are committed to creating and fostering a firm culture that values the differences among its attorneys, legal professionals, and support staff. As part of our commitment to diversity, Banner & Witcoff proudly offers the Donald W. Banner Diversity Scholarship for law students. Visit [www.bannerwitcoff.com/diversity](http://www.bannerwitcoff.com/diversity) for more information.

**PATENTS**—Preparation and prosecution of patent applications, both in the U.S. and abroad, was the historical basis for the firm's practice at its founding in the 1920's, and has been significant in our client services ever since. Prosecution, licensing, counseling and opinion remain as important core services of the firm. We work with our clients to develop, manage and protect their strategic portfolios from the initial assessment through enforcement. Our experience includes all patent practice areas of law including: patent application filing and prosecution; appeals; interferences; and, reexaminations and reissue.

**COPYRIGHTS**—Our attorneys enforce rights through negotiation, arbitration and litigation. We establish programs for large quantities of copyright registrations, draft license agreements for authors and publishers, and provide counseling and opinions regarding everything from copyright of software to recipes and from architecture to literary works. The firm has also successfully implemented nationwide enforcement programs to stop importation of "knock-offs" of copyrighted goods. We have provided clearance opinions to website operators for copyrighted material including literary and artistic works; investigated and provided opinions regarding metatag infringement; and negotiated copyright licenses for on-line electronic media.

### INDUSTRY EXPERIENCE

- Aerospace
- Athletic Equipment & Apparel
- Automotive & Transport
- Chemicals
- Computer Hardware & Software
- E-Commerce
- Electronics
- Energy
- Food & Beverages
- Financial Services
- Gaming
- Health Care
- Higher Education
- Industrial Manufacturing & Design
- Insurance
- Life Sciences
- Medical Devices & Methods
- Metals & Mining
- Telecommunications

**COPYRIGHTS**

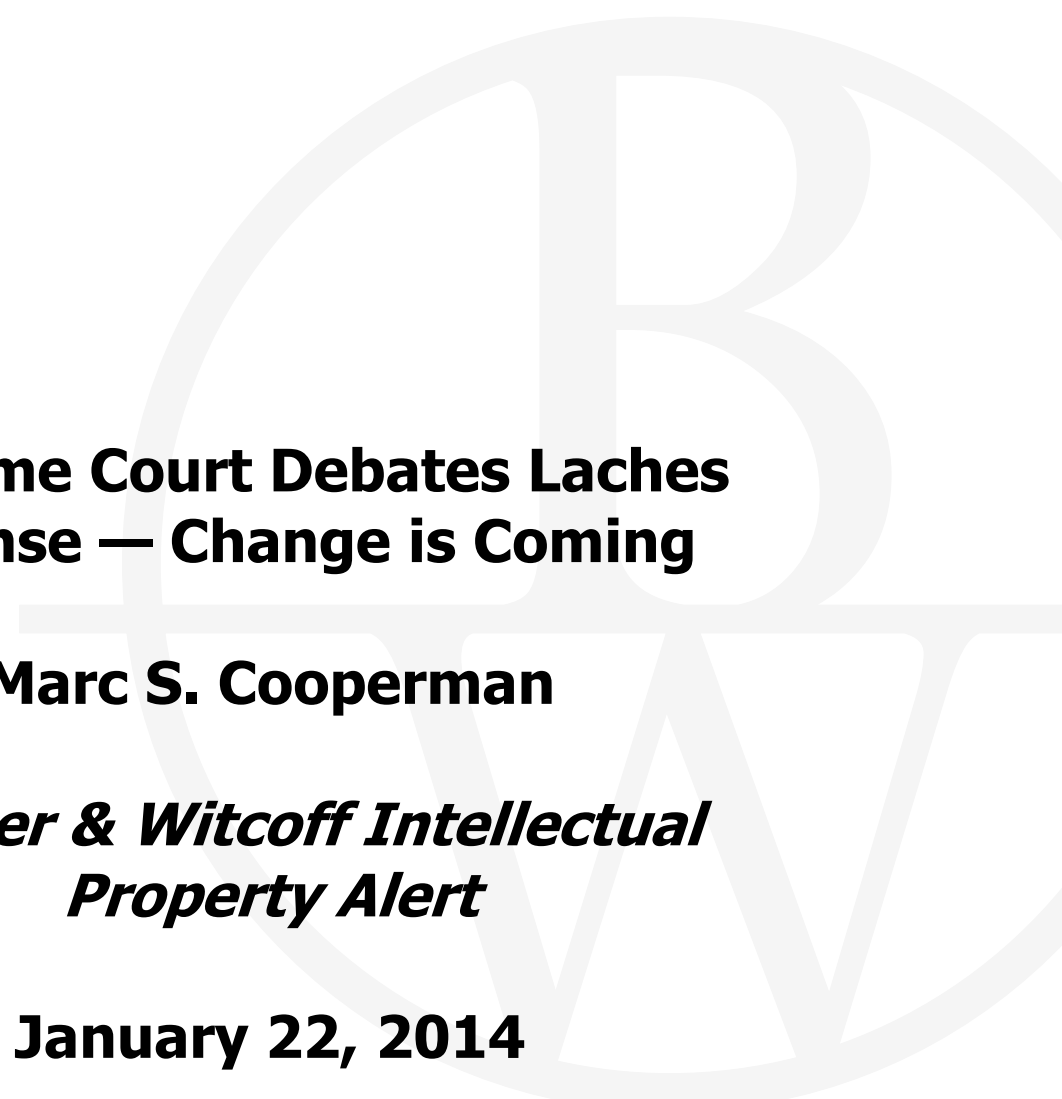

**Supreme Court Debates Laches  
Defense — Change is Coming**

**Marc S. Cooperman**

***Banner & Witcoff Intellectual  
Property Alert***

**January 22, 2014**



## Intellectual Property Alert: Supreme Court Debates Laches Defense — Change Is Coming

By **Marc S. Cooperman**

Jan. 22, 2014 — In an energetic oral argument on Jan. 21 that would have made first-year law students cringe, the Supreme Court debated the proper role of laches as a defense against the backdrops of statutory language versus Congressional intent, equitable versus legal remedies, and the Rules Enabling Act (for those of you who may not remember that, it's the 1934 Act leading to the creation of the Federal Rules of Civil Procedure). Specifically, in *Petrella v. Metro-Goldwyn-Mayer, Inc.*, the Justices will decide what role, if any, the venerable equitable defense of laches plays under the Copyright Statute, where Congress has provided for an express three-year statute of limitations. Notably, based on the Court's questions, it is plausible that the decision will impact patent and trademark litigation as well, where laches is also frequently raised as a defense.

### **“Raging Bull”**

The case involves a claim of copyright infringement concerning the movie and screenplay for the boxing biography “Raging Bull.” Petrella — the daughter of one of the authors — sued MGM claiming both damages and an injunction for violation of her father's copyrights. MGM won summary judgment that laches barred the suit because Petrella had delayed too long (allegedly 19 years) in filing suit. On appeal the Ninth Circuit affirmed, rejecting Petrella's argument that laches could not bar relief for infringing acts occurring within the three-year statute of limitations time period before suit was filed. The Supreme Court granted certiorari due to the split among the circuits as to the availability of laches as a defense in copyright cases, and what impact the defense has if it is available.

### **Supreme Court Argument**

Every Justice except Thomas expressed views during the oral argument, in which the government also participated. Predictably, Justice Scalia was most active, interrupting Petrella's counsel immediately after he started. Scalia traded barbs with both sides, at one point suggesting to MGM's counsel that the Courts may not have the authority to even consider certain equitable defenses such as laches. Much of the debate focused on the “background” cases against which Congress legislated when it added the limitations statute, in an effort to discern the legislative intent. Several of the Justices agreed that laches — which addresses prejudice to one party caused by the unreasonable delay of the other party — serves a different purpose than a statute of limitations, and suggested that both can coexist. There was significant discussion, however, on the impact of a laches defense on the remedies available.

## **A Pox on the Federal Circuit?**

Siding completely with neither party, the government advocated that laches should be available in “exceptional cases” as a defense within the three-year statutory period, but only as a bar to equitable relief, not damages. Justice Ginsburg pointed out that this does not align with the Federal Circuit’s precedent in patent cases, which holds just the opposite: that laches bars pre-suit damages but not equitable relief. The government’s counsel recognized this distinction and argued it was justified based on the differing statutory contexts. MGM’s counsel went further, arguing that the Federal Circuit “can’t be right” about preventing laches from impacting injunctive relief, as that was based on pre-*eBay* case law and reflects the Federal Circuit’s “predilection” for “categorical rules.”

## **Conclusion**

It seems unlikely that the Supreme Court will adopt Petrella’s argument that laches is not available as a defense in copyright cases. What will likely come from the decision is guidance from the Justices concerning the proper role of laches when it is proven — specifically whether it may be considered when considering damages, injunctive relief, or both. This could have far reaching consequences into trademark and patent litigation, just as the Supreme Court’s copyright decision in *Grokster* provided guidance to the Federal Circuit in reshaping its induced infringement jurisprudence. The Court’s decision is expected by June.

To subscribe or unsubscribe to this Intellectual Property Advisory, please send a message to Chris Hummel at [chummel@bannerwitcoff.com](mailto:chummel@bannerwitcoff.com)



[www.bannerwitcoff.com](http://www.bannerwitcoff.com)

© Copyright 2014 Banner & Witcoff, Ltd. All Rights Reserved. The opinions expressed in this publication are for the purpose of fostering productive discussions of legal issues and do not constitute the rendering of legal counseling or other professional services. No attorney-client relationship is created, nor is there any offer to provide legal services, by the publication and distribution of this edition of IP Alert.





**The Google Books Case — Here's the  
Skinny**

**Steve S. Chang**

***Banner & Witcoff Intellectual  
Property Update***

**April 21, 2014**

Regarding the purpose and character of use, the court noted that Google's use was highly transformative, in that Google's scans of the books created an important tool for research that does not supplant the books.

## THE GOOGLE BOOKS CASE – HERE'S THE SKINNY



BY: STEVE CHANG

I'm sure many of us have fond memories of the venerable library card catalog: the musty smell, the tiny wooden drawers and their endless deck of equally tiny, yellowed cards on which someone laboriously typed the Dewey Decimal code, bibliographic information and a short, textual summary of a book. But ever since the opening scene in the 1984 classic "Ghostbusters," library researchers have tirelessly sought to develop a way to catalog books in a way that isn't susceptible to ruination by the drawer-emptying, card-throwing tendencies of a ghost librarian<sup>1</sup>.

In 2004, Google Inc. announced its solution. Google had entered into agreements with several major research libraries to scan the full text of millions of books in those libraries, to catalog the books electronically and allow users to run full-text keyword searches through those millions of books. However, the announcement troubled several authors and owners of copyright — should Google be permitted to make copies of their works, without permission? In 2005, The Authors Guild, Inc. and several individual authors filed suit against Google to challenge Google's plan. In late 2013, the U.S. District Court for the Southern District of New York ruled in Google's favor on summary judgment<sup>2</sup> and held that Google's actions were fair use. This article provides a summary of the issues involved, the reasoning behind the decision and the takeaways from the case.

<sup>1</sup> If you happened to miss this classic hit, it opens with a scene in which a ghost librarian slimes and scatters the contents of a library's card catalog, and ends with making you either want, or hate, marshmallows.

<sup>2</sup> *Authors Guild, Inc. v. Google, Inc.*, 954 F.Supp.2d 282 (S.D.N.Y. 2013).

### IN A NUTSHELL, WHAT'S THE DISPUTE?

The parties do not dispute that Google is making copies of the books. The issue in dispute is whether that copying is protected under the Fair Use Doctrine.

### WHAT'S FAIR USE, REALLY?

Fair use basically means there are certain situations in which copying is excused under the Copyright Laws. The Fair Use Doctrine is codified in 17 U.S.C. § 107 (the Copyright Act), and specifically states that "the fair use of a copyrighted work ... for purposes such as criticism, comment, news reporting, teaching (including multiple copies for classroom use), scholarship, or research, is not an infringement of copyright." The Act goes on to list four key factors that a court should consider when evaluating a claim of fair use:

"In determining whether the use made of a work in any particular case is a fair use the factors to be considered shall include:

- 1) the purpose and character of the use, including whether such use is of a commercial nature or is for nonprofit educational purposes;
- 2) the nature of the copyrighted work;
- 3) the amount and substantiality of the portion used in relation to the copyrighted work as a whole; and
- 4) the effect of the use upon the potential market for or value of the copyrighted work."

Classic examples of situations where the Fair Use Doctrine has applied include: news reporters copying portions of a work for purposes of news reporting and criticism;<sup>3</sup> users of VCRs recording television programs for later viewing;<sup>4</sup> artists copying work, but transforming it to make new works,<sup>5</sup> and in parody situations.<sup>6</sup>

## WHAT DID THE COURT DECIDE, AND WHY?

On summary judgment, Judge Denny Chin considered a variety of factors, and ultimately concluded that Google's actions were fair use. The court considered the four factors enumerated above, but even before doing so, the court pointed out several aspects that tilted in Google's favor.

First, the court noted that Google took quite a few measures to ensure that users<sup>7</sup> could not simply obtain a free copy of books by searching for them. Search results only showed users a "snippet" view of the search result in context. To counter users who may try to gather an entire book a snippet at a time, Google's search intentionally excluded 10 percent of the pages of a book from the snippet view, and intentionally excluded one snippet on each page so that the particular snippet would not be shown. Furthermore, works that had smaller chunks, such as dictionaries, cookbooks and books of haiku, were excluded from snippet view altogether.

Second, the court noted how beneficial Google Books is to scholarly research. The court pointed out that Google Books helps librarians find sources, facilitates interlibrary lending and is used in at least one education curriculum. The court also noted that Google's index allowed a new type of research — "data mining" — in which searchers could examine things like word frequencies and historical changes in grammar usage patterns in ways that simply were not feasible before the Google Books project.

The court also found that Google Books expands access to books (e.g., text-to-speech conversion allows access to the blind), helps preserve books (e.g., many of the scanned books were out-of-print texts that would be difficult to find otherwise), and also helps authors and publishers because the search results take users to links where the books can be purchased.

After extolling those virtues, the court went on to specifically address the four factors. Regarding the purpose and character of use, the court noted that Google's use was highly transformative, in that Google's scans of the books created an important tool for research that does not supplant the books. The court acknowledged that Google is a for-profit enterprise, but noted that Google doesn't sell the scans, does not run advertisements on the pages with the snippets and does not directly benefit from any commercialization of the books that it scanned. Google makes money indirectly since Google Books users, while on the site, may well use other Google tools with advertising revenue, but the court cited several prior cases in which fair use was found despite some commercial benefit being bestowed on the defendant. The court found that the first factor strongly favored a finding of fair use.

Regarding the nature of the work, the court noted that all of the books were published and available to the public and that the majority of the books (93 percent) were non-fiction (works of non-fiction generally receive lesser copyright protection since facts themselves are not copyrightable). The court found that the second factor favored a finding of fair use.

Regarding the amount and substantiality of the portion used, the court acknowledged that Google's copying was verbatim and complete, but emphasized that Google limited the amount of text displayed in response to a search and noted that the complete copying was needed to provide the Google Books functionality. On the balance, the court found that the third factor slightly weighed against a finding of fair use.

<sup>3</sup> See, e.g., *Religious Technology Center v. Pagliarini*, 908 F.Supp. 1353 (E.D. Va. 1995) (*the Washington Post* newspaper quoted brief portions of Church of Scientology texts in an article, and its use was deemed a fair use); and *Italian Book Corp. v. American Broadcasting Co.*, 458 F.Supp. 65 (S.D.N.Y. 1978) (a television film crew covering a festival recorded a band playing a portion of a copyrighted song, and the film was replayed during the news broadcast — the unauthorized reproduction of the song portion in this case was deemed fair use).

<sup>4</sup> See *Sony Corp. v. Universal City Studios.*, 464 U.S. 417 (1984) (home videotaping was deemed fair use).

<sup>5</sup> See, e.g., *Campbell v. Acuff-Rose Music*, 510 U.S. 569 (1994) (rap group 2 Live Crew sampled portions of the song "Pretty Woman," but transformed the small part copied to create a new work that was deemed fair use).

<sup>6</sup> See, e.g., *Leibovitz v. Paramount Pictures Corp.*, 137 F.3d 109 (2d Cir. 1998) (a movie company superimposed head of actor Leslie Nielsen on a photo of a naked pregnant woman, parodying a famous magazine cover photograph).

<sup>7</sup> The participating libraries were entitled to receive full digital copies of the books that the libraries provided to Google, but others only got a "snippet" view.

**MORE>**

[GOOGLE BOOKS, FROM PAGE 5]

As for the effect of the use on the potential market or value, the court disagreed with the plaintiffs, finding that it would be unlikely for anyone to try and piece together a full copy of a book one snippet at a time (and in view of the fact that some snippets and pages would simply never be found by such a user). The court found that a reasonable fact-finder could only find that Google Books enhances the sales of books, since the tool publicizes the books and provides convenient links to retailers selling the books. The court found that the fourth factor strongly weighed in favor of a finding of fair use.

Given the weighing above, the court concluded that Google Books is a fair use of the copyrighted books that it scanned.

#### WHAT'S NEXT?

The Authors Guild Inc. and the individual authors appealed the decision at the end of 2013, and the appeal is working its way through the Court of Appeals for the Second Circuit.

#### WHAT DID I MISS (TAKEAWAYS)?

Here are the big picture takeaways from the case thus far:

- Google Books' full-text scanning of millions of books to provide full-text search capability was deemed a fair use.
- Google Books helped its cause by 1) taking steps to prevent users from getting a free copy of the book through its searches, 2) avoiding direct profits from the use of the copied works, 3) providing links to help users purchase the books that were found in the search, and 4) providing a tool that offers many benefits to the research community.
- The case is currently under appeal at the Court of Appeals for the Second Circuit.
- There's a ghost librarian in the movie "Ghostbusters." ■

## SAVE THE DATE!

### BANNER & WITCOFF'S CORPORATE INTELLECTUAL PROPERTY SEMINAR

Please save **Friday, Sept. 19, 2014**, for Banner & Witcoff's Corporate IP Seminar at the University of Chicago Gleacher Center. We will host morning and afternoon sessions with topics selected to help you protect your corporation's IP assets.

If there are topics or questions you would like addressed during the seminar, please send them to us at [event@bannerwitcoff.com](mailto:event@bannerwitcoff.com). We look forward to seeing you in the fall!

**FRIDAY, SEPT. 19, 2014**  
**8:30 A.M.-4:30 P.M.**  
**UNIVERSITY OF CHICAGO GLEACHER CENTER**  
**450 N. CITYFRONT PLAZA DRIVE**  
**CHICAGO, IL**

For more information, please contact Chris Hummel at 202.824.3126 or [chummel@bannerwitcoff.com](mailto:chummel@bannerwitcoff.com)



**U.S. Supreme Court Hears Oral  
Arguments in *ABC v. Aereo***

**Rajit Kapur**

***Banner & Witcoff Intellectual  
Property Alert***

**April 23, 2014**



## Intellectual Property Alert: U.S. Supreme Court Hears Oral Arguments in *ABC v. Aereo*

By **Rajit Kapur**

April 23, 2014 – Yesterday, the U.S. Supreme Court heard oral arguments in *American Broadcasting Companies, et al. v. Aereo*. The case presents issues of copyright law in the context of streaming video content over the Internet, but the ruling could have a broader impact on cloud computing technologies.

### **Case Background**

In Boston, New York and other select cities where Aereo has launched its service, Aereo enables its customers to receive and view broadcast television content on their computers or mobile devices via the Internet. Aereo charges its users a relatively small monthly fee for access to its service (\$8 or \$12 per month depending on the city), but unlike cable and satellite providers, does not pay a retransmission fee or provide any other compensation to the broadcasters whose signals Aereo captures to provide its service.

Notably, Aereo presents itself as an equipment rental company that merely provides an antenna and a digital video recorder (DVR) to each of its users — something that its users could purchase and legally use in their own home to view and record broadcast television — except that Aereo provides its users with access to their antenna and DVR over the Internet.

In addition, Aereo has designed its signal reception systems to include arrays of tiny antennas, each of which is about the size of a dime and can be dynamically assigned to an individual user when a user requests to view a particular broadcast channel. The video signal received by each antenna is individually recorded for only the one specific user to which the antenna has been assigned, allowing Aereo to further analogize its system to the rabbit ears antenna and personal DVR that each of its users could legally use in their own home to view and record broadcast television.

In March 2012, several broadcasters, including ABC, CBS, NBC Universal and Fox, sued Aereo, alleging copyright infringement. In particular, at issue in this case is the copyright laws' protection of the right of public performance of a copyrighted work. The broadcasters argue that Aereo infringes this right because its retransmission of their video broadcasts to Aereo users constitutes an unauthorized public performance of the copyrighted video broadcasts. In its defense, Aereo essentially argues that it is merely renting equipment to its users — in the form of an individual antenna, receiver and DVR — and simply providing access to this equipment via the cloud.

## **The Oral Arguments**

Aereo’s defense is grounded in its clever system design, which is seemingly tailored to avoid the provisions of the copyright laws — something that was not lost on the Supreme Court. Indeed, early on, Justice Ginsburg asked Aereo’s counsel if there was a “technically sound reason” for using multiple antennas or if “the only reason for that was to avoid the breach of the Copyright Act.”<sup>1</sup>

At several other points during the oral argument, Chief Justice Roberts pressed Aereo’s counsel on whether there is any technological basis for its system design. For example, in a line that garnered laughter from the audience in the courtroom, Chief Justice Roberts told Aereo’s counsel that “I’m just saying your technological model is based solely on circumventing legal prohibitions that you don’t want to comply with, which is fine. I mean that’s — you know, lawyers do that.”<sup>2</sup>

Humor aside, however, the Justices seemed very concerned from the outset about how a ruling against Aereo could impact the cloud computing industry more generally. Justice Sotomayor peppered the broadcasters’ counsel very early on about this point, and her concerns seemed shared by several other Justices, including Justice Breyer and Justice Kagan.

Of particular concern to the Court was how its definition of “public performance” in this case could have a broader impact on cloud computing technologies. The right to publicly perform a copyrighted work is one of the rights protected under copyright law, and transmitting a copyrighted work to multiple recipients (e.g., via a broadcast television signal or radio signal) has traditionally been understood to implicate this right.

If, in this case, the Court were to rule that Aereo’s transmission of a user-specific video recording to an individual user constituted a “public performance” of a copyrighted work, such a ruling might result in other types of user-specific transmissions of copyrighted works from cloud service providers to end users also being considered “public performances.” Justice Sotomayor specifically identified Dropbox and iCloud as examples of the types of services that she was concerned about impacting.<sup>3</sup>

Rather than ultimately ruling on whether Aereo is “publicly performing” a copyrighted work in providing its users with access to broadcast video content, however, the Court may be able to find another creative way to dispose of this case without affecting cloud computing technologies. For example, Justice Breyer raised the notion of the “first sale doctrine” during the oral arguments,<sup>4</sup> which could allow the Court to draw a line between content that an end user has purchased and other types of content. Alternatively, the Court could remand the case — something else that Justice Breyer hinted at<sup>5</sup> — perhaps to explore the question of whether Aereo

---

<sup>1</sup> Transcript of Oral Argument at page 30, lines 4-7.

<sup>2</sup> Transcript of Oral Argument at page 41, lines 20-25.

<sup>3</sup> Transcript of Oral Argument at page 8, lines 6-16.

<sup>4</sup> Transcript of Oral Argument at page 6, lines 7-18.

<sup>5</sup> Transcript of Oral Argument at page 6, line 24, to page 7, line 7.

should be treated as a cable company that must play by the same rules that other cable and satellite providers are subject to.

Overall, the questioning of the broadcasters' counsel during the oral arguments seemed to reveal a great deal of concern that a ruling against Aereo might have a broader impact on cloud computing technology, while the questioning of Aereo's counsel seemed to reveal at least some skepticism that Aereo's service as it stands complies with the copyright laws. Nevertheless, it is difficult to predict how the Court will ultimately rule in this case, given the issues that the Justices seemed to struggle with on both sides of the argument.

We will continue to monitor this interesting case, which is *American Broadcasting Companies, et al. v. Aereo*, No. 13-461.

To subscribe or unsubscribe to this Intellectual Property Advisory,  
please send a message to Chris Hummel at [chummel@bannerwitcoff.com](mailto:chummel@bannerwitcoff.com)



[www.bannerwitcoff.com](http://www.bannerwitcoff.com)

© Copyright 2014 Banner & Witcoff, Ltd. All Rights Reserved. The opinions expressed in this publication are for the purpose of fostering productive discussions of legal issues and do not constitute the rendering of legal counseling or other professional services. No attorney-client relationship is created, nor is there any offer to provide legal services, by the publication and distribution of this edition of IP Alert.





**Supreme Court Allows Copyright  
Action, Holds No Laches Defense**

**Ernie V. Linek**

***Banner & Witcoff Intellectual  
Property Alert***

**May 20, 2014**



## Intellectual Property Alert: Supreme Court Allows Copyright Action, Holds No Laches Defense

By Ernest V. Linek

May 20, 2014 — Yesterday, in *Petrella v. Metro-Goldwyn-Mayer, Inc.* (No. 12-1315), the Supreme Court ruled that the doctrine of laches could not be invoked to bar a copyright claim that was brought within the statutorily allowed three-year window from a particular act of infringement — even though the copyright owner had a significant delay (over 18 years) from her inheritance of her father’s copyright in a screenplay first copyrighted in 1963. MGM made the screenplay into the motion picture, “Raging Bull,” based on the boxing career of former world middleweight boxing champion Jake LaMotta and starring Robert De Niro (who won the Best Actor Academy Award), in 1980.

Author Frank Petrella died during the initial copyright term, and by law, the renewal rights in his copyright reverted to his heirs. His daughter, Paula Petrella, renewed the 1963 copyright in 1991, becoming its sole owner. About seven years later, she advised MGM that its continued sale of the movie “Raging Bull” violated her copyright and threatened suit. About nine years later, in 2009, she filed an infringement suit, seeking monetary and injunctive relief limited to acts of infringement occurring in and after 2006.

As a defense to the infringement action, MGM asserted laches based on the 18-plus years during which MGM had continuously marketed the film. In its motion for summary judgment, MGM argued that this time constituted delay that was both unreasonable and prejudicial to MGM. The District Court granted MGM’s motion, holding that laches barred the complaint. The Ninth Circuit affirmed.

The Supreme Court reversed. The Court’s decision resolved a circuit split at the appellate level, where in copyright cases, some courts had applied the laches defense and others had not. The Court held that the lower courts had erred in “failing to recognize that the copyright statute of limitations, §507(b), itself takes account of delay.” *Petrella*, slip op. at 11.

The Copyright Act provides both equitable and legal remedies for infringement: an injunction “on such terms as [a court] may deem reasonable to prevent or restrain infringement of a copyright,” §502(a); and, at the copyright owner’s election, either (1) the “owner’s actual damages and any additional profits of the infringer,” 504(a)(1), which Petrella sought in the case, or (2) specified statutory damages, §504(c).

The Act’s statute of limitations (§507(b)) provides: “No civil action shall be maintained under the [Act] unless it is commenced within three years after the claim accrued.” A claim ordinarily accrues when an infringing act occurs.

However, under the **separate-accrual rule** that attends the copyright statute of limitations, when a defendant has committed successive violations, each infringing act starts a new limitations period.

The *Petrella* opinion emphasizes that the Court has “never applied laches to bar in their entirety claims for discrete wrongs occurring within a federally prescribed limitations period.” *Petrella*, slip op. at 14-15.

Rather, the Court stated that laches is a “gap-filling, not legislation-overriding” measure that is appropriate **only** when there is not an explicit statute of limitations. *Id* at 14.

The *Petrella* ruling is in basic agreement with the position taken by the federal government during oral argument. The government argued that laches should be available only in “exceptional cases” as a defense within the three-year statutory period, and should serve only as a bar to equitable relief, not damages.

Of special interest to patent lawyers, during argument, Justice Ginsburg pointed out that the government’s position was contrary to Federal Circuit precedent in patent cases, which holds just the opposite, namely that laches bars pre-suit damages but not equitable relief. Also of special interest in the opinion is the text leading up to footnote 15 (*Petrella*, slip op. at 12-13). In footnote 15, the Supreme Court makes it fairly clear that the Federal Circuit may be due for another patent law reversal:

The Patent Act states: “[N]o recovery shall be had for any infringement committed more than six years prior to the filing of the complaint.” 35 U.S.C. §286. The Act also provides that “[n]oninfringement, absence of liability for infringement or unenforceability” may be raised “in any action involving the validity or infringement of a patent.” §282(b) (2012 ed.). Based in part on §282 and commentary thereon, legislative history, and historical practice, the Federal Circuit has held that laches can bar damages incurred prior to the commencement of suit, but not injunctive relief. *A. C. Aukerman Co. v. R. L. Chaides Constr. Co.*, 960 F.2d 1020, 1029–1031, 1039–1041 (1992) (en banc). **We have not had occasion to review the Federal Circuit’s position.**

(Emphasis added.) Justice Ginsburg delivered the opinion of the Court, in which Justices Scalia, Thomas, Alito, Sotomayor and Kagan joined. Justice Breyer filed a dissenting opinion, in which Chief Justice Roberts and Justice Kennedy joined. They would have affirmed the appellate decision based on laches.

To subscribe or unsubscribe to this Intellectual Property Advisory,  
please send a message to Chris Hummel at [chummel@bannerwitcoff.com](mailto:chummel@bannerwitcoff.com)



[www.bannerwitcoff.com](http://www.bannerwitcoff.com)

© Copyright 2014 Banner & Witcoff, Ltd. All Rights Reserved. The opinions expressed in this publication are for the purpose of fostering productive discussions of legal issues and do not constitute the rendering of legal counseling or other professional services. No attorney-client relationship is created, nor is there any offer to provide legal services, by the publication and distribution of this edition of IP Alert.



**U.S. Supreme Court Rules in *ABC v. Aereo***

**Rajit Kapur**

***Banner & Witcoff Intellectual  
Property Alert***

**June 26, 2014**



## Intellectual Property Alert: U.S. Supreme Court Rules in *ABC v. Aereo*

By Rajit Kapur

June 26, 2014 — Yesterday, the U.S. Supreme Court decided *American Broadcasting Companies, et al. v. Aereo*. The 6-3 ruling holds that Aereo’s business model of streaming live broadcast television content over the Internet to its users, without a license from those who own the copyright in that content, violates the copyright owners’ exclusive rights to publicly perform the copyrighted works.

But the impact of this case — beyond putting an end to Aereo’s unlicensed live streaming of broadcast TV content — may be relatively limited, despite earlier concerns that the Court’s ruling here could have an impact on cloud computing technologies and other emerging technologies.

### **The Story So Far ...**

In Boston, New York, and other select cities where Aereo has launched its service, Aereo enables its customers to receive and view broadcast television content on their computer or mobile device via the Internet. Aereo charges its users a small monthly fee for access to its service (\$8 or \$12 per month depending on the city), but unlike cable and satellite providers, Aereo does not have a license from – or provide any compensation to – the broadcasters whose signals Aereo captures to provide its service.

As we discussed in our initial alert on this case, many of the issues in this case stem from Aereo’s clever system design, which is seemingly tailored to avoid the provisions of the copyright laws. In particular, Aereo’s signal reception systems include arrays of tiny antennas, each of which are about the size of a dime and can be dynamically assigned to an individual user when a user requests to view a particular broadcast channel. The video signal received by each antenna is individually recorded for only the one specific user to which the antenna has been assigned, allowing Aereo to analogize its system to the rabbit ears antenna and personal digital video recorder (DVR) that each of its users could legally use in their own home to view and record broadcast television. Aereo provides a “watch” function that allows its users to watch live broadcast television content, as well as a “record” function that allows its users to record broadcast television content in the cloud for future playback.

In March 2012, several television networks and broadcasters, including ABC, CBS, NBC Universal, and Fox, sued Aereo for copyright infringement, seeking, among other things, a preliminary injunction on the grounds that Aereo’s service constituted an unauthorized public performance of their copyrighted video broadcasts. In its defense, Aereo argued that it is merely renting equipment to its users — in the form of an individual antenna, receiver, and DVR — and simply providing access to this equipment via the cloud.

## **The Majority Opinion**

At issue in the case is a copyright owner's exclusive right to publicly perform his or her copyrighted work. In deciding this case, the Court therefore had to address whether Aereo "performed" the broadcasters' copyrighted works, and if so, whether it did so "publicly."

In addressing the first question of whether Aereo "performed" the copyrighted work, Justice Breyer, writing for the majority of the Court, analogized Aereo to the community access television (CATV) systems that predated modern cable television.<sup>1</sup> The Court noted that, when Congress enacted the 1976 Copyright Act, Congress amended the copyright laws "to bring the activities of cable systems within the scope of the Copyright Act," and that under these amended laws, "both the broadcaster and the viewer of a television program 'perform,' because they both show the program's images and make audible the program's sounds."<sup>2</sup>

Based on this analysis, the Court rejected Aereo's claim that it is merely an "equipment provider." Instead, the Court determined that "Aereo's activities are substantially similar to those of the CATV companies that Congress amended the Act to reach," essentially holding that Aereo has to play by the same rules as other cable companies, such as the compulsory licensing scheme created by Congress to address the retransmission of copyrighted works by such cable companies.<sup>3</sup>

In addressing the second question of whether Aereo performed the copyrighted works "publicly," the majority rejected Aereo's arguments that its transmission of a "personal copy" of a broadcast video recording to an individual user could not be considered a transmission "to the public" within the meaning of the statute.<sup>4</sup> The Court dismissed the "behind-the-scenes" technological differences that Aereo relied on to distinguish itself from other cable systems, in view of the "regulatory objectives" underlying the relevant law.<sup>5</sup> The Court states that "[i]nsofar as there are differences [between Aereo and other solutions], those differences concern not the nature of the service that Aereo provides so much as the technological manner in which it provides the service."

After concluding that Aereo both "performed" the broadcaster's copyrighted work and did so "publicly," the Court held that Aereo's service violates the broadcasters' exclusive rights in the public performance of their copyrighted works.

## **Justice Scalia's Dissent**

Justice Scalia dissented from the majority of the Court, and his dissenting opinion was joined by Justice Thomas and Justice Alito.

In his dissent, Justice Scalia seemed to find the technological differences between Aereo, on the one hand, and cable systems, on the other, to be of more significance than the majority. For example, in applying the relevant law to Aereo, Justice Scalia argued that because an Aereo user — not Aereo itself — selects a program to watch and activates Aereo's system as a result of this selection, there

---

<sup>1</sup> Majority Opinion at 5.

<sup>2</sup> See Majority Opinion at 7-8.

<sup>3</sup> See Majority Opinion at 8.

<sup>4</sup> See Majority Opinion at 11-12.

<sup>5</sup> See Majority Opinion at 12-13.

is no direct infringement of the public performance right by Aereo. Rather, it is the Aereo user, not Aereo, which “performs” the copyrighted work.<sup>6</sup>

Justice Scalia also argued that the Court, in its majority opinion, has created a “looks-like-cable-TV” standard that disregards other accepted rules and will create confusion in the future.<sup>7</sup> In particular, Justice Scalia criticized the majority’s reliance on “a few isolated snippets of legislative history” in deciding the case by essentially determining that Aereo should be treated like a cable company.<sup>8</sup> Justice Scalia also argued that the technological differences between Aereo’s system and cable systems are significant enough that even Aereo should not satisfy the “looks-like-cable-TV” rule seemingly established by the majority in this case.<sup>9</sup>

Finally, Justice Scalia argued that the majority’s opinion disrupts settled law without making clear what the new rule is or should be in cases like this going forward.<sup>10</sup> Justice Scalia suggests that this might even lead to future confusion in this dispute between the broadcasters and Aereo. For example, as Justice Scalia points out, when this case is returned to the lower court on remand, the lower court will have to consider whether Aereo’s “record” function also runs afoul of the new rule established in this case, since only Aereo’s “watch” function is at issue before the Court here.

Despite reaching the opposite conclusion on the public performance issue, however, Justice Scalia makes clear that his conclusions do not necessarily mean that Aereo’s service complies with the copyright laws. As Justice Scalia observes, the broadcasters have alleged that Aereo is directly and secondarily liable for infringing both their public performance rights, as well as their separate reproduction rights, in the copyrighted works. However, because this appeal arises from the broadcasters’ request for a preliminary injunction, the only issue before the Court at this point in time is whether Aereo is directly infringing the public performance right with respect to the “watch” function.<sup>11</sup> The questions of whether there is secondary liability for infringement of the public performance right, whether the reproduction right has also been violated, and whether Aereo’s “record” function violates either of these rights all still remain to be addressed by the lower court.

Justice Scalia concludes by acknowledging that he shares the majority’s “evident feeling that what Aereo is doing (or enabling to be done) to the Networks’ copyrighted programming ought not to be allowed.”<sup>12</sup> But Justice Scalia believes that the Court should “leave to Congress the task of deciding whether the Copyright Act needs an upgrade,” instead of trying to “bend and twist” the law to reach a “just outcome.”<sup>13</sup>

### **What Does This Mean For The Cloud?**

Perhaps to the relief of those who saw this case as a potential setback for cloud computing technology, the majority opinion took great pains to emphasize what it was not deciding in addition to what it was. And it seems clear that at least one of the many things that was not decided was

---

<sup>6</sup> See Scalia Dissent at 2-6.

<sup>7</sup> See Scalia Dissent at 1.

<sup>8</sup> See Scalia Dissent at 7.

<sup>9</sup> See Scalia Dissent at 8.

<sup>10</sup> See Scalia Dissent at 9.

<sup>11</sup> See Scalia Dissent at 6-7.

<sup>12</sup> Scalia Dissent at 12.

<sup>13</sup> See Scalia Dissent at 13.

whether a cloud storage platform, such as Dropbox or iCloud, would run afoul of the copyright laws' protection of the "public performance" right in providing access to video recordings and other copyrighted content stored by its users.

Indeed, in noting what was not being decided, the Court seemed to recognize some of the ways in which a cloud storage platform might distinguish itself from Aereo and from the result reached in this case. For example, the Court noted that it has "not considered whether the public performance right is infringed when the user of a service pays primarily for something other than the transmission of copyrighted works, such as the remote storage of content."<sup>14</sup> Additionally, in noting that the term "the public" "does not extend to those who act as owners or possessors of the relevant product,"<sup>15</sup> the Court seems to suggest that an instance in which a user of a cloud-based storage platform purchases copyrighted content — and then stores it in the cloud for personal playback on demand — would not implicate the "public performance" right at issue in this case, at least because the user lawfully owns and possesses that content.

Nevertheless, it will be interesting to see what new issues may arise in this case once it returns to the lower court, particularly in view of the concerns raised by Justice Scalia in his dissent, such as how, if at all, the Court's opinion will affect the legality of Aereo's "record" function. For now, however, the majority's limited ruling with respect to Aereo and its technology should not affect — and hopefully will not have a chilling effect on — future development of cloud computing technologies.

To subscribe or unsubscribe to this Intellectual Property Advisory, please send a message to Chris Hummel at [chummel@bannerwitcoff.com](mailto:chummel@bannerwitcoff.com).



[www.bannerwitcoff.com](http://www.bannerwitcoff.com)

© Copyright 2014 Banner & Witcoff, Ltd. All Rights Reserved. The opinions expressed in this publication are for the purpose of fostering productive discussions of legal issues and do not constitute the rendering of legal counseling or other professional services. No attorney-client relationship is created, nor is there any offer to provide legal services, by the publication and distribution of this edition of IP Alert.

---

<sup>14</sup> Majority Opinion at 16-17.

<sup>15</sup> Majority Opinion at 16-17.



# **DESIGN PATENTS**



**Pacific Coast Marine Decision  
Confirms Application of Prosecution  
History Estoppel to Designs**

**John M. Fleming**

***Banner & Witcoff Intellectual  
Property Alert***

**January 10, 2014**

## PACIFIC COAST MARINE DECISION CONFIRMS APPLICATION OF PROSECUTION HISTORY ESTOPPEL TO DESIGNS

By **John M. Fleming**

The Federal Circuit handed down a 3-0 decision on Jan. 8, 2014, in *Pacific Coast Marine Windshields Limited v. Malibu Boats, LLC et al.*, recognizing that the concept of prosecution history estoppel applies to design patents. The decision was authored by Judge Dyk, who was joined by Judges Mayer and Chen.

The Federal Circuit overturned a Middle District of Florida's grant of Malibu Boats' motion for summary judgment of non-infringement, finding that prosecution history estoppel barred the infringement claim. The Federal Circuit held that the principles of prosecution history estoppel apply to design patents, but reversed the district court's summary judgment of non-infringement because the accused infringing design was not within the scope of the subject matter surrendered during prosecution.

In April 2006, the owner and CEO of Pacific Coast filed a design patent application claiming "an ornamental design of a marine windshield with a frame, a tapered corner post with vent holes and without vent holes, and with a hatch and without said hatch." The originally filed figures included multiple embodiments with variations of including or not including a front hatch and including or not including various numbers and shapes of vent holes, as shown below.

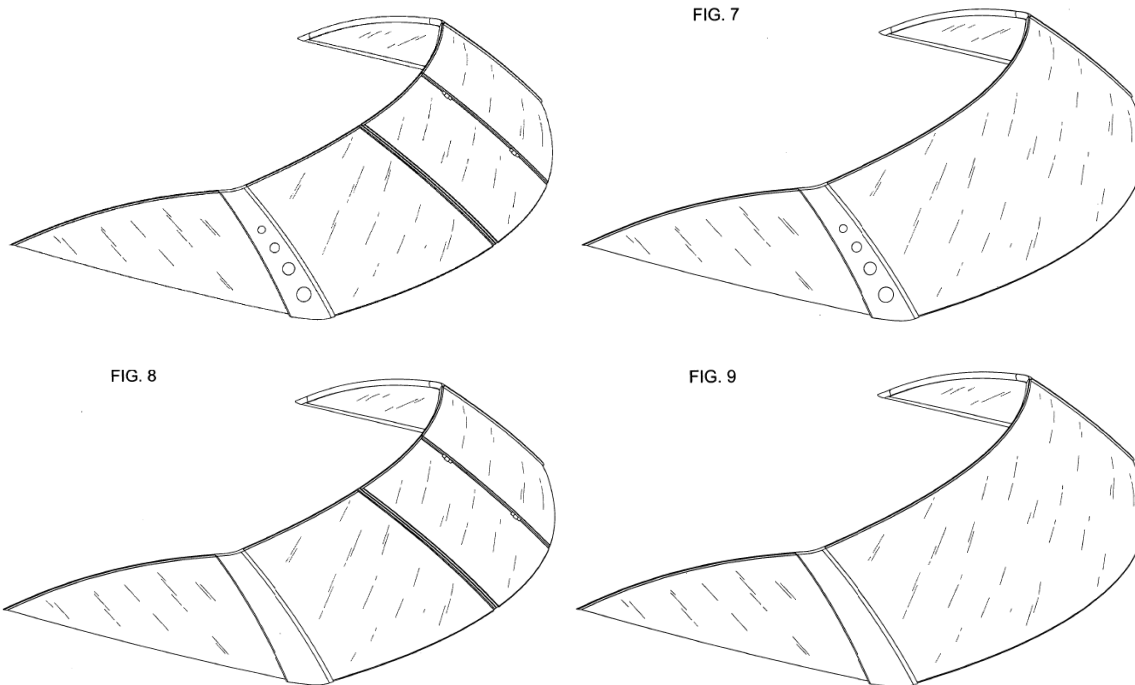
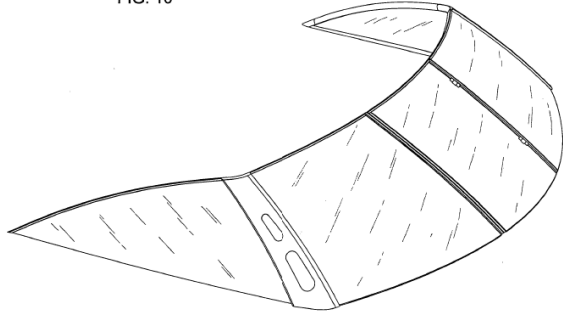
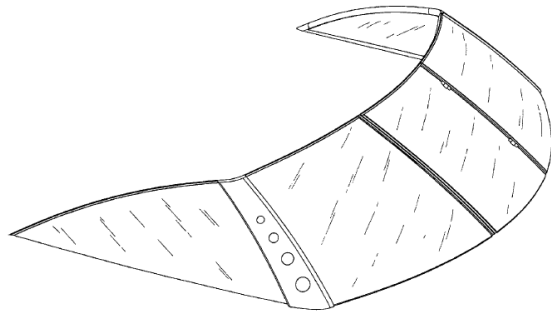

FIG. 10



During prosecution, the Examiner issued a restriction requirement identifying five patentably distinct groups of designs. The applicant elected an embodiment having a front hatch and four circular vent holes, as shown below. The design patent issued as US D555,070 on Nov. 13, 2007.



The inventor later obtained a patent for the design with a hatch and no vent holes (FIG. 8 above) as a divisional of the originally-filed application. That issued as US D569,782 on May 27, 2008. No other application to the other non-elected embodiments was filed.

In 2011, Pacific Coast brought suit in the Middle District of Florida against Malibu Boats alleging infringement of the '070 patent based upon the below boat windshield having a hatch and three trapezoidal vent holes.

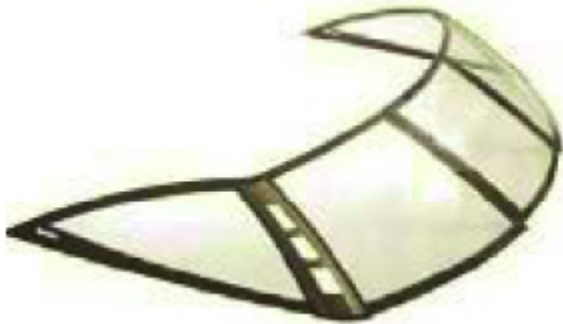

The district court granted Malibu Boat's motion for summary judgment of non-infringement on the ground of prosecution history estoppel because the applicant surrendered the designs reflected in the canceled figures, the accused design is within the territory surrendered between the original claim and the amended claim, and that the patentee failed to overcome the presumption of prosecution history estoppel.

The Federal Circuit started by recognizing that whether the concept of prosecution history estoppel applies to design patents is one of first impression. The Federal Circuit held that prosecution history estoppel clearly applies to design patents as well as utility patents.

Having determined that the principles of prosecution history estoppel apply to design patents, the Federal Circuit turned to answer three questions: (1) whether there was a surrender; (2) whether it was for reasons of patentability; and (3) whether the accused design is within the scope of the surrender. First, the Federal Circuit held that cancelation of figures showing corner posts with two vent holes and no vent holes was a surrender of those designs and that the applicant conceded that the claim was limited to what the remaining figure showed—a windshield with four vent holes in the corner post—and colorable imitations thereof. Then the Federal Circuit held that although the surrender was not made for reasons of patentability (e.g., anticipation, obviousness or patentable subject matter), the surrender was still made to secure the patent. Since the U.S. Patent & Trademark Office limits design patents to a single claim, a surrender resulting from a restriction requirement invokes prosecution history estoppel if the surrender is necessary to secure the patent. Within the design patent context, the Federal Circuit held that a surrender is necessary to secure the patent when a restriction requirement is invoked and not traversed by the applicant. Finally, the Federal Circuit found that prosecution history estoppel does not bar Pacific Coast’s infringement claim. Although the applicant obtained designs on a four circular vent hole configuration and another on a no vent hole configuration, and surrendered a design on a two vent hole configuration, the applicant neither submitted nor surrendered any three-hole design. “Claiming different designs does not necessarily suggest that the territory between those designs is also claimed.”

Having found that Pacific Coast’s infringement claim is not barred against Malibu Boat’s three vent hole configuration, the Federal Circuit reversed the motion of summary judgment of non-infringement and remanded back to the Middle District of Florida.



**Trademarks by Design: Combining  
Design Patents and Trademarks to  
Protect Your Intellectual Property**

**Robert S. Katz, Helen Hill Minsker  
and Erik S. Maurer**

***American Intellectual Property Law  
Association Spring Meeting***

**March 2014**



## Trademarks by Design: Combining Design Patents and Trademarks to Protect Your Intellectual Property

March 2014

### Authors:

- **Robert S. Katz**, Principal Shareholder, Washington, DC – [rkatz@bannerwitcoff.com](mailto:rkatz@bannerwitcoff.com)
- **Helen Hill Minsker**, Principal Shareholder, Chicago – [hminsker@bannerwitcoff.com](mailto:hminsker@bannerwitcoff.com)
- **Erik S. Maurer**, Principal Shareholder, Chicago – [emaurer@bannerwitcoff.com](mailto:emaurer@bannerwitcoff.com)

**Chicago, IL**  
Ten South Wacker Drive  
Suite 3000  
Chicago, IL 60606

**Washington, DC**  
1100 13<sup>th</sup> Street NW  
Suite 1200  
Washington, DC 2005

**Boston, MA**  
28 State Street  
Suite 1800  
Boston, MA 02109

**Portland, OR**  
121 SW Salmon Street  
11<sup>th</sup> Floor  
Portland, OR 97204

[www.bannerwitcoff.com](http://www.bannerwitcoff.com)

## INTRODUCTION

Design patents and trademarks are separate species of intellectual property (IP), but each can provide significant commercial advantages to their owners. Design patents grant the inventor exclusive rights to the invention for a period of fourteen years which will soon be changed to fifteen years. However, at the end of that time, the design invention is dedicated to the public unless it is protected by another intellectual property right. Trademarks, if properly maintained, can exist forever. With the growing importance of IP rights, old ideas, such as combining trademarks and design patents, deserve another look as a means to accomplish this. Moreover, with the Supreme Court's declaration in *Wal-Mart Stores, Inc., v. Samara Brothers, Inc.*, 529 U.S. 205 (2000), that secondary meaning is required before certain types of product designs are entitled to trade dress protection, design patents may be the most effective way to ward off infringers while secondary meaning for trademarks and/or trade dress is established. This article addresses the relationship between design patent protection and trademark protection and described the strategy of using the combination of these rights.

## THE LEGAL FRAMEWORK

The Patent Law provides for the granting of design patents to any person who has invented any new, original and ornamental design for an article of manufacture. Design patents cover the way an article looks, and may be drawn to the shape/configuration of an article, surface ornamentation applied to the article, or a combination of both. A design patent does not need to be directed to the entire article, and claiming a portion of the article is permitted, *In re Zahn*, 617 F.2d 261 (CCPA 1980). During the soon to be fifteen year term, the owner of the patent has the right to exclude others from making an infringing design.

A trademark is any word, name, symbol, or device that serves as an indicator of source. Thus, the shape of article can serve as a trademark provided that all other requirements are met. Although an application to register a trademark can be filed before a mark is actually in use, ultimately trademark rights arise, and can only be maintained, through use of a mark. Federal trademark registrations carry a presumption that the registration is valid and the registrant has the exclusive right to use the mark. The term of a federal registration is ten years, with renewals available in ten-year increments, so long as the mark remains in use.

Both design patents and trademarks are entitled to a variety of statutory remedies, which may include damages, infringer's profits, injunctions, and under certain circumstances, attorneys' fees. Differences relating to injunctive relief are addressed later in this article. However, not all remedies are available under all circumstances, so the facts of a particular case must be reviewed to determine which remedies are possible.

## INTERPLAY BETWEEN DESIGN PATENTS AND TRADEMARKS

In many instances, the same design can be protected by trademark and design patent laws. Examples of well-known design trademarks which also have been the subject of design patents include the DUSTBUSTER® vacuum cleaner, the APPLE iPod® electronic music player, and the NIKE Air Max 1995® shoe upper.



At first blush, combining design patents and trademarks might seem contrary to public policy -- design patents grant a limited period of protection for a design, while trademark law may provide perpetual protection for the same design. However, the CCPA (predecessor to the Court of Appeals for the Federal Circuit) made it clear in *In re Mogen David Wine Corporation*, 328 F.2d 925 (CCPA 1964) and *In re Honeywell, Inc.*, 328 F.2d 925 (CCPA 1974), that trademark rights exist independently of design patent rights. Trademark protection is granted to prevent the public from being confused, while the purpose of design patents is to encourage inventors to develop novel, ornamental designs. However, trademark protection is not extended to designs that are merely ornamental and are not indicators of source. For example, in *In re Owens-Corning Fiberglas Corp.*, 774 F.2d 1116 (Fed. Cir. 1985), a key issue was whether the color pink for fiberglass insulation was merely ornamentation, or whether it was an indicator of source.

The e-commerce revolution has underscored the need to protect IP assets in cyberspace, such as the appearance of computer screen displays and web pages. Designs, such as computer icons, are now commonly protected in various forms through both design patents and trademarks. For example, Sun Microsystems has the coffee cup symbol for its JAVA® product registered as a trademark, and also has a design patent (where the coffee cup is combined with the words “JAVA WORKSHOP”). Thus, a combination of design patent and trademark protection may be the most effective way to protect your trademarks, trade dress and designs in cyberspace.

## FUNCTIONAL V. ORNAMENTAL

A design patent protects the ornamental appearance of the article of manufacture and not its structural or utilitarian features. Articles protected under the design patent laws must be “primarily ornamental” and not “primarily functional,” *L.A. Gear Inc. v. Thom McAn Shoe Co.*, 988 F.2d 1117 (Fed. Cir. 1993). However, in a design patent context, “primarily functional” is not construed as broadly as the phrase might suggest. In determining whether a design is “primarily functional” or “primarily ornamental,” the claimed design is viewed in its entirety, not on a feature-by-feature basis, *L.A. Gear, supra*. If the functional aspects of the design could be accomplished in other ways, it is likely to be primarily ornamental. *Rosco, Inc. v. Mirror Lite Co.*, 304 F. 3d 1373 (CAFC 2002). However, if a design is dictated solely by the functionality of its article of manufacture, it is not patentable, *Best Lock Corp. v. Ilco Unican Corp.*, 94 F.3d 1563 (Fed. Cir. 1996). For most designs, the issue of functionality is not likely to create a problem during the prosecution of the design patent application, but it may arise during litigation.

Trademark protection is not available for designs that are merely ornamental, nor is it available for designs that are de jure functional. In contrast to the design patent process, functionality likely will be raised as an issue during the prosecution of a trademark application, and also may arise during litigation.

If a design is “de jure functional” (functional as a matter of law), it will never be registrable as a trademark. A design is functional as a matter of law if it is “essential to the use or purpose of the article or if it affects the cost or quality of the article.” *TrafFix Devices, Inc. v. Mktg. Displays, Inc.*, 532 U.S. 23, 33, (2001); *Qualitex Co. v. Jacobson Prods. Co.*, 514 U.S. 159, 165, (1995); *Inwood Labs., Inc. v. Ives Labs., Inc.*, 456 U.S. 844, 850, n.10, (1982).

However, a design that is “de facto functional” (functional as a matter of fact), still may be either inherently distinctive or capable of acquiring distinctiveness, and therefore be registrable. For example, in *In re Morton-Norwich Products Inc.*, 671 F.2d 1332 (CCPA 1982), a bottle with a pump for spraying liquid was found de facto functional -- the elements of the mark were used to store and spray liquid -- but potentially registrable as a trademark, provided the owner could prove that the trademark had acquired distinctiveness. (The design in *Morton-Norwich* also was the subject of a design patent.)

It should also be noted that if the product features sought to be protected as a mark were the subject of an expired utility patent, this “adds great weight to the statutory presumption that features are deemed functional until proven otherwise” and that one who seeks such protection “must carry the heavy burden of showing that the feature is not functional.” *TrafFix Devices v. Marketing Displays, Inc.*, 532 U.S. 23 (2001).

Another type of functionality that may also be cited to preclude trademark protection in certain circumstances is “aesthetic functionality.” In contrast to utilitarian functionality, “aesthetic functionality” refers to situations where the feature may not provide a truly utilitarian advantage in terms of product performance, but provides other competitive advantages. (Aesthetic functionality inquiries may look at whether the design would put competitors at a significant non-reputation related disadvantage). Cases in which aesthetic functionality has been addressed cover such diverse products as black outboard motors (*Brunswick Corp. v. British Seagull Ltd.*, 35 F.3d 1527 (Fed. Cir. 1994), *cert. denied*, 514 U.S. 1050 (1995)), red soles on shoes (*Christian Louboutin S.A. v. Yves Saint Laurent America, Inc.*, 696 F.3d 206 (2d Cir. 2012)), red wax seals on whiskey bottles (*Maker’s Mark Distillery, Inc. v. Diageo North America Inc.*, 679 F.3d 410, 418-19 (6th Cir. 2012) and a basketweave pattern on leather goods (*In re Bottega Veneta International S.a.r.l.*, Appl. No. 77219184 (TTAB Sept. 30, 2013)).

Although some types of designs are inherently distinctive, and automatically entitled to trademark protection, for many designs (particularly product configurations), acquired distinctiveness (secondary meaning) must be shown. In *Wal-Mart*, the Supreme Court made a distinction between product designs and packaging designs. While the Court agreed that a packaging design could be inherently distinctive, it held that a product design may only be protectable trade dress if secondary meaning has been demonstrated.

## **OBTAINING TRADEMARK REGISTRATIONS FOR DESIGNS**

The registrability of design trademarks often hinges on demonstrating that the design is not de jure functional. Thus, the PTO and courts look at factors, such as whether the design is the subject of a utility patent or a design patent. If it is the subject of a utility patent, there at least is a presumption that the design is de jure functional and not registrable as a trademark. In contrast, because design patents cover primarily ornamental designs, the existence of a design patent can provide strong evidence that a design is not de jure functional. Advertising for a product is also a factor in determining whether a design is de jure functional. Does the IP owner advertise the utilitarian functions of the design, or does it use advertising to demonstrate that the design is an indicator of source? Additional factors in determining whether a design is de jure functional include whether there are alternative designs available to competitors, and whether the design results from a comparatively cheap, simple method of manufacturing the product.

While the latter two factors may bar even a distinctive design from registration, the first two factors, the presence or absence of a design patent and advertising for a product, can be most useful in establishing a trademark for the product. It often takes many years, and substantial advertising expenditures, before the public will recognize a design as a trademark. Thus, Owens-Corning hired the Pink Panther to urge us to “THINK PINK,” as it sought to register pink as a trademark for fiberglass insulation and United Parcel Service asked us to consider “What Can Brown Do For You?” in its effort to protect the color brown for its delivery services. Such advertising campaigns are rarely successful overnight, so the design patent’s term to exclude can be used to develop public awareness that a particular design is also an indicator of source. Now that the Supreme Court has raised the bar for protecting product designs, the period of exclusivity granted by a design patent becomes even more important in protecting IP rights.

## **DIFFERENT RIGHTS, POTENTIALLY DIFFERENT REMEDIES**

In general, design patent lawsuits are subject to the same precedents that control utility patent lawsuits. To that end, for example, design patent plaintiffs must satisfy the *eBay* requirements to obtain permanent injunctive relief, and courts will not presume the existence of irreparable harm when infringement is found. *eBay Inc. v. MercExchange, L.L.C.*, 547 U.S. 388 (2006).

Notably, irreparable harm requires showing a causal nexus between the infringing design and the plaintiff’s injury. *Apple, Inc. v. Samsung Electronics Co., Ltd.*, 735 F.3d 1352, 1362-63 (Fed. Cir. 2013). For example, in *Apple v. Samsung*, the district court denied permanent injunctive relief because Apple could not show that the infringing design features drove consumer demand for the accused Samsung products. *Id.*

On appeal, the Federal Circuit cautioned against overly rigid standards for demonstrating causal nexus because *eBay* is premised in flexible principles of equity. *Id.* at 1364. Nevertheless, the Federal Circuit affirmed denial of a permanent injunction against Samsung’s design patent infringements, agreeing that “Apple must show some connection between the patented feature and demand for Samsung products,” and the district court’s findings would not be disturbed under the controlling standard of review. *Id.*

Trademarks, in contrast, may yet afford an automatic entitlement to a permanent injunction against on-going violations – provided the asserted mark is famous and liability flows from dilution. Here, the Federal Trademark Dilution Revision Act of 2006 (“FTDA”) provides that the owner of a famous mark is entitled to an injunction against marks that are “likely to cause dilution by blurring or dilution by tarnishment of the famous mark, regardless of the presence or absence of actual or likely confusion, of competition, or of actual economic injury.” 15 U.S.C. § 1125(c)(1).

This situation might have played out in *Apple v. Samsung*, but for the fact Samsung stopped selling phones that were found to dilute Apple’s famous iPhone trade dress before the district court addressed the issue of post-judgment permanent injunctive relief. There, the district court exercised its discretion to deny a permanent injunction because it was undisputed that Samsung voluntarily stopped its diluting conduct. *Apple, Inc. v. Samsung Electronics Co., Ltd.*, 909 F.Supp.2d 1147, 1158 (N.D.Cal. 2012). On appeal, the Federal Circuit affirmed denial of a

permanent injunction against the diluting phone designs, but avoided the direct question of whether the FTDA would otherwise automatically authorize issuance of permanent injunction. *Apple*, 735 F.3d 1373-74, n.9. Instead, the Federal Circuit interpreted Ninth Circuit precedents, concluding that the district court could have issued an injunction notwithstanding Samsung's voluntary cessation, but that the court acted within its discretion. *Id.* at 1375.

## **DESIGN PATENT, TRADEMARK OF BOTH?**

Not all designs warrant obtaining both design patent and trademark protection. The following factors are just some of the relevant considerations in deciding what protection is appropriate:

1. The importance and life expectancy of the design. If the design is of great importance, then both design patent and trademark protection may be warranted. If it will have a relatively short commercial life, then design patent protection alone may be sufficient.
2. The nature of competitors: is this an industry where copying is rampant? If copying is the norm, then obtaining the maximum protection through both design patents and trademark registrations may be critical.
3. Cost of asserting rights: Developing a winning evidentiary record in a trademark case may require extensive surveys and be more costly than preparing the evidence for a design patent case. On the other hand, if the design patent is more narrow than the scope of trademark protection, it may be worth the risk of additional cost to prove trademark infringement.
4. The relative ease/difficulty of registering the design under the trademark and the design patent law. If the design lacks inherent distinctiveness or secondary meaning, then a design patent may provide a quick means of securing protection. Design patents typically issue in 1-1/2 years, while a trademark registration for a mark that faces a functionality objection may face many years of prosecution (or persecution, depending on your viewpoint) before a registration issues.
5. Budget: will the design fit in a single design patent or trademark application, or are multiple applications required? If budget is a factor, look to see whether elements of the design require individual or collective protection, and then determine which type of protection is most economical.
6. Time: Has more than one year passed since the design was on sale or in public use? If so, then design patent protection is precluded by statute, but trademark protection may still be available.
7. If a design is not inherently distinctive, can it be turned into a trademark through a targeted advertising campaign, such as the "THINK PINK" campaign of Owens-Corning? If so, use the design patent's term of exclusivity to develop consumer goodwill. At the very least, use it to obtain the five years of substantially exclusive use needed to register the trademark on the basis of acquired distinctiveness.

8. Audit your IP portfolios regularly. Many changes will occur in the marketplace during the life of a design patent. Look at your design patent portfolio periodically to see whether any of the designs deserve trademark protection.

## **NOW & THEN – THINK AHEAD**

Savvy counsel will explain to their clients how the relative ease of acquiring 14 (or 15) years of design patent protection for a new design contrasts with the rigorous requirements for later proving acquired distinctiveness and perpetual trademark rights in that design. For aspiring soothsayers aiming to predict the next iconic design, keep the following issues in mind.

**Consistently define the design from the outset** – claiming parts of a design in a patent should be consistent, or at least compatible, with future trade dress definitions. Here, issuance of a design patent covering some or all of the future claimed trade dress can bolster non-functionality and distinctiveness arguments.

**Beware functionality** – counsel clients to distinguish functional and ornamental properties of industrial design. Ensure that in-house and outside teams are coordinating on utility and design patent prosecution, and that trademark counsel is engaged where significant new designs are being launched. Regional circuit law controls trade dress functionality analyses and aesthetic functionality should be a consideration. Work with clients to highlight the ornamental, non-functional, and recognizable aspects of industrial designs.

**Be smart with agreements** – trademarks are vessels of goodwill that must be mindfully protected. Design patents, on the other hand, are property rights that can be enforced – or not – as clients and their budgets direct. Beware that failure to police design infringements and licensing of design rights without thought to associated goodwill could defeat future claims to owning protectable trade dress.

These are but some of the considerations counsel should discuss with design-focused clients. In sum, patents and trademarks are different rights that provide different protections at different points in time. Savvy counsel will survey the field of play from thirty-thousand feet well before advising clients about on-the-ground tactics.

In short, analyze whether design patent protection is available, whether trademarks already exist in the designs you have, or whether they can be trademarks by design, and select your protection accordingly.



**The Written Description  
Requirement in U.S. Design Patent  
Prosecution: Background and  
Recent Developments**

**Richard S. Stockton**

***American Intellectual Property Law  
Association Roundtable***

**March 12, 2014**

# The Written Description Requirement in US Design Patent Prosecution: Background and Recent Developments

March 12, 2014

By Richard Stockton, Principal Shareholder, Banner & Witcoff, Ltd. (Chicago)  
[rstockton@bannerwitcoff.com](mailto:rstockton@bannerwitcoff.com), 312-463-5414

---

## Introduction

On February 6, 2014, the United States Patent and Trademark Office (“USPTO”) announced a roundtable to solicit public opinions regarding the written description requirement (“WDR”) as applied to US design patent applications (“DPAs”) in “rare” situations (“Roundtable”).<sup>1</sup> The USPTO scheduled the Roundtable for the afternoon of March 5, and also requested written comments (due March 14).

The Roundtable responds what many design patent practitioners perceive as an unannounced shift to a heightened WDR standard for DPAs. This white paper introduces the WDR for DPAs, summarizes recent developments (including the Roundtable) and then assesses next steps.

## The WDR for DPAs

The legal basis for a WDR rejection is 35 U.S.C. § 112(a). Most DPA WDR rejections arise from (1) amending DPA claim scope (*e.g.*, converting solid “claimed” lines to broken “unclaimed” lines) and/or (2) claiming priority to an earlier application (*e.g.*, under 35 U.S.C. §§ 119 or 120). Here is an example of (1), amending claim scope in a DPA:

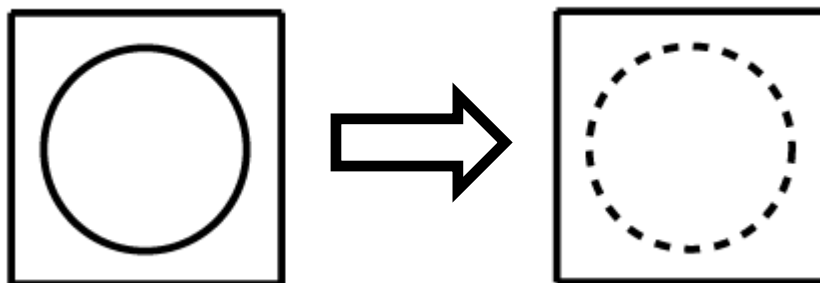

**Figure 1: Amending Claim Scope in a DPA**

In the context of (2), claiming priority, a recent Federal Circuit case summarized DPA WDR law as follows:

---

<sup>1</sup> See 79 Fed. Reg. 7171-73.

The test for sufficiency of the written description, which is the same for either a design or a utility patent, has been expressed as ‘whether the disclosure of the application relied upon reasonably conveys to those skilled in the art that the inventor had possession of the claimed subject matter as of the filing date.’ *Ariad Pharm., Inc. v. Eli Lilly & Co.*, 94 USPQ2d 1161, 1172 (Fed. Cir. 2010) (*en banc*). In the context of design patents, the drawings provide the written description of the invention. *In re Daniels*, 46 USPQ2d 1788 (Fed. Cir. 1998); *In re Klein*, 26 USPQ2d 1133 (Fed. Cir. 1993) (“[U]sual[ly] in design applications, there is no description other than the drawings.”). Thus, when an issue of priority arises under § 120 in the context of design patent prosecution, one looks to the drawings of the earlier application for disclosure of the subject matter claimed in the later application. *Daniels*, 46 USPQ2d at 1789; *see also Vas-Cath Inc. v. Mahurkar*, 19 USPQ2d 1111 (Fed. Cir. 1991).<sup>2</sup>

A key DPA WDR issue is what “reasonably conveys” means, and therefore the extent of options to modify design patent claim scope from an initial disclosure.

WDR rejections are one of two significant species of DPA rejections under 35 U.S.C. § 112.<sup>3</sup> The other species, non-enablement/indefiniteness under 35 U.S.C. § 112(a) and (b), typically arises from (1) unclear figures, such as when detail is too muddy or pixelated, or (2) figures in which the parameters of the detail cannot be discerned. Here is an example of (2):

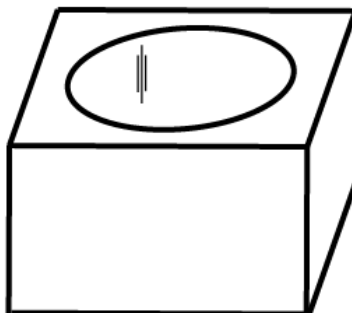

**Figure 2: Simplified Example of Non-Enablement/Indefiniteness**

Assuming *arguendo* that the figure above is the full disclosure in the DPA, and that the three lines within the circle on the top surface correspond to shading (a common convention) to depict a hole in the cube, the DPA may be rejected as non-enabled/indefinite because the depth of the hole is not discernible. The WDR comes into play by limiting the responses available to overcome the non-enablement/indefiniteness rejection by amending the figures. Here, for example, if the applicant tried to overcome the rejection by, *e.g.*, adding a second figure showing different perspective and the depth of the hole, a WDR rejection would likely result:

---

<sup>2</sup> *In re Owens*, 106 USPQ2d 1248, 1250 (Fed. Cir. 2013) (emphasis added) (reh’g *en banc* denied). As discussed in the Post-Script *infra*, *Owens* is arguably limited to a narrow set of facts. But it remains the most recent Federal Circuit case relating to the WDR for DPAs.

<sup>3</sup> The enablement requirement under 35 U.S.C. § 112(a) applies to DPAs but is generally an issue so long as all of the claimed subject matter is visible in the DPA.



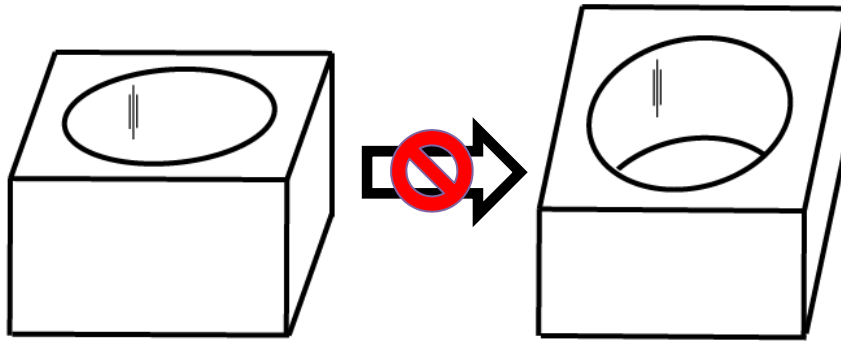

**Figure 3: The WDR Limits Responses to Non-Enablement/Indefiniteness Rejections**

Thus, the WDR is very significant in DPAs because the majority of USPTO rejections are 112 rejections, and the WDR is directly or indirectly involved in most 112 rejections. Empirically, in an informal survey of the file histories of 1049 issued design patents, Professor Dennis Crouch found that 75% of all DPA rejections were 112 rejections (compared to 7% for rejections under 35 U.S.C. §§ 102 and 103).<sup>4</sup>

#### **Design Day 2013 and a Perceived USPTO Policy Shift Regarding WDR Rejections**

Each spring for more than seven years, the USPTO has welcomed the general public for “Design Day,” co-sponsored by the American Intellectual Property Law Association (“AIPPLA”), Intellectual Property Owners Association (“IPO”), American Bar Association and Industrial Designers Society of America (“IDSA”).<sup>5</sup> Design Day typically features presentations from USPTO employees and design practitioners.

At Design Day 2013, a presentation by the USPTO Design Practice Specialist, Mr. Joel Sincavage, titled “More About the Written Description Requirement of 35 USC 112(a)” caused controversy. USPTO design patent examiners consult with Mr. Sincavage regarding, *e.g.*, whether to make a WDR rejection. The controversy reached a crescendo with the following slide:

---

<sup>4</sup> See <http://patentlyo.com/patent/2010/01/design-patent-rejections.html>

<sup>5</sup> See, *e.g.*, <http://www.aipla.org/learningcenter/Pages/2014-USPTO-Design-Day.aspx>



## Designs in the New Digital Age

### Baby bottle strap

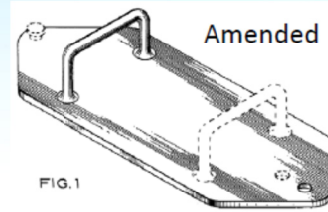
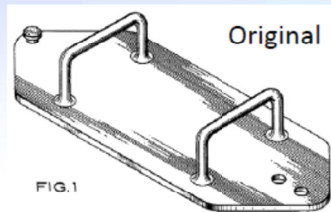

The design left over, after the amendment, was not recognizable prior to the amendment.

Does the description clearly allow persons of ordinary skill in the art to recognize that the inventor invented what is claimed?

See *In re Gosteli*, 872 F.2d 1008, 1012, 10 USPQ2d 1614, 1618 (Fed. Cir. 1989).

Design Day 2013

United States Patent and Trademark Office



8

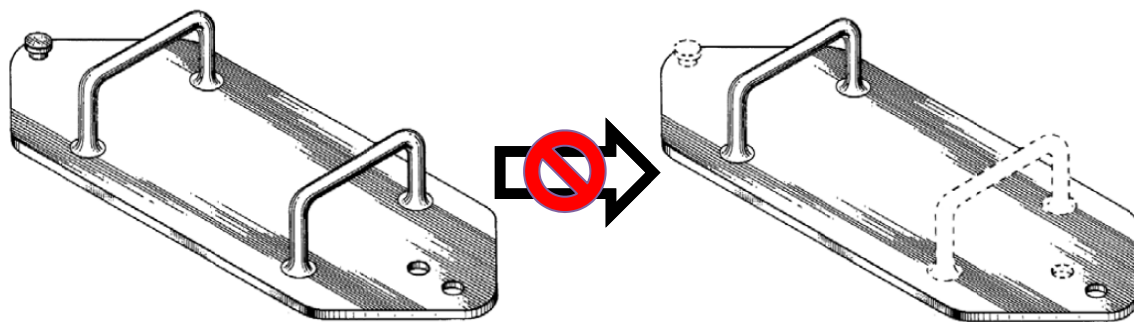

**Figure 4: Controversial Slide from Design Day 2013 Presentation**

In a nutshell, Mr. Sincavage opined that if the claim scope were amended to disclaim the bar, nub and hole (*i.e.*, go from left to right above), then a WDR rejection should be made.<sup>6</sup>

A heated Q&A period followed, with design patent practitioners responding (and some fuming and flailing) that the presentation defied years of USPTO practice (evidenced in the public prosecution histories of thousands of US design patents), and questioning the need for an abrupt policy shift (as well as a lack of transparency and proper procedure in making the shift).

<sup>6</sup> In response to a question after his presentation, Mr. Sincavage opined that amending from right to left, *i.e.*, from claiming a subset to claiming every element, would likely not trigger a WDR rejection.

Empirically, and even before Design Day 2013, the consensus of design patent practitioners has been that the WDR standard for DPAs has been heightened. Some design patent practitioners go so far as to assert that even rudimentary amendments of single features that were once entered without a second thought are now subject to WDR rejections. In this regard, it is also noted that the WDR standard for DPAs in the two-dimensional computer icon and graphical user interface (“GUI”) area has long been more rigid than the general WDR standard for DPAs, although the perceived policy shift has moved the general WDR standard closer.<sup>7</sup>

### **The Roundtable on March 5**

The Roundtable arose from the Design Day 2013 controversy.<sup>8</sup> The USPTO conducted the Roundtable around a U-shaped table in the USPTO’s Madison Auditorium. Four USPTO employees (including a brave Mr. Sincavage) and seven designated public presenters sat at the table:

- **Mr. Paul Bowen** (Partner, Nixon & Vanderhye)
- **Ms. Tracy Durkin** (Director, Sterne, Kessler, Goldstein & Fox)
- **Mr. William Fryer** (Professor Emeritus, University of Baltimore)
- **Mr. David Gerk** (Patent Attorney, USPTO Office of Policy and International Affairs);
- **Mr. Brian Hanlon** (USPTO Director of the Office of Patent Legal Administration); and
- **Mr. Robert Katz** (Principal Shareholder, Banner & Witcoff, Ltd.)
- **Mr. Bob Olszewski** (USPTO Director for Technology Center 2900 (the design examination unit));
- **Mr. Perry Saidman** (Principal, Saidman DesignLaw Group)
- **Mr. Joel Sincavage** (USPTO Design Practice Specialist, Technology Center 2900)
- **Mr. Richard Stockton** (Principal Shareholder, Banner & Witcoff, Ltd.)
- **Mr. Cooper Woodring** (Past President, IDSA)

Some other commenters also sat at the table, and approximately 40-50 other members of the public and USPTO employees were in the audience. The USPTO also webcast the Roundtable live.

### *Roundtable Topics in the Federal Register Notice*

As stated previously, the Federal Register notice for the Roundtable sought public opinion regarding WDR in “certain limited situations” in which “only a subset of elements of the original

---

<sup>7</sup> In the GUI DPA context, and setting aside novelty, the amendment shown in Figure 1 likely would receive a WDR rejection. The amendment would be less likely to receive a WDR rejection if it were part of a set of figures relating to a cube having a punched-out cylinder as described previously.

<sup>8</sup> See 79 Fed. Reg. at 7172 (“During discussions between the Office and members of the public attending Design Day, some attendees requested that the Office reconsider how the written description requirement under 35 U.S.C. 112(a) is applied to design applications where only a subset of elements of the original disclosure are shown using solid lines in an amendment or continuation application. In order to obtain a better understanding of the attendees’ concerns, the Office is hosting this roundtable event.”)

disclosure are shown using solid lines in an amendment or in a continuation application.”<sup>9</sup> In this limited context, the bulk of the remainder of the notice sought public input regarding:

whether it would be useful for design examiners to consider any of the following factors in determining whether an amended/continuation design claim, which includes only a subset of the originally disclosed elements (no new elements are introduced that were not originally disclosed), satisfies the written description requirement. These factors would only be applied by design examiners in the rare situation where there is a question as to whether an amended/continuation design claim satisfies the written description requirement. The factors are as follows:

- (1) The presence of a common theme among the subset of elements forming the newly identified design claim, such as a common appearance;
- (2) the subset of elements forming the newly identified design claim share an operational and/or visual connection due to the nature of the particular article of manufacture (e.g., set of tail lights of an automobile);
- (3) the subset of elements forming the newly identified design claim is a self-contained design within the original design;
- (4) a fundamental relationship among the subset of elements forming the newly identified design claim is established by the context in which the elements appear; and/or
- (5) the subset of elements forming the newly identified design claim gives the same overall impression as the original design claim.<sup>10</sup>

In the notice, the USPTO also sought public input regarding:

- “any additional factors, not listed above, that would be useful for design patent examiners to consider”;
- “the potential advantages and/or disadvantages of using such a factors-based approach”;
- and
- “whether there are mechanisms applicants can use to demonstrate that they had possession of designs claimed in future amendments/continuation applications at the time their original applications were filed,” such as “whether use of a descriptive statement in the originally-filed application (e.g., that specifically identifies different combinations of elements which respectively form additional designs) could be a meaningful way for applicants to demonstrate that they had possession of designs claimed in future amendments/ continuation applications.”<sup>11</sup>

#### *Actual Discussion at the Roundtable*

Mr. Gerck emceed the Roundtable, and public presentations began after an introduction by Mr. Olszewski. Here is a quick summary of the public presentations in chronological order:

---

<sup>9</sup> *Id.*

<sup>10</sup> *Id.*

<sup>11</sup> *Id.* at 7172-73.

- **Ms. Durkin:** The current WDR standard defies longstanding USPTO practice; making WDR rejections in *Ex Parte Quayle* actions (where prosecution on the merits is closed and thus where applicants’ ability to respond substantively is limited), is further unfair.
- **Mr. Stockton, on behalf of AIPLA:** If factors must be used in “rare situations”, then “factor infusion” into everyday DPA practice must be avoided. Some ways to avoid “factor infusion” include placing the burden on the USPTO design examiner to establish a “rare situation,” providing examples to applicants and examiners of amendments that satisfy WDR and revising the Manual of Patent Examining Procedure (“MPEP”).
- **Mr. Woodring:** Noting that he was the only designer presenting at the Roundtable, stated that the factors do not track how a designer thinks, and also commented that the factors will creep into design patent litigation even when non-“rare situation” design patents are at issue.
- **Mr. Bowen:** Proposed having a grid system over DPA figures to establish written description support for amendments tracking the grid.
- **Mr. Katz, on behalf of US Section of International Federation of Intellectual Property Attorneys (FICPI):** Characterized prior case law invoking the WDR, including *Racing Strollers v. TRI Industries*,<sup>12</sup> noting that if something is disclosed, then WDR is satisfied. Mr. Katz also asserted that the factors carve out a subset of previously acceptable WDR situations in violation of Federal Circuit precedent.
- **Mr. Saidman:** The current WDR standard for DPAs is inconsistent with utility patent application practice (example provided). The USPTO should move to a “reasonably identifiable” WDR standard for DPAs.
- **Mr. Fryer:** General comments in view of *In re Daniels* and other cases regarding the correct approach to the WDR.

No public presenters supported the factors, and the presentations (and subsequent comments) generally tilted toward objections to and inconsistencies with the heightened WDR standard overall (even in non-“rare situations”).<sup>13</sup> At one point, the USPTO was asked to identify the problem that led to the heightened WDR standard. Mr. Sincavage responded to the effect that it was not fair for applicants to be able to claim any conceivable subset of elements (*e.g.*, a door handle and a headlight and a bumper from a solid-line disclosure of an entire car). Underlying this response is what appears to be a concern that the public should have fair notice of what it can and cannot do, especially when an amendable continuing application remains pending.

In this regard, design patent practitioners acknowledged that “gaming the system” with spurious amendments should not be allowed. While a longstanding generalized maxim of US design prosecution practice has been that solid lines may be converted to dotted lines and vice-versa, if the maxim was indeed this simple then it would be very easy to “game the system.” On this point, Mr. Stockton’s presentation included a spurious amendment example in which he asserted a WDR rejection would be proper:

---

<sup>12</sup> *Racing Strollers Inc. v. TRI Industries Inc.*, 11 USPQ2d 1300 (Fed. Cir. 1989)

<sup>13</sup> One public commenter noted that the broadening reissue process allows conversion of solid lines to dotted lines in ways that seem inconsistent with the heightened WDR standard for DPAs.

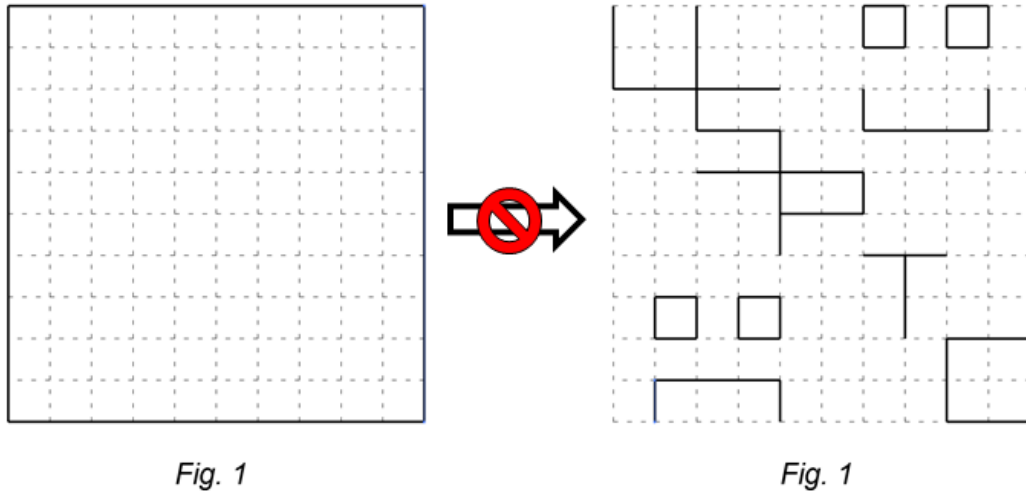

(note: no descriptive statement)

**Figure 5: Example of a WDR-violating Spurious Amendment**

The USPTO has suggested that spurious “gaming the system” amendments have already been attempted, and everybody seems to agree that they should not be allowed. However, disagreement begins to arise when “real world” examples such as the baby strap in Figure 4 *supra* are considered.

After the public presentations, there was a brief discussion regarding “real world” additional examples the USPTO provided.<sup>14</sup> No public presenters asserted that the examples would violate the WDR.

Another issue underlying the Roundtable is prosecution efficiency, for the USPTO and applicants. As a result of a heightened WDR standard, the USPTO stated that it is seeing an increase of DPAs with numerous embodiments (each corresponding, for example, to a potential claim scope that otherwise might be prohibited by the WDR if the claim scope were instead introduced by amendment) and/or lengthy descriptive statements describing various and sundry claim scopes that inventors possessed.<sup>15</sup> These DPAs have the potential to dramatically decrease examination efficiency, especially in view of design examination fees being fixed, and an increase in DPA filings:

<sup>14</sup> See [http://www.uspto.gov/patents/init\\_events/additional\\_ex\\_2014.pdf](http://www.uspto.gov/patents/init_events/additional_ex_2014.pdf).

<sup>15</sup> In the Federal Register notice, the USPTO sought comments regarding such descriptive statements. See 79 Fed. Reg. at 7173.

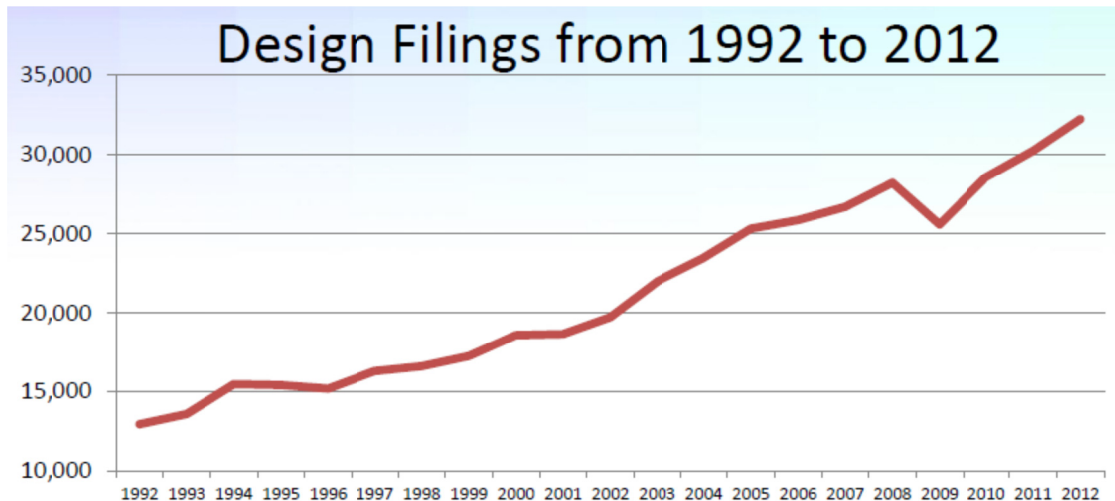

**Figure 6: DPA Filings are Increasing<sup>16</sup>**

On the applicant side, obviously these DPAs are increasing attorney and drafting fees as well.<sup>17</sup> Mr. Bowens’ presentation showed an example of a more complex filing strategy (namely, using a grid system over DPA figures to establish written description support for any amendments that track the grid). This presentation probably caused some unease about prosecution efficiency, especially as no clear precedent exists to prohibit such a strategy.

**Conclusion and Next Steps**

The USPTO agreed to digest public comments from the Roundtable, and said it looked forward to receiving written comments (due March 14). Both AIPLA and IPO plan to submit written comments that will likely reflect the general “anti-factor” public consensus at the Roundtable, and that will also go beyond “rare situations” to proactively address how to fix current WDR policy for DPAs. Other written comments from public presenters and commenters are expected as well.

It is anticipated that the USPTO will then issue another Federal Register notice relating to WDR policy for DPAs, perhaps as a basis for MPEP amendments. In doing so, design patent practitioners hope that WDR policy reflects the strong public consensus against heightened WDR standards in effect, while recognizing a need to prevent “gaming the system.” Put another way by a public commenter at the Roundtable via telephone, Mr. Chris Carani from McAndrews, Held & Malloy, flexibility for amendments is “a virtue not a problem” in the US design patent system and should not be cast aside because of bad apples seeking to “game the system.”

It is also respectfully submitted that the determiner of what is “fairly” disclosed in DPAs—at least in close situations in which reasonable people can disagree—should not be a single design practice specialist at the USPTO, and that more decision-making authority about WDR, at least in typical situations, should be returned—expressly or otherwise—to design patent examiners.

<sup>16</sup> Extracted from Mr. Olszewski’s presentation at Design Day 2013 titled “State of the Technology Center.”

<sup>17</sup> At the Roundtable, it was pointed out that this system will disadvantage smaller entities that lack resources to file DPAs with numerous embodiments and lengthy descriptive statements.

Anonymous feedback from design patent examiners to design practitioners suggests such a retransfer of authority would be welcomed.

Moving forward, Design Day 2014 is scheduled for April 8, 2014. It seems virtually impossible to have the anticipated Federal Register notice released before then, but perhaps the USPTO will summarize the Roundtable and provide an update. We also understand that a Roundtable regarding GUI DPAs is being planned, of which the most significant topic for discussion is 112.

In conclusion, the ball is in the USPTO's court regarding the fate of the current WDR standard, but design patent practitioners hope the standard will be relaxed, and that there will be a return to more flexibility for DPA amendments and priority claims.

#### *Post-Script on In re Owens and the Heightened WDR Standard*

As a final note, some design patent practitioners suspected that the heightened WDR standard was a direct result of the *In re Owens* case, where the Federal Circuit upheld the USPTO's WDR rejection of an amendment relating to the highlighted unclaimed boundary line:

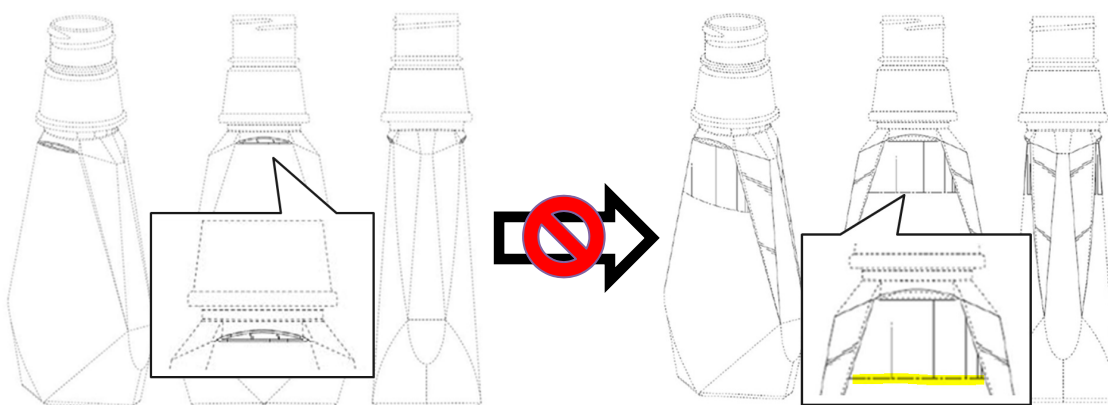

**Figure 7: The Prohibited Amendment in *In re Owens***

Now that the dust has settled, design patent practitioners generally believe that *Owens* is limited to its facts, namely that the addition of the unclaimed boundary line in a seemingly arbitrary location as shown (*i.e.*, across the front facet of the bottle) without any basis in the DPA is prohibited. This ruling generally followed then-existing USPTO practice, although (and as was pointed out in an amicus brief in *Owens*) some design patents have issued despite such amendments. As such, there is some conjecture that the applicant in *Owens* sought to expand the scope of WDR-compliant amendments available to applicants. At any rate, the *Owens* amendment is atypical, and now *verboten* in view of the Federal Circuit ruling, and concerns are more focused on heightened WDR standards that seem to be blocking amendments that were once acceptable.

Ultimately then, most design patent practitioners do not see a correlation between *Owens* and heightened WDR standards. In fact, some statements in *Owens* may actually help deflate the heightened WDR standard. For example, in assessing “whether, and under what circumstances,



Owens could introduce an unclaimed boundary line on his center-front panel and still receive the benefit of § 120,” the Federal Circuit stated that

In our view, the best advice for future applicants was presented in the PTO’s brief, which argued that unclaimed boundary lines typically should satisfy the written description requirement only if they make explicit a boundary that already exists, but was unclaimed, in the original disclosure. Although counsel for the PTO conceded at oral argument that he could not reconcile all past allowances under this standard, he maintained that all future applications will be evaluated according to it.<sup>18</sup>

Here, the Federal Circuit seems to have acknowledged the general maxim and longstanding prior USPTO practice that solid lines may be converted to dotted lines without violating the WDR.<sup>19</sup> In addition, and with reference to the color-coded Figure 8 below, the following “best advice” can be gleaned from the USPTO’s brief:

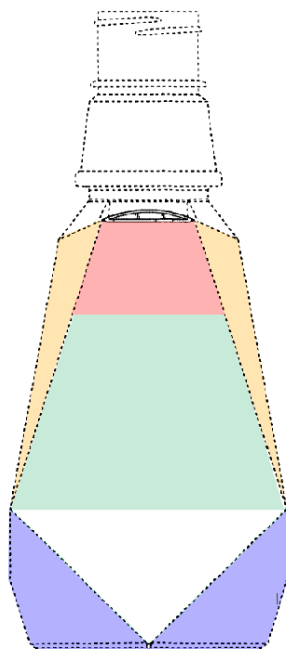

**Figure 8: Actual and Exemplary Amendments  
Characterized in the USPTO’s Brief**

- **“Adding” a Partial Facet Area Not Based on the Ends of Existing Lines (Red):** This amendment was the crux of *Owens*. The Federal Circuit upheld the WDR rejection.
- **Removing Full Facet Areas from the *Parent Application as Filed* (e.g., Blue):** “. . . [D]isclaiming clearly visible portions of the original design [e.g., blue areas] is quite different from disclaiming an arbitrary [red] portion of the front panel that was not

<sup>18</sup> *Owens*, 106 USPQ2d at 1252. The referenced oral argument is available at <http://oralarguments.cafc.uscourts.gov/default.aspx?fl=2012-1261.mp3> (some pertinent dialogue between the court and the USPTO Associate Solicitor, Mr. William LaMarca, begins at the 15:00 mark).

<sup>19</sup> As noted before, of course, there must be some limits to this maxim or else spurious amendments such as what is shown in Figure 5 *supra* would be permissible.

separately identifiable in the original disclosure, resulting in a claim with a new design feature—a trapezoidal section—not previously disclosed.”<sup>20</sup> While the USPTO’s brief did not identify specific facet areas when making this statement, the reduction from all facet areas to the two orange facet areas (which was not objected to) suggests that applicants should be able to amend figures to claim many subsets of facet areas (*e.g.*, an amendment from an entire bottle in solid lines to blue and orange facet areas only, to orange facet areas only etc.).<sup>21</sup>

- **Adding Full Facet Areas from the Application as Filed (*e.g.*, Orange):** “But as the Examiner correctly found, the ‘narrow [orange] triangular areas are clearly recognizable in the original disclosure,’ whereas the [red] trapezoidal area ‘was not originally illustrated.’”<sup>22</sup> Similarly, this part of the amendment was not objected to.
- **Adding a Partial Facet Area Based on the Ends of Lines (*e.g.*, Red and Green):** The MPEP states that “Where no boundary line is shown in a design application as originally filed, but it is clear from the design specification that the boundary of the claimed design is a straight broken line connecting the ends of existing full lines defining the claimed design, applicant may amend the drawing(s) to add a straight broken line connecting the ends of existing full lines defining the claimed subject matter.”<sup>23</sup> The USPTO’s brief stopped short of saying this MPEP statement was inconsistent with the WDR. Instead, the USPTO’s brief asserted that “. . . as the Examiner found, the broken boundary line that Owens added in this case did not connect the ends of two solid lines and therefore was not the type of amendment explicitly permitted by the MPEP.”<sup>24</sup> By contrast, the Federal Circuit took a dimmer view of MPEP § 1503.02, commenting that “[w]ere this the rule, it might be acceptable for Owens to bisect his front panel with a broken line along the pentagon’s widest point [*i.e.*, along the top edge of the green triangle]. However, it seems that such a boundary would simply outline a larger trapezoidal area, and so the resulting claim would suffer from the same written description problems . . . .”<sup>25</sup> Still, there seems to be some room for end-to-end claiming that does not track prior lines. In this regard, the Federal Circuit also understood that Owens and the USPTO were in agreement “that a design patentee may, under certain circumstances, introduce via amendment a straight broken line without adding new matter, even ‘[w]here no [corresponding] boundary line is shown in a design application as originally filed.’”<sup>26</sup>

In the long term, *Owens* may be best remembered for helping to clarify what applicants are allowed to do with amendments, versus what they cannot do. It is hoped that the USPTO considers these suggestions in its *Owens* brief, and returns to more flexibility for DPA amendments and priority claims.

---

<sup>20</sup> Appellee’s Brief at 27-28.

<sup>21</sup> It is not unreasonable to believe that at least some of these amendments that seem allowable in *Owens* would not be allowed under the USPTO’s heightened WDR standard.

<sup>22</sup> Appellee’s Brief at 27. The facet area just above the red area was also removed.

<sup>23</sup> MPEP § 1503.02.

<sup>24</sup> Appellee’s Brief at 23.

<sup>25</sup> *Owens*, 106 USPQ2d at 1252.

<sup>26</sup> *Id.* at 1251 (quoting MPEP 1503.02).



**Virtual Design Theft Update: 3D  
Printing**

**Robert S. Katz and Sean J. Jungels**

***Banner & Witcoff Intellectual  
Property Update***

**September 19, 2014**

## VIRTUAL DESIGN THEFT UPDATE: 3D PRINTING



BY ROBERT S.  
KATZ AND SEAN  
J. JUNGELS

*Virtual design theft*  
— a term coined by

Banner & Witcoff in a 2009 Innovation Journal article — is the unauthorized creation, sale or use of a digital model of a real-life design. That 2009 article previewed the alarming rate at which virtual design theft occurred in the digital world and the potential intellectual property protections that could successfully stop it. Five years later, this article takes a look at how virtual design theft has further expanded into the rapidly growing market of 3D printing and whether the law of design patents, copyrights and trademarks has evolved to effectively combat the problem.

**“With the addition of 3D printers, virtual design theft may now result in both the unauthorized digital use of a design and the unauthorized creation of a 3D physical object of that design.”**

### 3D PRINTING

3D printing is the process of making a three-dimensional object from a digital file. Engineers and designers have been using 3D printers to make prototypes quickly and cheaply for many years before investing significant amounts of money and resources to produce actual products at a factory. As 3D printers have become more sophisticated and reliable, they are now also being used to make final products. For this reason, the public has become more intrigued by 3D printers and their potential capabilities to make a multitude of objects in one’s own home. Although it is still rare to even know someone who owns a 3D printer, let alone in their own home, companies are

heavily investing in this technology to make affordable, consumer-oriented 3D printers (several models are currently priced less than \$1,000, with some priced as low as a few hundred dollars) with the hopes that they will become common household items in the next five to ten years.

So what will people do with 3D printers in the confines of their own home? Most likely the same thing that people did with music and movies when they were first digitalized — share copies of their 3D digital design files. For example, to fill the growing demand for 3D printing designs, people are creating realistic models of existing designs and also creating new designs. They sell these models through specialized websites, such as

<https://digitalstore.makerbot.com/> and [www.turbosquid.com](http://www.turbosquid.com). Even mainstream websites, such as [www.amazon.com](http://www.amazon.com), now have their own 3D printing stores. Some of the computer models on these sites are impressively realistic and have been created using 3D scanner technology or CAD software. While many of these digital models may be authorized, after a quick review of them, it is clear that there are many unauthorized digital models. And even if an authorized design is purchased, the purchaser is then easily able to make unauthorized uses by sharing the digital file of the design with others and making more than one 3D print of the design. Thus, just as the marketplace for the exchange and sale of

**MORE ▶**

[DESIGN THEFT, FROM PAGE 13]

unauthorized music and movie digital files quickly grew, the marketplace for exchanging and selling unauthorized digital design files is following suit.

With the addition of 3D printers, virtual design theft may now result in both the unauthorized digital use of a design and the unauthorized creation of a 3D physical object of that design. The rise and expansion of virtual design theft continues to pose two main questions: (1) Is it illegal? (2) Can the owner of the original design stop it? The answers to these questions are still developing and depend on a number of factors. For example, potential avenues to combat virtual design theft include design patents, copyrights and trademarks. Each is applicable in only selected circumstances, and each has its own strengths and weaknesses. A number of enforcement efforts have recently shed light on how patents, copyrights and trademarks may protect against virtual design theft.

### DESIGN PATENTS

Whether a 3D virtual design would infringe a design patent was tested for the first time in *P.S. Products Inc. et al. v. Activision Blizzard Inc. et al.*, Case No. 4:13-cv-00342-KGB (E.D. Ark., June 5, 2013). P.S. Products sued Activision for patent infringement of U.S. Design Patent No. D561,294 (“the ‘294 patent”) directed to a design for a stun gun in the shape of brass knuckles. Activision’s video game, “Call of Duty: Black Ops II,” included a virtual stun gun weapon that could be held as brass knuckles in the game. Notably, the virtual stun gun weapon did not remotely resemble the design in ‘294 patent.

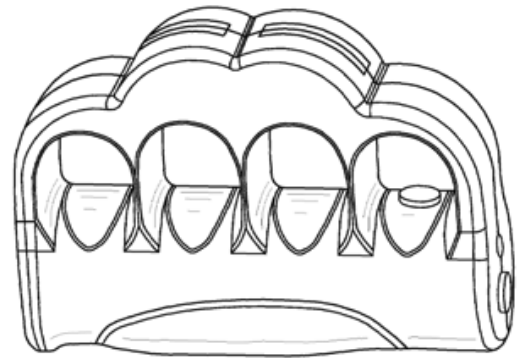

Comparison of P.S. Products’ Patented Design (top) with Image of Activision’s Virtual Weapon (bottom)

**“A number of enforcement efforts have recently shed light on how patents, copyrights and trademarks may protect against virtual design theft.”**

The court did not focus on these stark visual differences, however, and instead granted Activision's motion to dismiss for failure to state a claim because "[n]o reasonable person would purchase defendants' video game believing that they were purchasing plaintiffs' stun gun." The patentee in this case, however, failed to present its strongest argument to the court, *i.e.*, that based on the language of Section 271 of the design laws, a design patent protects the design, not the underlying physical article of manufacture embodying the design. So while this case gives virtual design thieves some initial support for their side of the argument, other courts may still likely side with design patentees on this issue.

## COPYRIGHT

The owner of a valid copyright that covers a design should have a very strong case against a virtual design thief. In copyright lingo, a 3D model is a copy or derivative work of the original. (Fair use as a defense to copyright infringement should also be considered, but it is beyond the scope of this article.) The toughest hurdle for copyright protection of designs is the separability test. The separability test permits copyright protection only for designs that incorporate graphic, pictorial or sculptural features that are conceptually or physically separable from the utilitarian aspects of the product. In one well-known decision, the U.S. Supreme Court found that a lamp base shaped like a human figure was protectable as a sculptural work. In another case, the court found that artwork as part of an ornate belt buckle was protectable. Copyright protection is commonly found in designs containing original surface ornamentation because the surface ornamentation is often times conceptually separable from the product. However, the opposite proposition is also true: designs that are not separable from their underlying article will not be protectable.

Additionally, a digital design based on an actual physical object may not warrant copyright protection. For example, in *Meshwerks, Inc. v. Toyota Motor Sales U.S.A., Inc.*, No. 06-cv-97, 2006 U.S. Dist. LEXIS 65641 (D. Utah, Sept. 12, 2006), Meshwerks created two-dimensional representations of Toyota vehicles for advertisements. When Toyota used the 2D digital files for more than one advertisement, Meshwerks sued Toyota for copyright infringement. The court held that Meshwerks' 2D digital files did not meet the originality requirement for copyright protection because "the digital models created by Meshwerks correspond to the Toyota vehicles they were intended to represent" and thus were merely simple reproductions and not original.

Even though originality is required for a design to be entitled to copyright protection, the threshold is fairly low. In *Osment Models, Inc. v. Mike's Train House, Inc.*, No. 2:09-CV-04189-NKL, 2010 WL 5423740 (W.D. Mo., Dec. 27, 2010), the court held that there may be copyright protection for 3D digital files based on actual buildings that were scaled in size and had some visual aspects changed, resulting in "models [that] do not appear to be mere replications of other objects in a different medium." Thus, in certain cases, a 3D scan of a physical object in the public domain that is modified in more than a trivial way may warrant copyright protection.

## TRADEMARKS

Two categories of trademarks can provide relevant protection against virtual design theft: marks used on or in conjunction with the product, such as the name or logo of the product or manufacturer, and product configuration trade dress. In order to register a product configuration trade dress, the owner needs to show that the product configuration has acquired distinctiveness.

**MORE ►**

[DESIGN THEFT, FROM PAGE 15]

Distinctiveness is acquired by substantially exclusive and continuous use of the mark in commerce such that the primary significance of the product configuration, in the minds of the consumers, is the product's source.

Trademark law will not prevent the design of a new product from being copied until it has acquired distinctiveness. If the design is copied early on, then trademark law will never protect the design because it will not be uniquely associated with a single source. One strategy is to obtain a design patent to prevent similar designs from entering the market so that the product design acquires distinctiveness.

The usual test for trademark infringement is whether there is a likelihood of confusion about the source, sponsorship, affiliation or endorsement of a product. The facts applicable to a likelihood of confusion analysis will likely be different for the website selling the unauthorized digital design files and, for example, a video game maker using the models and selling the video game. The websites selling these files use trademarks,

such as manufacturer and model names, as "tags" that enable searching. It should also be noted that in some circumstances, trademark dilution may be a viable cause of action in situations where virtual design theft has occurred and the trademark has reached a requisite level of fame.

## CONCLUSION

Virtual design theft has significantly grown over the past five years and with the emerging market for 3D printing, it will continue to occur at an increasing rate. The success of enforcement efforts of design patent, copyright and trademark laws is still uncertain and depends on a number of case-specific facts. Thus, while companies affected by the advent of 3D printing may eventually decide to follow the music and entertainment industry by changing their business models to adapt to the digitalization of their product, well planned procurement and enforcement strategies of intellectual property will be important in the interim to protect their current business models against virtual design theft. ■

# LITIGATION



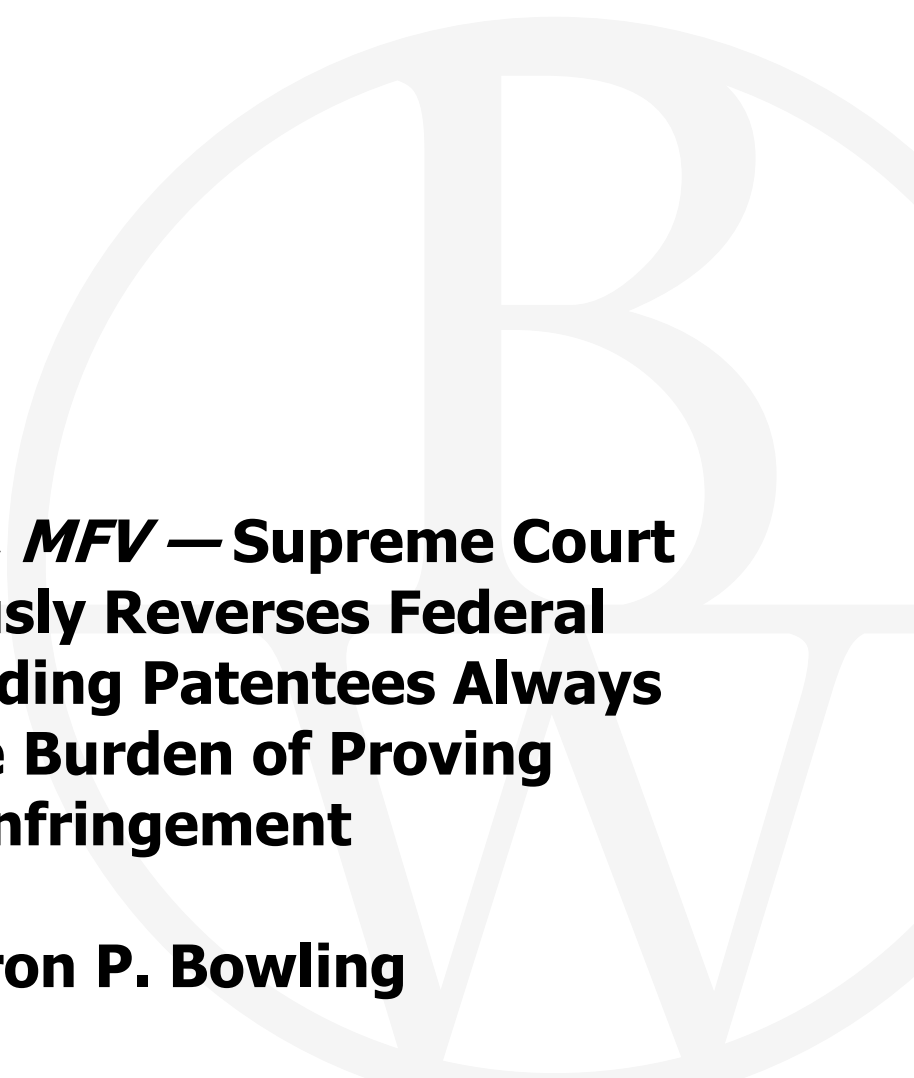

***Medtronic v. MFV* — Supreme Court  
Unanimously Reverses Federal  
Circuit: Holding Patentees Always  
Bear the Burden of Proving  
Infringement**

**Aaron P. Bowling**

***Banner & Witcoff Intellectual  
Property Alert***

**January 23, 2014**



## Intellectual Property Alert:

### *Medtronic v. MFV* — Supreme Court Unanimously Reverses Federal Circuit: Holding Patentees *Always* Bear the Burden of Proving Infringement

By [Aaron P. Bowling](#)

Jan. 23, 2014 — On Tuesday, the Supreme Court unanimously reversed the Federal Circuit in *Medtronic v. Mirowski Family Ventures* (previously listed as *Medtronic v. Boston Scientific*), holding that the burden of proving infringement remains on the patent owner, even when a licensee seeks a declaratory judgment of noninfringement. The decision, authored by Justice Stephen Breyer, appears to substantially benefit patent licensees, who, upon showing declaratory standing, may now force the licensor to prove that a licensed patent covers the licensee's products, and do so at a time and forum of the licensee's choosing.

#### **Background and Procedural Posture**

In 1991, Medtronic, a designer, manufacturer and distributor of medical devices, entered into a licensing agreement with Mirowski Family Ventures (MFV), the owner of various patents relating to implantable heart stimulators. Under the most recent version of that agreement, when Medtronic developed a new product, MFV could allege “infringement” of the licensed patents, Medtronic could then take one of three courses of action: (a) concede coverage of MFV's patent over the new product and pay additional royalties; (b) pursue a declaratory judgment of no infringement, meanwhile accumulating royalties in escrow; or (c) ignore the agreement entirely, and allow MFV to terminate the license and bring an infringement action. Sure enough, in 2007, Medtronic and MFV found themselves in disagreement over whether the licensed patents covered several newly developed products. Medtronic filed a declaratory action in federal court seeking a ruling of noninfringement and invalidity.

At trial, the district court followed the general rule that patent owners carry the burden of proving infringement. A jury found for Medtronic, concluding that MFV had failed to show infringement of the patents-in-question. On appeal, however, the Federal Circuit carved out a narrow exception to the general rule, holding that Medtronic, the licensee and declaratory plaintiff, carried the burden to show noninfringement. It reasoned that the patent owner was a declaratory defendant, foreclosed from asserting an infringement claim because of the existing licensing agreement.

#### **Supreme Court's Reversal — Patentee *Always* Carries the Burden of Proving Infringement**

As expected from the tone of oral arguments, the Supreme Court reversed the Federal Circuit on both statutory and policy grounds, ultimately holding that:

*“[When] a patent licensee paying royalties into an escrow account under a patent licensing agreement seeks a declaratory judgment that some of its products are not covered by or do not infringe the patent . . . the burden of persuasion is with the patentee, just as it would be had the patentee brought an infringement action.”*

Beginning with the Declaratory Judgment Act, the high court used three steps of “simple legal logic, resting upon settled case law” to dismantle the Federal Circuit’s burden shift. It stated that: (1) the burden of proving infringement typically rests on the patentee; (2) the Declaratory Judgment Act has only procedural, not substantive, impact; and (3) the burden of proof is a substantive aspect of a claim. Therefore, the Court held, the Federal Circuit had no legal justification for shifting the burden of proof as a result of the declaratory nature of the suit.

The Court noted further practical and policy-based concerns with the Federal Circuit’s rule that shifted the burden of proof to the licensee. Under that rule, the licensee faces the difficult task of proving a negative; an especially difficult task because, unlike the patentee who best understands the complex patent and its limitations, the licensee is “work[ing] in the dark, seeking. . . to negate every conceivable infringement theory.” Accordingly, because “licensees may often be the only individuals with enough economic incentive to litigate questions of a patent’s scope,” the Court opined that keeping the burden of proof on the patentee in these circumstances helps ensure that “patent monopolies are kept within their legitimate scope.”

Furthermore, the Court explained that the Federal Circuit rule would cause post-litigation uncertainty amongst the public, and the parties, about the scope of the litigated patent. If the licensee failed to meet the difficult burden of proving noninfringement, the licensee (not yet found to be affirmatively infringing) could nonetheless continue its allegedly infringing activity until the patentee filed an infringement suit. In that later suit, with the burden of proving infringement back on the patentee, the earlier declaratory judgment action would have no claim preclusive effect and would fail to serve its intended purpose of providing “an immediate and definitive determination of the legal rights of the parties.” Instead, the parties would be forced to relitigate the entire infringement allegation, with the possibility that the patentee might too fail to meet its burden of proving infringement: leaving the ultimate infringement question in limbo.

Lastly, the Court was not swayed by MFV’s arguments that patent owners would be burdened by the ability of licensees “to force the patentee into full-blown patent infringement litigation. . . at [their] sole discretion.” Those circumstances, the Court countered, are limited to situations where the licensee can show a genuine dispute of “sufficient immediacy and reality” about the patent’s validity or its application. In that way, the “general public interest considerations are, at most, in balance. . . and do not favor a change in the ordinary rule imposing the burden of proving infringement upon the patentee.”

### **Subject Matter Jurisdiction**

The Court also briefly affirmed the presence of declaratory judgment jurisdiction, which is determined by looking at the declaratory defendant’s threatened action, i.e. whether the character of the defendant’s “hypothetical coercive action would necessarily present a federal question.”

Contrary to the assertions of an amicus that the only threatened action was one for breach of contract, the Supreme Court found that if Medtronic stopped paying royalties in accordance with its belief of noninfringement, MFV “*could* terminate the license and bring an ordinary federal patent law action for infringement,” and this potential patent infringement action was sufficient to show that “this declaratory judgment action, which avoids that threatened action, also “arises under” federal patent law.

### **Upcoming Patent Cases at the Supreme Court**

Notably, the Supreme Court has four additional patent cases scheduled for the remainder of this term: *Alice v. CLS Bank* (patent eligibility of software patents); *Limelight v. Akamai* (divided infringement, i.e., infringement by aggregated conduct of two or more actors); *Nautilus v. Biosig* (indefiniteness, i.e. vague claim language); and the twin cases *Highmark v. Allcare* and *Octane Fitness v. Icon Health* (attorney’s fees). Banner & Witcoff attorneys are following these cases and will provide IP Alerts on their arguments and decisions.



**Patent Case Attorneys' Fee Awards:  
The Supreme Court Characterizes  
Cases Argued Wednesday as "A  
Search for Adjectives;" Standards  
Likely to Change, Fees to be  
Awarded More Readily**

**Charles W. Shifley**

***Banner & Witcoff Intellectual  
Property Alert***

**February 27, 2014**



## Intellectual Property Alert: Patent Case Attorneys' Fee Awards: The Supreme Court Characterizes Cases Argued Wednesday As "A Search for Adjectives;" Standards Likely To Change, Fees to Be Awarded More Readily

By Charles W. Shifley

Feb. 27, 2014 – The U.S. Supreme Court heard oral argument yesterday in its two cases on attorneys' fees awards in patent infringement cases. The issues in *Octane Fitness v. Icon Health & Fitness* and *Highmark v. Allcare Health Management Systems* are the standards for the district courts and the courts of appeals to use in deciding whether there are to be such awards.

In *Octane*, the petitioner, an accused infringer who defeated a patent claim and was denied an award of fees at the district court, sought to lower the standard for awards and gain another chance for an award. In *Highmark*, the petitioner was also an accused infringer who defeated a patent claim and was denied an award of fees, but in this case was denied only in part, by reversal of the fee award in part by the Federal Circuit. The petitioner sought to raise the standard for the courts of appeals to use in deciding whether district courts were correct in fee awards and gain reinstatement of the part of the fee award lost on appeal.

Reading the tea leaves of oral argument, the standard the district courts should use to decide whether to award fees will be whether the result of not shifting fees is a "serious injustice" or is "unusually unjust." It will not include a requirement of subjective bad faith. Also reading leaves, the standard the courts of appeals should use in reviewing fee awards will be deferential abuse of discretion. It will not be the lower and more full review de novo standard. The upshot may be success by both petitioners, more fee awards in district courts in future patent cases and less review of awards in the Federal Circuit.

### Arguments in *Octane*

The petitioner's argument in *Octane*, on standards for district courts, began that "frivolous and bad faith cases are not prerequisites." In an early question, Justice Kennedy characterized the issue as "a search for adjectives, in part." Chief Justice Roberts asserted the statutory standard of an "exceptional" case could mean one a hundred, or ten in a hundred. Justice Scalia pressed that "every time you win a summary judgment motion, that's a determination that the claim is meritless," so what should be added to set a standard, to the petitioner's word and standard for cases getting fee awards, i.e., the word and standard of "meritless" cases?

Mr. Teschler, for petitioner, responded that a claim that was "unreasonably weak" was exceptional and deserved a responsive award of fees. Countering questions about the differences between his position and Federal Circuit decision that a claim must be "objectiveless baseless," he argued that the Federal Circuit test required zero merit, or frivolousness, and resulted in too few awards.

Justice Alito pressed further, asking how a district judge hearing few patent cases would have any cases for comparison, to conclude a case was exceptional. Chief Justice Roberts returned, getting affirmation that a test of gross injustice would be proper, and then expressing that a test of gross injustice would result in fee awards in a portion of cases that was tiny, lower than a test of meritlessness.

The United States next argued. It asserted that baselessness and bad faith did not both have to be present for fees, that an objectively unreasonable argument could trigger fees even if not frivolous, and clear and convincing evidence is not required. Chief Justice Roberts asked why “gross injustice” was the government test, and Justice Breyer contributed that the source of the term was the Senate report on the law’s bill. After discussion, Justice Scalia asked why the government-proposed standard was not “exceptional injustice.”

Respondent, the potential loser of fees on a reversal, argued early that awarding fees was a First Amendment concern, because patent owners should have free access to the courts. Chief Justice Roberts quipped, “what, to bring a patent case?” Asked whether Congress could not provide a “loser pays” system, Mr. Phillips conceded it could, and Justice Scalia stated he could not perceive it to be unconstitutional to adopt a loser pays system. To a response of laughter, Justice Kennedy told counsel the First Amendment was not his best argument. Justice Breyer soon posed the problem of non-practicing entities who sue defendants in quantities, seeking numerous small settlements. He questioned why an accused who won against the NPE claim, at a multi-million dollar cost, should not get fees, even where the claim was not objectively baseless, but was “barely over the line,” and in his words, a “serious injustice,” or in another phrasing “unusually unjust,” “no” [requirement of] clear and convincing [evidence].” Justice Ginsburg asserted that the Lanham Act had the same “exceptional” language, required only a case “not run of the mine,” and was compelling for an identical interpretation. Justice Scalia also asserted that patent owners’ lawyers might give different advice to their clients about bringing suits with a different standard for fees, because the current standard was one of “nothing to lose.”

### **Arguments in *Highmark***

In *Highmark*, where the issue is the standard of review of fee awards by courts of appeals, the bench was more quiet. Petitioner’s argument began by saying that a district court’s award of fees should not be reviewed in a court of appeals without deference to the district court. Justice Kagan questioned that given that claim interpretation is an issue of law, why is the reasonableness of a litigant’s claim construction not also an issue of law?

Mr. Katyal, for petitioner, responded with a case, *Pierce*, in which the Supreme Court set a standard of abuse of discretion for review of attorneys’ fees in a different area of law. Justice Ginsburg questioned why an abuse of discretion standard would not result in different results in similar cases by different district courts. Counsel again responded with a case, one in criminal law in which the Supreme Court allowed disparities.

Next came a question how a reversal in *Octane* might affect *Highmark*, by Justice Sotomayor. Counsel expressed that his case would get stronger, if any test of objective baselessness remained. He concluded with a point that in the *Pierce* case, the Supreme Court stated that retrospective collateral questions, such as how reasonable an argument was, should not receive court of appeals resources.

The federal government argued for an abuse of discretion standard of review.

For respondent, Mr. Dunner began to argue that case law favored his client. Justice Sotomayor responded with his facts, that the district court found abusive litigation in too little pre-filing investigation, switching of assertions due to the too little investigation, and pursuing a theory with disagreement by the patent owner's own expert. Counsel replied with an explanation that the facts as stated were incorrect. Arguing further, counsel asserted that the Federal Circuit deserved breadth to its appellate review to bring about uniformity, as was its purpose.

Chief Justice Roberts shot back that the Federal Circuit judges had a great deal of disagreement among themselves and were "going back and forth" among themselves in the area of attorneys' fee awards. Pinned, counsel admitted disagreement, but returned to the view that while imperfect, the Federal Circuit was the best tribunal as it gets "tons of patent cases." Chief Justice Roberts again countered, asserting that district courts actually have more experience with the reasonableness of litigation positions and are more expert than the Federal Circuit. Counsel asserted that in reasonableness in a patent context, the district courts are not better situated than the Federal Circuit. He also asserted that a fee award was typically reviewed in the same appeal with the underlying case decisions of infringement and validity, and fee award review did not place an enormous burden on the court of appeals.

Having heard the argument, Justice Scalia next questioned with the point that the attorneys' fees statute "quite clearly doesn't" envision uniformity of decision. Listening further, Justice Breyer expressed that the heart of the issue was to say to the court of appeal, "start distinguishing between which of two categories" of decision, fact and law, were under review, which would lead to work to distinguish issues, while leaving discretion in the district courts was simpler. Justice Sotomayor returned to the specific facts of the case, saying the matter of fees was not about "right or wrong and legal answer; it's about behavior during litigation."

### **Standards Could Change**

Overall, the impressions left by the arguments are impressions for change. For the *Octane* petitioner, change will mean a looser, more discretionary standard in the district courts than currently allowed by the Federal Circuit. For the *Highmark* petitioner, change will mean a tighter, less discretionary standard of review by awards in the Federal Circuit. In short, awards may go up in number, and survive more easily on appeal.

To subscribe or unsubscribe to this Intellectual Property Advisory,  
please send a message to Chris Hummel at [chummel@bannerwitcoff.com](mailto:chummel@bannerwitcoff.com)



[www.bannerwitcoff.com](http://www.bannerwitcoff.com)

© Copyright 2014 Banner & Witcoff, Ltd. All Rights Reserved. The opinions expressed in this publication are for the purpose of fostering productive discussions of legal issues and do not constitute the rendering of legal counseling or other professional services. No attorney-client relationship is created, nor is there any offer to provide legal services, by the publication and distribution of this edition of IP Alert.





***Octane Fitness v. Icon and Highmark  
v. Allcare* — Pivotal Changes to  
Court Awarded Attorneys' Fees in  
Patent Litigations**

**Aaron P. Bowling**

***Banner & Witcoff Intellectual  
Property Alert***

**April 30, 2014**



## Intellectual Property Alert:

### *Octane Fitness v. Icon* and *Highmark v. Allcare* — Pivotal Changes to Court Awarded Attorney’s Fees in Patent Litigations

By [Aaron P. Bowling](#)

April 30, 2014 – On Tuesday, in two unanimous decisions, the Supreme Court laid down a pair of pivotal changes to the rules governing court awarded attorney’s fees in patent litigations. The two cases, *Octane Fitness v. Icon* and *Highmark v. Allcare*, centered on 35 U.S.C. § 285, which provides that district courts “in exceptional cases may award reasonable attorney’s fees to the prevailing party.”

Together, Tuesday’s decisions provide district courts with significantly more discretion in awarding attorney’s fees to successful patent litigants and also considerably limit the ability of appellate courts to overturn those awards. As a likely result, motions for attorney fee awards will be more frequently filed, granted, and upheld; and defendants facing baseless lawsuits from non-practicing entities and others will have an additional arrow in their quiver.

#### **35 U.S.C. § 285 and the Federal Circuit’s *Brooks Furniture* Standard**

The Supreme Court has long held that district courts determining the award of attorney fees should undergo a holistic, equitable analysis that accounts for the totality of circumstances. The “exceptional cases” language in § 285, the Court has emphasized, should not be interpreted as negating the discretionary nature of the district court’s analysis. In 2005, however, the Federal Circuit in *Brooks Furniture* set forth a rule that limited “exceptional” cases to two categories of extreme circumstances.

First, under *Brooks Furniture*, a case could be deemed “exceptional” when a party engaged in “material inappropriate conduct,” *i.e.* “willful infringement, fraud or inequitable conduct in procuring the patent, misconduct during litigation, vexatious or unjustified litigation, conduct that violates Fed. R. Civ. P. 11, or like infractions.” Second, absent any such material misconduct, attorney’s fees could be imposed against the patentee only if *both* (1) the litigation was brought in subjective bad faith (“so unreasonable that no reasonable litigant could believe it would succeed”), and (2) the litigation was objectively baseless (the plaintiff “actually knows that it is objectively baseless”).

#### ***Octane v. Icon Health & Fitness***

In *Octane*, patentee Icon Health & Fitness sued Octane for infringement of Icon’s U.S. Patent No. 6,019,710. The district court granted Octane’s motion for summary judgment of non-infringement but, under *Brooks Furniture*, denied Octane’s motion for

attorney's fees under § 285. The district court found Icon's claims neither objectively baseless nor brought in bad faith. After the Federal Circuit affirmed and declined to "revisit the settled standard for exceptionality," the Supreme Court granted certiorari and heard oral arguments in February.

In a concise, textually-based opinion authored by Justice Sotomayor, the Supreme Court cited the plain language of "exceptional" to unanimously strike down the Federal Circuit's "rigid formulation." The *Brooks Furniture* test, the Justices opined, "superimposed an inflexible framework onto statutory text that is inherently flexible." The high court found both prongs of the Federal Circuit's test problematic: the misconduct category as unnecessarily requiring independently sanctionable conduct, and the second category as improperly requiring *both* objectively baseless litigation *and* bad faith.

With respect to the former, the Court held that unreasonable activity not rising to the level of sanctionable conduct may nonetheless be sufficiently "exceptional" to render an award of attorney's fees appropriate. Similarly, with respect to the latter, the Court held that "a case presenting *either* subjective bad faith *or* exceptionally meritless claims may sufficiently set itself apart from mine-run cases to warrant a fee award."

In addition to finding the *Brooks Furniture* formulation "so demanding that it would appear to render § 285 largely superfluous," the Supreme Court also loosened the burden of proof placed on parties seeking attorney fee awards. In place of the *Brooks Furniture* "clear and convincing evidence" standard, the Court imposed a lesser "preponderance of the evidence" standard. "Section 285," the Court explained, "demands a simple discretionary inquiry; it imposes no specific evidentiary burden, much less a high one." Accordingly, the Court furthered, the preponderance of the evidence standard is appropriate because it "allows both parties to share in the risk of error in roughly equal fashion."

### ***Highmark v. Allcare Health Management***

In *Highmark*, the district court granted summary judgment of non-infringement in favor of alleged infringer Highmark and subsequently awarded attorney's fees in light of patentee Allcare's "vexatious" and "deceitful" conduct. On appeal, the Federal Circuit reversed the district court's "exceptional case" determination as to one claim using a three-tiered standard of review. The Federal Circuit applied *de novo* review to the "objectively baseless" prong, applied a clearly erroneous standard to the "subjective bad-faith" prong, and held that if the case is deemed "exceptional," the resultant award of fees should be reviewed for an abuse of discretion.

On Tuesday, the Supreme Court issued a brief five-page opinion holding that "an appellate court should apply an abuse of discretion standard in reviewing *all* aspects of a district court's § 285 determination." Citing its concurrently-issued *Octane* opinion, the Court noted that "[b]ecause § 285 commits the determination of whether a case is

‘exceptional’ to the discretion of the district court, that decision is to be reviewed on appeal for an abuse of discretion.”

In sum, under *Octane* and *Highmark*, a case may now be “exceptional” if it simply “stands out from others with respect to the substantive strength of the party’s litigating position (considering both the governing law and the facts of the case) or the unreasonable manner in which the case was litigated.” District courts may determine whether a case is exceptional by a preponderance of the evidence in the case-by-case exercise of their discretion, considering the totality of the circumstances; and appellate courts may overturn those awards only for an abuse of discretion.

To subscribe or unsubscribe to this Intellectual Property Advisory, please send a message to Chris Hummel at [chummel@bannerwitcoff.com](mailto:chummel@bannerwitcoff.com)



[www.bannerwitcoff.com](http://www.bannerwitcoff.com)

© Copyright 2014 Banner & Witcoff, Ltd. All Rights Reserved. The opinions expressed in this publication are for the purpose of fostering productive discussions of legal issues and do not constitute the rendering of legal counseling or other professional services. No attorney-client relationship is created, nor is there any offer to provide legal services, by the publication and distribution of this edition of IP Alert.



**Supreme Court Hears Arguments  
Regarding Induced Infringement  
In *Limelight***

**H. Wayne Porter**

***Banner & Witcoff Intellectual  
Property Alert***

**May 1, 2014**



## Intellectual Property Alert:

Supreme Court Hears Arguments Regarding Induced Infringement in *Limelight*

by [H. Wayne Porter](#)

On April 30, 2014, the U.S. Supreme Court heard arguments in *Limelight Networks, Inc. v. Akamai Technologies, Inc.* The issue in this case is whether there can be liability for induced infringement if no party is liable for direct infringement. Akamai's claimed method involved placing web content on a set of replicated servers and modifying a content provider's web page to instruct browsers to retrieve content from those servers. Akamai sued Limelight alleging direct and indirect infringement. Limelight maintained a network of servers, but Limelight did not itself modify the content providers' web pages. In effect, Limelight's customers performed one of the claim steps and Limelight performed other steps. Akamai proceeded to trial on direct infringement only. The trial judge ultimately granted judgment as a matter of law because the claim steps were performed by multiple parties and because Limelight did not direct and control the actions of the content providers.

In an en banc decision, the Court of Appeals for the Federal Circuit Court declined to revisit the law of "divided infringement" as it pertains to liability for direct infringement under 35 U.S.C. § 271(a). As a result, the Federal Circuit upheld Limelight's non-liability for direct infringement under § 271(a). Under the law which the Federal Circuit did not revisit, there is no liability under § 271(a) for direct infringement of a method claim when an accused infringer performs some claim steps and another party performs the other steps unless that other party is the agent of the accused infringer or acting under the accused infringer's direction or control. However, the Federal Circuit further held that Limelight could be liable under 35 U.S.C. § 271(b) for induced infringement. This was a significant change in the law. Previously, a patentee relying on § 271(b) had to show that an accused party actively induced a single entity (or a single entity and one or more agents or other directed or controlled parties) to perform all of the method steps.

Limelight and Akamai both filed petitions for certiorari. The Supreme Court granted Limelight's petition, but Akamai's petition remains pending. Briefs were filed and oral arguments were heard on April 30, 2014, in connection with Limelight's petition. The following was presented as the question on appeal: "whether the Federal Circuit erred in holding that a defendant may be liable for inducing patent infringement under 35 U.S.C. § 271(b) even though no one has committed direct infringement under § 271(a)." In its brief, Akamai argued that Limelight's liability under § 271(a) was also fairly included in the question presented and urged the Court to address § 271(a) liability. Limelight disputed that § 271(a) liability was properly before the Court.

During the oral arguments, at least some members of the Court seemed concerned that the issues may go beyond the Federal Circuit's extension of § 271(b) liability.

On one hand, at least some of the justices seemed to have trouble with the Federal Circuit decision. Justices Scalia and Kagan both made comments suggesting concern over whether the Federal Circuit's decision is contrary to the language of § 271(b). Justice Breyer expressed discomfort with changing patent law that had been in place for a number years.

On the other hand, some of the Justices' comments suggested that the issues run deeper. For example, Chief Justice Roberts suggested that Limelight's position makes it easy to avoid patent infringement, commenting that "[a]ll you've got to do is find one step in the process and essentially outsource it . . . or make it attractive for someone else to perform." After Limelight's counsel argued that such problems could be addressed through claim drafting, Justice Scalia expressed skepticism. In the same comment where she noted the strength of an argument against the Federal Circuit's extension of liability under § 271(b), Justice Kagan also pointed out that the decision was an attempt to avoid what the Federal Circuit thought to be an end-run around the patent laws. Justice Kagan asked whether a decision reversing the Federal Circuit's decision regarding § 271(b) would have relevance if the Federal Circuit is then able to revisit the standard for liability under § 271(a). Justice Alito repeatedly asked whether there is any policy reason supporting a finding of non-infringement on the facts of Limelight's case, and also questioned whether a decision by the Court regarding § 271(b) has any significance unless the Federal Circuit is right about § 271(a).

Ultimately, resolution of this case may depend on whether the Court addresses § 271(a). If the Court believes that § 271(a) must be addressed, the Court may grant Akamai's petition, receive further briefing and hear additional argument next term before deciding. Counsel for Akamai suggested this as a possible approach. Although that approach might be somewhat unusual procedurally, several Justices expressed concern with addressing § 271(a) on the current briefing. If the Court does not address § 271(a), however, the Court may be willing to simply reverse or affirm the Federal Circuit decision expanding liability under § 271(b), and to further indicate that it is the responsibility of Congress to fix any perceived problems or gaps in the law.

To subscribe or unsubscribe to this Intellectual Property Advisory, please send a message to Chris Hummel at [chummel@bannerwitcoff.com](mailto:chummel@bannerwitcoff.com)



[www.bannerwitcoff.com](http://www.bannerwitcoff.com)

© Copyright 2014 Banner & Witcoff, Ltd. All Rights Reserved. The opinions expressed in this publication are for the purpose of fostering productive discussions of legal issues and do not constitute the rendering of legal counseling or other professional services. No attorney-client relationship is created, nor is there any offer to provide legal services, by the publication and distribution of this edition of IP Alert.



**U.S. Supreme Court Says Induced  
Infringement Requires Direct  
Infringement, But Leaves Direct  
Infringement Standard to Federal  
Circuit**

**H. Wayne Porter**

***Banner & Witcoff Intellectual  
Property Alert***

**June 3, 2014**





## Intellectual Property Alert:

### U.S. Supreme Court Says Induced Infringement Requires Direct Infringement, But Leaves Direct Infringement Standard to Federal Circuit

By H. Wayne Porter

June 3, 2014 — In a decision dated June 2, 2014, in the case *Limelight Networks, Inc. v. Akamai Technologies, Inc.* (No. 12-786), the U.S. Supreme Court held that a defendant is not liable for induced patent infringement under 35 U.S.C. § 271(b) if no one has directly infringed under 35 U.S.C. § 271(a) or any other statutory provision.

Normally, liability for direct infringement of a method claim requires that a single party perform all steps of that method. Under the Federal Circuit Court of Appeals decision in *Muniauction, Inc. v. Thomson Corp.*, 552 F.3d 1318 (2008), this requirement can be satisfied when steps are undertaken by multiple parties, but only if a single defendant exercises control or direction over the entire process such that every step is attributable to the controlling party. The patent claim in question, which relates to a method of delivering electronic data using a “content delivery network” (CDN), includes a step that requires “tagging” components to be stored on servers. Limelight operates a CDN and performs several steps of the patent claim. However, instead of tagging components of its customers’ websites for storage on Limelight’s servers, Limelight requires those customers to perform the tagging.

Akamai, an exclusive licensee of the patent at issue, won a jury verdict against Limelight for direct infringement under 35 U.S.C. § 271(a). After that verdict, *Muniauction* was decided. Relying on *Muniauction*, the trial court found that Limelight was not liable.

Akamai then appealed to the Federal Circuit. After vacating an initial panel decision that affirmed the trial court, the Federal Circuit considered the case en banc. In its ensuing decision, however, the Federal Circuit sidestepped the issue of direct infringement under 35 U.S.C. § 271(a). Instead of revisiting the *Muniauction* standard, the Federal Circuit found that Limelight could be liable under 35 U.S.C. § 271(b) for induced infringement, even though nobody would be liable for direct infringement.

Limelight and Akamai both filed petitions for certiorari to the Supreme Court, but the Court only granted Limelight’s petition. The Supreme Court reversed and remanded the case back to the Federal Circuit. Under the reasoning of the reversed Federal Circuit decision, and as explained by the Supreme Court, a defendant could be liable for inducing infringement under 35 U.S.C. § 271(b) if no one directly infringed under § 271(a) because direct infringement can exist independently of a § 271(a). The Supreme Court found that such an analysis fundamentally misunderstood method patent infringement and would deprive § 271(b) of ascertainable standards.

The Supreme Court decision in *Limelight* assumed that the *Muniauction* decision was correct. However, the Supreme Court was careful to note that it was not deciding the correctness of *Muniauction*. Declining Akamai's request to review the *Muniauction* standard for multi-actor direct infringement under § 271(a), the Supreme Court stated that "the Federal Circuit will have the opportunity to revisit the § 271(a) question if it so chooses." Whether the Federal Circuit will accept this invitation remains to be seen.

To subscribe or unsubscribe to this Intellectual Property Advisory,  
please send a message to Chris Hummel at [chummel@bannerwitcoff.com](mailto:chummel@bannerwitcoff.com)



[www.bannerwitcoff.com](http://www.bannerwitcoff.com)

© Copyright 2014 Banner & Witcoff, Ltd. All Rights Reserved. The opinions expressed in this publication are for the purpose of fostering productive discussions of legal issues and do not constitute the rendering of legal counseling or other professional services. No attorney-client relationship is created, nor is there any offer to provide legal services, by the publication and distribution of this edition of IP Alert.



**District Court Reviews Will Permit  
New Evidence**

**Ernest V. Linek**

***Intellectual Property Magazine***

**September 1, 2014**

# District court reviews will permit new evidence

## THE CASE

*Stephen P Troy, JR v Samson Manufacturing Corp*  
US Court of Appeals for the Federal Circuit  
11 July 2014

The decision to allow new evidence in a recent Federal Circuit appeal case will be welcomed by IP lawyers preparing challenges to the patent appeals board, says **Ernest V Linek**

**On 11 July 2014, the US Court of Appeals for the Federal Circuit decided the case of *Stephen P Troy, JR v Samson Manufacturing Corp*, an appeal from the US District Court for the District of Massachusetts.**

Intellectual property attorneys who challenge decisions from the US Patent and Trademark Office's Board of Patent Appeals and Interferences (Board) will applaud this decision as it permits new evidence to be presented during a district court review of an adverse Board decision.

The Massachusetts district court case was a civil action filed by Stephen P Troy under 35 USC § 146, for review of an adverse decision issued by the Board. The Board, in an interference proceeding with Samson Manufacturing Corp, had cancelled the claims of Troy's US Patent No. 7,216,451 ('451 patent).

In an interference case, the party showing that it was first to invent the subject matter usually has priority, and with priority comes the right to patent protection on the subject matter of the patent. Such cases are slowly disappearing – as the new America Invents Act no longer permits interferences. Now the first inventor to file has priority against later filers for the same invention.

The Board declared an interference between Troy's '451 patent and Samson's US Patent Application No 11/326,665 ('665 application). Because Samson's '665 application had an earlier priority date than the '451 patent, Samson was named the senior party – which includes a presumption of priority.

The Board concluded that Troy failed to prove that he should have priority and entered judgment against Troy, and ordered all claims of the '451 patent cancelled.

Troy challenged the Board's decision in the Massachusetts district court under § 146, and proffered new evidence to support his priority claim. After reviewing the record before the Board and some of the new evidence proffered

by Troy, the district court concluded that Troy failed to carry his burden to prove priority. The district court then affirmed the Board's order canceling all claims of Troy's patent.

More importantly, the district court refused to consider some of the new evidence offered by Troy, because "[a] party is generally precluded from raising issues or theories of law in a Section 146 proceeding that were not previously raised before the board."

**"The court could find no basis in the language of the statutes for differing treatment with regard to the types of evidence that ought to be admitted."**

Troy's Federal Circuit appeal challenged the district court's refusal to consider evidence pertaining to issues not raised before the Board. Troy argued that the US Supreme Court rejected the rule against new issues when it held that "there are no limitations on a patent applicant's ability to introduce new evidence in a § 145 proceeding beyond those already present in the Federal Rules of Evidence and the Federal Rules of Civil Procedure," see *Kappos v Hyatt*, 132 S Ct 1690, 1700–01 (2012).

Samson argued that even if *Hyatt* requires that the district court admit such new evidence, the holding in that case is applicable to § 145 actions only. Samson argued that the proceeding at issue in this case, an interference arising under § 146, ought not to be governed by the same rules. Troy responded that there is no meaningful difference between § 145 and § 146, and that both types of proceedings ought to be subject to the same evidentiary rules.

The Federal Circuit concluded that to

the extent that prior precedent see, eg, *Conservolite v Widmayer*, 21 F.3d 1098, 1102 (Fed Cir 1994), held that new evidence on an issue not presented to the Board was generally to be excluded in district court proceedings, is no longer viable following the Supreme Court's *Hyatt* decision.

The question confronted by the Federal Circuit was whether there are differences between § 145 and § 146 such that the evidentiary rules that apply to § 145 actions ought not to similarly apply to § 146 actions. The court could find no basis in the language of the statutes for differing treatment with regard to the types of evidence that ought to be admitted. The court thus concluded that the Supreme Court's decision in *Hyatt* applies with equal force to both § 145 and § 146 actions.

The Federal Circuit reversed the ruling from the district court, holding that new evidence is to be admitted without regard to whether the issue was raised before the Board. The case was vacated and remanded because the district court erred in refusing to consider new evidence pertinent to a critical issue in the patent interference, namely the determination of priority.

## Author



Ernest V Linek is a principal shareholder in the Boston office of Banner & Witcoff. He has successfully prosecuted hundreds of US and international patent applications, and assisted clients in the selection and registration of hundreds of new trademarks and service marks in the US and abroad. He has also successfully protected clients' interests in numerous federal district courts and before the US Court of Appeals for the Federal Circuit.



**Patent Developments for IT  
Practitioners**

**Bradley C. Wright**

**Presented to the *Virginia  
Information Technology Legal  
Institute***

**October 10, 2014**

# **PATENT DEVELOPMENTS FOR IT PRACTITIONERS**

**(Sept. 2013 to Sept. 2014)**

**PRESENTED AT:**

**THE VIRGINIA INFORMATION TECHNOLOGY  
LEGAL INSTITUTE**

**FAIRFAX, VA  
OCTOBER 10, 2014**

**BRADLEY C. WRIGHT  
BANNER & WITCOFF, LTD  
1100 13<sup>TH</sup> STREET, N.W.  
WASHINGTON, D.C. 20005  
(202)-824-3160  
[bwright@bannerwitcoff.com](mailto:bwright@bannerwitcoff.com)  
[www.bannerwitcoff.com](http://www.bannerwitcoff.com)**



**BANNER & WITCOFF, LTD.  
INTELLECTUAL PROPERTY LAW**

## OUTLINE OF WRITTEN MATERIALS

- A. Patentability, Validity, and Procurement of Patents
  - 1. Statutory Subject Matter – Computer Software and Genes
  - 2. Uncorrected Patent Claim is Unenforceable Until Corrected
  - 3. Indefiniteness of Patent Claims
  - 4. Reissue Application Cannot be Used to Modify Terminal Disclaimer
  - 5. Written Description
  - 6. Reexamination Results Trump Litigation Validity
  - Determination 7. Ability to Force or Stop Inter Partes Review at the PTO
  
- B. Interpretation and Infringement of Patents
  - 1. Claim Construction
  - 2. Disclaimer of Claim Scope
  - 3. Induced Infringement Requires Evidence of Direct
  - Infringement 4. Prosecution History Estoppel Applies to Design Patents
  
- C. Enforcement of Patents
  - 1. Standards-Essential Patents
  - 2. Injunctions
  - 3. Attorney's Fees
  - 4. Induced Infringement at the ITC
  - 5. Infringement Damages
  - 6. Patent Co-Owner Can Preclude Infringement Suit
  - 7. Stays of Litigation Pending PTO Review of Patent
  - 8. Consumer Groups May Lack Standing to Attack Patents
  - 9. Contempt Order Not Appealable Until Sanctions Determined
  - 10. Declaratory Judgment Jurisdiction Where Customers are Sued
  - 11. Inequitable Conduct
  - 12. Patent Exhaustion
  - 13. Induced Infringement – Believe in Invalidity as a Defense
  - 14. Burden of Proving Infringement in a DJ Action
  - 15. Patent Trolls – New Proposed Legislation, Litigation Strategies & More

## A. Patentability, Validity, and Procurement of Patents

### 1. Statutory Subject Matter – Computer Software and Genes

*Alice Corp. Pty Ltd v. CLS Bank Int'l*, 134 S.Ct. 2347 (2014), *affirming* 717 F.3d 1269 (Fed. Cir. 2013). Alice Corp. is the owner of four patents that cover a computerized trading platform for exchanging obligations in which a trusted third party settles obligations between a first and second party to eliminate settlement risk, which is the risk that only one party's obligation will be paid. Three types of patent claims were at issue: (1) method claims; (2) computer-readable media claims; and (3) system claims. The district court held that all the claims were not patent-eligible under 35 U.S.C. § 101 because they fell within the "abstract ideas" exception to patentability. A panel of the Federal Circuit initially reversed, holding that the claims were directed to practical applications of the invention falling within the categories of patent eligible subject matter. The panel stated that it must be "manifestly evident that a claim is directed to a patent ineligible abstract idea" before it will be ruled invalid. The Federal Circuit later granted a petition for rehearing en banc.

The *en banc* court (decided by 10 judges who were eligible to hear the case) reversed the panel decision and issued a total of 6 separate opinions, plus a seventh "additional views" passage by Chief Judge Rader. In a per curiam opinion, a majority of the judges agreed that the method and computer-readable media claims were invalid, but disagreed as to the reasoning. An equally divided (5-member) court affirmed the district court's decision that the system claims were also invalid. Judge Lourie (joined by 4 others) concluded that all claims were invalid because they "preempt a fundamental concept" – the "idea" of the invention is third-party mediation, and clever claim drafting cannot overcome that preemption. Judge Rader, writing for a 4-member minority, agreed that the method and computer-readable media claims were invalid because they recited an abstract concept, but would have upheld the patentability of the system claims, pointing out that a machine cannot be an "abstract idea." Judge Moore, writing for 4 judges, also pointed out that the system claims should not be considered an abstract idea. Judge Newman would have found all of the claims patent-eligible. Judges Linn and O'Malley would also have found all claims to be patent-eligible because the parties agreed that all claims required the use of a computer. Judge Rader's "additional views" lamented the lack of agreement on the issue.

The U.S. Supreme Court affirmed, concluding that all of the claims were not eligible for a patent. The Court began by reviewing the "framework" it established in *Mayo Collaborative Services v. Prometheus Laboratories*, 132 S.Ct 1289 (2012) for distinguishing patents that claim abstract ideas from those that claim patent-eligible subject matter. First, the Court determines whether the claims at issue are directed to one of those patent-ineligible concepts. If the claims are directed to a patent-ineligible concept, the Court then asks what else in the claims constitutes an



“inventive concept” – i.e., an elements or combination of elements that is “sufficient to ensure that the patent in practice amounts to significantly more than a patent upon the [ineligible concept] itself.”

In this case, the Court determined that the claims were drawn to the abstract idea of intermediated settlement. Analogizing the claims in this case to those at issue in *Bilski v. Kappos*, 561 U.S. 593 (2010), which involved a series of steps for hedging risk, the Court concluded that the claims here were directed to a method of exchanging financial obligations between two parties using a third-party intermediary to mitigate settlement risk. “On their face, the claims before us are drawn to the concept of intermediated settlement, i.e., the use of a third party to mitigate settlement risk.” The Court concluded that the use of a third-party intermediary “is also a building block of the modern economy.” (citing treatises).

Applying the second step of the *Mayo* analysis, the Court examined the claims to determine whether they contained any “inventive concept” sufficient to “transform” the claimed abstract idea into a patent-eligible application. The Court explained that the claim must be more than a “drafting effort designed to monopolize the abstract idea.” The Court also noted that “the introduction of a computer into the claims does not alter the analysis at *Mayo* step two.” Citing its earlier decisions in *Benson* and *Flook*, the Court explained that limiting the use of the idea to a particular technological environment could not circumvent the prohibition on abstract ideas. “The mere recitation of a generic computer cannot transform a patent-ineligible abstract idea into a patent-eligible invention.” As to the specific system claims that recited specific hardware elements, the Court concluded that a “data processing system,” a “communications controller,” and a “data storage unit,” were “purely functional and generic.” According to the Court, “nearly every computer will include a ‘communications controller’ and ‘data storage unit.’ As a result, none of the hardware recited by the system claims offered a “meaningful limitation” beyond generally linking the use of the method to a particular technological environment.

The Court seemingly distinguished inventions that “improve the functioning of the computer itself” and inventions that “effect an improvement in any other technology or technical field” from the holding of this case. These two factors might very well be the new “safe harbors” in claiming inventions that can otherwise be characterized as an “abstract idea.”

*In re Roslin Institute*, 750 F.3d 1333 (Fed. Cir. 2014). The Federal Circuit affirmed the U.S. PTO’s determination that claims directed to a cloned animal – “Dolly the Sheep” – were unpatentable subject matter. Relying on the recent U.S. Supreme Court’s decision in *Association for Molecular Pathology v. Myriad Genetics*, 133 S.Ct. 2107 (2013), which held that naturally-occurring organisms such as isolated genes are not patentable, the court explained that “Dolly herself is an exact genetic replica of another sheep and does not possess ‘markedly different characteristics from any [farm animals] found in nature.’” According to the court, “Dolly’s genetic identity to her donor parent renders her unpatentable.”

*Digitech Image Tech., LLC v. Electronics for Imaging, Inc.* 758 F.3d 1344 (Fed. Cir. 2014). Digitech, which owns U.S. Patent No. 6,128,415 directed to a “device profile” and a method for creating a device profile in a digital image processing system, sued 32 defendants for patent infringement. The district court granted summary judgment of invalidity of the patent in favor of the defendants, and Digitech appealed.

The structure of the claims was as follows:

1. A *device profile* for describing properties of a device in a digital image reproduction system . . . comprising:

*first data* for describing a device dependent transformation of color information content of the image . . . and

*second data* for describing a device dependent transformation of spatial information content of the image . . . .

10. A method of generating a device profile that describes properties of a device in a digital image reproduction system . . . comprising:

*generating first data* for describing a device dependent transformation of color information content of the image . . .

*generating second data* for describing a device dependent transformation of spatial information content of the image . . . and

*combining* said first and second data into the device profile.

The district court ruled that the “device profile” claims were directed merely to a collection of numerical data lacking any physical component or physical manifestation, and thus it did not fall within one of the four statutory categories of patent-eligible subject matter under 35 U.S.C. § 101. The court also ruled that the method claims were invalid because they were directed to the abstract idea of organizing data through mathematical correlations.

The Federal Circuit affirmed. As to the “device profile” claims, the Federal Circuit explained that “For all categories except process claims, the eligible subject matter must exist in some physical or tangible form” and that to qualify as a machine, the claimed invention must be “a concrete thing, consisting of parts, or of certain devices and combination of devices” (quoting *Burr v. Duryee*, 68 U.S. 531 (1863)). Because the “device profile” claims did not include anything tangible, they were not eligible for patent protection and thus the claims were invalid.

As to the method claims, the Federal Circuit cited the Supreme Court’s recent

decision in *Alice Corp. v. CLS Bank Int'l*, 134 S.Ct. 2347 (2014) (see above) for the proposition that the claims merely recited an abstract idea because they describe a process for organizing information through mathematical correlations and are not tied to a specific structure or machine. According to the court, “The above claim recites a process of taking two data sets and combining them into a single data set, the device profile.” Quoting from the Supreme Court’s 1972 decision in *Parker v. Flook*, the Federal Circuit concluded that “If a claim is directed essentially to a method of calculating, using a mathematical formula, even if the solution is for a specific purpose, the claimed method is nonstatutory.”

*Buysafe, Inc. v. Google, Inc.*, \_\_\_ F.3d \_\_\_, 2014 WL 4337771 (Fed. Cir. Sept. 3, 2014). The Federal Circuit affirmed a district court’s ruling on a motion to dismiss on the pleadings a patent directed to a method and machine-readable medium for guaranteeing a party’s performance of its online transaction. Relying on *Alice*, the Federal Circuit first found that the claims “are squarely about creating a contractual relationship – a ‘transaction performance guaranty’ that is beyond question of ancient lineage.” It then concluded that the claims’ “invocation of computers adds no inventive concept. The computer functionality is generic – indeed, quite limited: a computer receives a request for a guarantee and transmits an offer of guarantee in return.”

Note: Since the Supreme Court’s *Alice* decision, there have been at least 11 district court decisions that have invalidated patents based on the *Alice* reasoning. Examples include *Loyalty Conversion Systems Corp. v. American Airlines*, No. 2:13-cv-655 (E.D. Tex. Sept. 3, 2014) (patents to loyalty reward program ruled unpatentable); *Walker Digital v. Google, Inc.*, No. 11-318 (D. Del. Sept. 3, 2014) (patents directed to employment search system ruled unpatentable); and *Tuxis Technologies, LLC v. Amazon.com, Inc.*, No. 13-1771 (D. Del. Sept. 3, 2014) (patent directed to method of “upselling” over electronic network declared invalid).

**Key Take-Away**: The PTO and courts are increasingly rejecting or invalidating patents directed to various types of inventions that can be characterized as an “abstract idea,” even if the claims recite specific computer components. Inventions in certain fields, such as financial services, electronic commerce, marketing/sales programs, loyalty programs, and others may be at higher risk of vulnerability.

## **2. Uncorrected Patent Claim Is Unenforceable Until Corrected**

*H-W Technology, L.C. v. Overstock.com, Inc.*, 758 F.3d 1329 (Fed. Cir. 2014). H-W Technology sued Overstock.com for infringing a patent relating to a device and method for performing contextual searches on an IP phone. The asserted method claim as approved by the patent examiner included a specific limitation relating to the user completing a transaction with a merchant without generating a voice call. As issued, however, the printed patent omitted this limitation. H-W had asserted the uncorrected patent in its lawsuit, and the district court concluded that the claim was invalid because it did not accurately reflect what was allowed by the patent

examiner. The Federal Circuit affirmed the district court’s refusal to judicially correct the patent, because the error was not “evident from the face of the patent.” Although the error was clear based on the prosecution history, that fact did not permit the court to correct the patent. The Federal Circuit also ruled that the district court properly refused to consider the later-filed certificate of correction, because of prior precedent concluding that such certificates are effective only for causes of action arising after the certificate was issued. Because H-W filed this lawsuit before the certificate of correction was issued, the patent was held to be unenforceable before its correction.

### 3. Indefiniteness of Patent Claims

*Nautilus, Inc. v. Biosig Instruments, Inc.*, 134 S.Ct. 2120 (2014). Biosig’s patent relates to a heart-rate monitor used with exercise equipment in a way that filters out electrical interference, allowing for more accurate measurements. The claim recites a cylindrical bar that a user grips with both hands, each hand contacting a pair of electrodes and a display device, wherein the pairs of electrodes are “mounted . . . in spaced relationship with each other:”

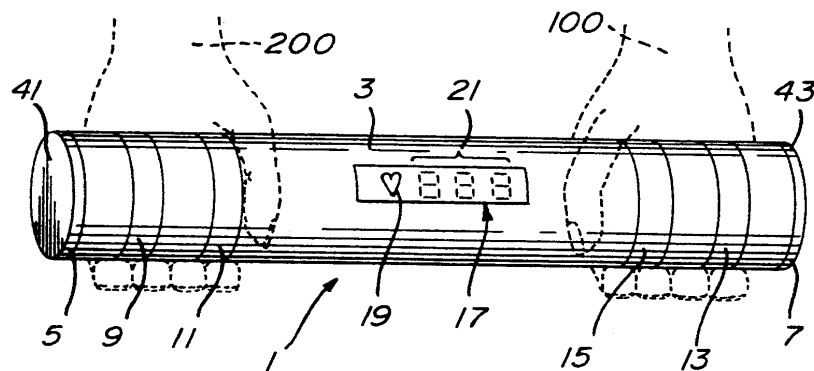

Biosig sued Nautilus for infringing the patent. While the suit was pending, Nautilus convinced the U.S. PTO to reexamine the patent based on prior art. During the reexamination proceedings, Biosig submitted a declaration by the inventor stating that the patent sufficiently informed a person skill in the art how to configure the electrodes so as to produce equal EMG signals from the left and right hands. Although the spacing of the electrodes could not be standardized across all types of exercise machines, the inventor explained that a person skilled in the art could use “trial and error” to determine the correct equalization. Thereafter, the PTO issued a reexamination certificate confirming the patentability of the claims.

Biosig asserted that the “spaced relationship” limitation referred to the distance between the two electrodes. Nautilus argued that the “spaced relationship” required that the distance be greater than the width of each electrode. The district court interpreted the term to mean that there is a “defined relationship” between the two

electrodes on each side of the bar, without any particular width requirement. Nautilus then moved for summary judgment, arguing that the term “spaced relationship” was indefinite because it failed to adequately inform those skilled in the art as to the boundaries of the claims. The district court granted the motion, concluding that the term failed to inform anyone what precisely the space should be, or even supply any parameters for determining the appropriate spacing.

The Federal Circuit, applying its case law imposing a high bar to proving indefiniteness of a patent claim – requiring that a claim be “insolubly ambiguous” in order for it to be invalid – reversed. According to the Federal Circuit, the patent discerned “certain inherent parameters” that allowed a person to understand the metes and bounds of “spaced relationship.” That required that the distance be no greater than the width of a user’s hand, and no less than an “infinitesimally small” distance.

The U.S. Supreme Court vacated and remanded for further proceedings. Justice Ginsburg’s opinion began by explaining that patent claims are directed to those skilled in the relevant art. Patent claims must be precise enough to apprise the public of what is still open to them, otherwise a “zone of uncertainty” would exist that would deter others from knowing their risk of infringement. The Court announced that the correct test for definiteness requires that “a patent’s claims, viewed in light of the specification and prosecution history, inform those skilled in the art about the scope of the invention with reasonable certainty.” It rejected the Federal Circuit’s “insolubly ambiguous” test for measuring claim definiteness and remanded for reconsideration under the correct standard.

*Triton Tech of Texas, LLC v. Nintendo of America*, 753 F.3d 1375 (Fed. Cir. 2014). Triton Tech sued Nintendo, alleging that the Wii Remote used in combination with a related accessory infringed a patent directed to an input device for a computer. The district court ruled that the patent claims were invalid because the recited “integrator means associated with said input device for integrating said acceleration signals over time” had no corresponding algorithm disclosed in the specification. Triton Tech argued that the structure corresponding to the “integrator means” was a conventional microprocessor, and that the term “numerical integration” was sufficient disclosure of the algorithm because numerical integration was well-known to those of skill in the art. The Federal Circuit, however, affirmed the district court’s finding that “numerical integration” was not an algorithm but was instead an entire class of different possible algorithms used to perform integration. Accordingly, the patent claims were affirmed as being invalid for indefiniteness.

*In re Packard*, 751 F.3d 1307 (Fed. Cir. 2014). “This case raises an important question: what standard for indefiniteness should the U.S. Patent and Trademark Office (‘USPTO’) apply to pre-issuance claims?” The Federal Circuit answered its own question with the following standard: “when the USPTO has initially issued a well-grounded rejection that identifies ways in which language in a claim is ambiguous, vague, incoherent, opaque, or otherwise unclear in describing and

defining the claimed invention, and thereafter the applicant fails to provide a satisfactory response, the USPTO can properly reject the claim as failing to meet the statutory requirements of § 112(b).” The court rejected the patent applicant’s argument that the definiteness of the claims should be measured under the Federal Circuit’s “insolubly ambiguous” standard for definiteness that has been applied in district court litigation. In this case, the court affirmed the USPTO’s rejection of claims drawn to a coin change holder, noting that the patent examiner had set forth a variety of ways in which he found the claims imprecise or confusing, sometimes not even understandable, considering them in light of the written description.

**Key Take-Away:** Both the courts and the PTO are paying closer attention to clarity in patent claims, and rebuking attempts to assert vaguely-worded patents. Reliance on means-plus-function claiming techniques remains increasingly risky.

#### **4. Reissue Application Cannot Be Used to Modify Terminal Disclaimer**

*In re Dinsmore*, 757 F.3d 1343 (Fed. Cir. 2014). The Federal Circuit upheld the PTO’s determination that a patent applicant cannot use a reissue proceeding to modify a terminal disclaimer. The terminal disclaimer had been filed against another patent that was not commonly owned. According to the Federal Circuit, “applicants are ultimately seeking simply to revise a choice they made, not to remedy the result of a mistaken belief. There is not an error remediable under the reissue statute.”

#### **5. Written Description**

*Scriptpro, LLC v. Innovation Assocs, Inc.*, \_\_\_ F.3d \_\_\_, 2014 WL 3844192 (Fed. Cir. August 6, 2014). A district court ruled that a patent covering a machine for dispensing prescriptions was invalid because the patent specification did not adequately describe the invention as claimed. The district court’s ruling was based on the fact that the specification described the invention as containing sensors, whereas the claims covered a machine that did not require any sensors. The Federal Circuit reversed, concluding that although the specification contained several references to “the invention” as “broadly comprises” several components including sensors, such language was not sufficiently absolute to restrict the invention to the use of sensors. According to the Federal Circuit, “We conclude that the ‘broadly includes’/‘broadly comprises’ phrases are less than a clear statement of limitation that a skilled artisan, if being reasonable, would have to read as requiring the slot sensors at issue.” Other parts of the specification referred to functionality of the sensors as providing optional, not necessary, features to the claimed invention. The court also noted that the patent was filed with original claims that did not require sensors, suggesting that the invention was not intended to be so limited.

#### **6. Reexamination Results Trump Litigation Validity Determination**

*Fresenius USA, Inc. v. Baxter International, Inc.*, 721 F.3d 1330 (Fed. Cir. 2013),

*rehearing denied*, 733 F.3d 1369 (Fed. Cir. 2013). Fresenius brought a declaratory judgment action against Baxter, alleging that its patent was invalid and not infringed.

A district court granted summary judgment in favor of Baxter, concluding that its patent was valid. Meanwhile, in a parallel proceeding, the U.S. PTO found the identical claims to be invalid and that decision was affirmed on appeal. Then, the district court entered a final judgment enforcing the patent claims, and then the Federal Circuit affirmed the PTO's invalidity finding. The Federal Circuit held that the PTO's invalidity ruling trumped the district court's validity ruling, because the district court's ruling was not "final" while it was on appeal to the Federal Circuit. Judge Newman dissented, alleging that the decision allowed an administrative agency decision to trump a federal court decision. Four judges dissented from the denial of the petition for rehearing en banc.

*ePlus, Inc. v. Lawson Software, Inc.*, 760 F.3d 1350 (Fed. Cir. 2014). ePlus sued Lawson for infringing a patent relating to a method for using electronic databases to search for products. A jury concluded that Lawson infringed the claims, and the district court entered a permanent injunction against Lawson, enjoining Lawson from making or selling any products that infringed the patent. On appeal, the Federal Circuit overturned some but not all of the infringement rulings, leaving one infringement verdict in place, and remanding to the district court to modify the injunction. The district court also found that Lawson's redesigned products were not colorably different from its earlier products found to infringe, and found Lawson to be in contempt for violating that injunction. The court ordered Lawson to pay \$18 million for the violation, plus \$62,362 daily until it could show compliance with the injunction. Lawson appealed to the Federal Circuit. Meanwhile while Lawson's appeals were pending, the Federal Circuit affirmed the PTO's reexamination decision that invalidated the only claim at issue in the case. Following issuance of the Federal Circuit's mandate, the PTO canceled the claims in April 2014.

The Federal Circuit held, based on an 1851 Supreme Court decision not involving patents, that the district court's injunction must be set aside because the PTO had canceled the patent claim on which it was based. In other words, the PTO's cancellation of the patent claim at issue trumped the injunction issued by the district court. The Federal Circuit also set aside the district court's award of civil contempt damages. Judge O'Malley agreed that the injunction must be set aside, but dissented from the court's decision to set aside the civil contempt damages based on the later-vacated injunction.

**Key Take-Away:** Validity battles over patents are shifting to the U.S. PTO, which has increased power and authority to invalidate patents under the AIA. If a defendant can get patent litigation stayed pending outcome of proceedings at the PTO, it is likely that a patent invalidated by the PTO will result in nullification of the infringement litigation.

## **7. Ability to Force or Stop Inter Partes Reviews at the PTO**

*St. Jude Medical, Cardiology Division, Inc. v. Volcano Corp.*, 749 F.3d 1373 (Fed. Cir. 2014). St. Jude petitioned the PTO to institute an *inter partes* review of a patent. The PTO denied the petition, and St. Jude appealed the denial to the Federal Circuit. In an issue of first impression, the Federal Circuit concluded that 35 U.S.C. § 314(d), which states that “The determination by the Director whether to institute an *inter partes* review under this section shall be final and nonappealable,” precluded St. Jude from appealing the non-institution decision. The court further stated that “That declaration [in the statute] may well preclude all review by any route, which we need not decide.”

*In re Dominion Dealer Solutions, LLC*, 749 F.3d 1379 (Fed. Cir. 2014). Dominion Dealer petitioned the PTO to institute *inter partes* review of various patents owned by Autoalert. After the PTO denied the petitions, Dominion Dealer petitioned the Federal Circuit for a writ of mandamus directing the PTO to grant the petitions. The Federal Circuit concluded that the patent statute precludes appeal of a non-institution decision to the Federal Circuit, and therefore Dominion could not establish a “clear and indisputable” right to relief by way of writ of mandamus.

*In re The Proctor & Gamble Co.*, 749 F.3d 1376 (Fed. Cir. 2014). Proctor & Gamble owns 3 patents for whitening teeth, and Clio USA petitioned the PTO to institute *inter partes* review of the patents. The PTO granted the petitions, and P&G petitioned the Federal Circuit to issue a writ of mandamus directing the PTO to withdraw the orders instituting *inter partes* review on the grounds that Clio’s earlier declaratory judgment actions on the patents should have barred the institution of *inter partes* review under 35 U.S.C. § 315(a)(1). The Federal Circuit denied the petition on the grounds that the statute precludes an appeal from the decision to institute *inter partes* review, and “P&G’s mandamus petition is not a proper vehicle for challenging the institution of *inter partes* review.”

## **B. Interpretation and Infringement of Patents**

### **1. Claim Construction**

*Lighting Ballast Control LLC v. Philips Electronics North America Corp.*, 744 F.3d 1272 (Fed. Cir. 2014) (en banc). The Federal Circuit issued an en banc decision affirming that claim interpretation is an issue that is to be reviewed *de novo* on appeal, rejecting arguments that its decision in *Cybor Corp. v. FAS Technologies, Inc.*, 138 F.3d 1448 (Fed. Cir. 1998) be overturned. Four judges dissented. Note: The U.S. Supreme Court on March 31, 2014 granted certiorari in *Teva Pharmaceuticals USA v. Sandoz Inc.*, Supreme Court No. 13-854, which raises the same issue.

*In re Giannelli*, 739 F.3d 1375 (Fed. Cir. 2014). In an appeal from the U.S. PTO’s Patent Trial and Appeal Board (PTAB) which affirmed a patent examiner’s rejection of claims directed to a rowing machine as obvious over a chest press exercise machine. At issue was the meaning of the claim phrase “first handle portion *adapted*



*to be moved* from a first position to a second position by a pulling force . . . in a rowing motion.” The PTAB interpreted this language to be merely an intended use for the claimed machine, and held that the chest press machine could be used in the manner claimed. The Federal Circuit reversed, explaining that “the phrase ‘adapted to’ is frequently used to mean ‘made to,’ ‘designed to,’ or ‘configured to’ . . . . Although the phrase can also mean ‘capable of’ or ‘suitable for,’ here the written description makes clear that ‘adapted to’ . . . has a narrower meaning, viz., that the claimed machine is designed or constructed to be used as a rowing machine whereby a pulling force is exerted on the handles.” The Federal Circuit concluded that “there is no question that the ‘447 patent does not have handles that are adapted to be pulled in a rowing motion.” **Note:** This case may be helpful to rebut recent U.S. PTO patent examiners and PTAB decisions that dismiss “configured to” or “adapted to” language in patent claims as having “no patentable weight.”

## **2. Disclaimer of Claim Scope**

*Golden Bridge Technology, Inc. v. Apple Inc.*, 758 F.3 1362 (Fed. Cir. 2014). Golden Bridge sued Apple for infringing patents relating to a communication system. Golden Bridge had previously asserted one of the patents against another defendant, and the parties in that earlier litigation had stipulated to the meaning of certain claim terminology (the meaning of the word “preamble”). While an appeal from that earlier litigation was pending, Golden Bridge had also filed a continuation application and defended a reexamination of the asserted patent in the U.S. PTO. In both the continuation application and the reexamination, Golden Bridge submitted an Information Disclosure Statement (IDS) that included the claim construction order from the earlier litigation including the stipulated definition of the claim term “preamble.” In this lawsuit, the district court relied on the claim term definition contained in the IDS and granted summary judgment in favor of Apple. The Federal Circuit affirmed, concluding that Golden Bridge’s submissions “during prosecution of its stipulated construction for the term preamble constitute disclaimer. Although we generally construed terms according to their plain and ordinary meanings to one of ordinary skill in the art, we depart from that meaning where there is disclaimer.” According to the court, “it would have been natural for both the PTO and the public to rely upon the stipulation in determining the scope of the claimed invention.”

## **3. Induced Infringement Requires Evidence of Direct Infringement**

*Limelight Networks, Inc. v. Akamai Technologies*, 134 S.Ct. 2111 (2014). M.I.T. owns a patent that claims a method of delivering electronic data using a content delivery network. Akamai, the exclusive licensee of the patent, contracts with website owners to improve content delivery by designating certain components of the web site to be stored on Akamai’s servers in a process known as “tagging.” By serving the content from different servers, Akamai is able to increase the speed with which Internet users access the content on the websites. Limelight networks also carries out several steps of the patented method, but instead of tagging those components of the websites that are stored on its servers as claimed, Limelight

requires its customers to do their own “tagging.”

In 2006, Akamai sued Limelight for patent infringement, and a jury awarded \$40 million in damages. After the jury verdict, the Federal Circuit decided another case, *Muniauction, Inc. v. Thomson Corp.*, 532 F.3d 1318 (Fed. Cir. 2008), which held that a party could only be liable for infringement if a single entity performed all of the claimed method steps, or if a single defendant “exercises control or direction” over the entire process such that every step is attributable to the controlling party. Because the defendant in *Muniauction* did not exercise control or direction over its customers’ performance of the steps, no infringement could be found. In light of *Muniauction*, the district court granted Limelight’s motion to set aside the verdict on the basis that no direct infringement existed, and because Limelight did not control or direct its customer’s “tagging” operation, no infringement could be found.

The Federal Circuit initially affirmed, concluding that a defendant that does not itself perform all of the steps of a patented method can be eligible for direct infringement only “when there is an agency relationship between the parties who perform the method steps or when one party is contractually obligated to the other to perform the steps.” Because Limelight did not have control over its customers, the customer’s tagging operations could not be attributed to Limelight.

The Federal Circuit reheard the *Limelight* case en banc and reversed. The en banc court did not revisit its direct infringement case law, but instead concluded that “the evidence could support a judgment in Akamai’s favor on a theory of induced infringement” under 35 U.S.C. § 271(b). This was true, according to the Federal Circuit, because liability for induced infringement arises when a defendant carries out some steps constituting a method patent and encourages others to carry out the remaining steps, even if no one would be liable as a direct infringer.

The Supreme Court reversed and remanded, beginning with the proposition that there can be no liability for induced infringement unless there is direct infringement. Justice Alito blasted the Federal Circuit, stating that “The Federal Circuit’s analysis fundamentally misunderstands what it means to infringe a method patent. A method patent claims a number of steps; under this Court’s case law, the patent is not infringed unless all the steps are carried out.” The Court explained that “where there has been no direct infringement, there can be no inducement of infringement under § 271(b).” The Court rejected the analogy that tort law imposes liability on a defendant who harms another through a third party, even if that third party would not himself be liable. “Because Limelight did not undertake all steps of the ‘703 patent and cannot otherwise be held responsible for all those steps, respondents’ rights have not been violated.” The Court also rejected an analogy to the federal aiding and abetting statute. The Court did, however, acknowledge the danger in permitting a would-be infringer to evade liability by dividing performance of a method claim with another whom the defendant neither directs nor controls, but noted that such an anomaly “would result from the Federal Circuit’s interpretation of § 271(a) in *Muniauction*,” suggesting that the holding in that case was questionable. The Court

also rejected Akamai’s suggestion that the Supreme Court review the Federal Circuit’s earlier *Muniauction* decision, stating that “we decline to do so today.” The case was remanded to the Federal Circuit with the caveat that “the Federal Circuit will have the opportunity to revisit the § 271(a) question if it so chooses.”

**Key Take-Away:** The importance of careful claim drafting, particularly when drafting method claims involving computer technology, cannot be overemphasized. Claims that involve participation by more than one person or corporate entity may be difficult to enforce in court, leaving patent owners with little or no recourse.

#### **4. Prosecution History Estoppel Applies to Design Patents**

*Pacific Coast Marine Windshields Ltd v. Malibu Boats, LLC*, 739 F.3d 694 (Fed. Cir. 2014). In an issue of first impression, the Federal Circuit held that the doctrine of prosecution history estoppel applies to design patents. In this case, the patent applicant filed a design patent application claiming an ornamental design for a marine windshield with a frame, a tapered corner post with vent holes and without vent holes, and with a hatch and without a hatch. The patent examiner issued a restriction requirement, identifying 5 different designs. The applicant selected the first group, corresponding to a windshield having four vent holes and a hatch and canceled the figures corresponding to the non-elected group. After the patent issued, the patent owner sued Malibu Boats for infringement based on an accused windshield having only three vent holes. The Federal Circuit affirmed the district court’s grant of summary judgment of non-infringement, concluding that cancellation of figures and striking references to alternative embodiments constituted a surrender of claim scope. It rejected the argument that estoppel was limited to amendments made to avoid prior art.

### **C. Enforcement of Patents**

#### **1. Standards-Essential Patents**

*Apple Inc. v. Motorola, Inc.*, 757 F.3d 1286 (Fed. Cir. 2014). In a patent infringement suit brought by Apple against Motorola, Motorola counterclaimed for infringement of a patents that was deemed essential to a standard. The district court granted Apple’s motion for summary judgment that Motorola was not entitled to an injunction on the standard-essential patent, because Motorola had agreed to license it on fair, reasonable, and nondiscriminatory (“FRAND”) terms. The Federal Circuit stated that “to the extent the district court applied a *per se* rule that injunctions are unavailable for SEPs [standard-essential patents], it erred. While Motorola’s FRAND commitments are certainly criteria relevant to its entitlement to an injunction, we see no reason to create, as some *amici* urge, a separate rule or analytical framework for addressing injunctions for FRAND-committed patents.” Instead, the court explained that the framework set forth by the Supreme Court in its 2006 *eBay v. MercExchange* case should govern whether an injunction is issued. For example, the Federal Circuit noted that an injunction might be warranted where an

infringer refuses a FRAND royalty or unreasonably delays negotiations to the same effect. In this case, however, the Federal Circuit affirmed the summary judgment that no injunction should issue, because Motorola had failed to establish irreparable harm. “Considering the large number of industry participants that are already using the system claimed in the ‘878 patent, including competitors, Motorola has not provided any evidence that adding one more user would create such harm.”

*Commonwealth Scientific and Industrial Research Organization v. Cisco Systems, Inc.*, 2014 WL 3805817 (E.D. Tex. July 23, 2014). Commonwealth Scientific (CSIRO) owns a patent that is essential to practicing a standard-essential invention relating to Wi-Fi. The IEEE adopted the standard, and Cisco agreed to a bench trial on the amount of damages it must pay for using the standard. The district court rejected CSIRO’s damages model as flawed, concluding that its \$30 million theory was based on an expert who had wide variability in estimated profit premiums attributable to the patented technology. The court also found that the expert’s “drastic final apportionment is arbitrary, capricious, and supported by no sound economic methodology.” The court similarly rejected Cisco’s total damages theory of \$1.1 million, because it was based primarily on the prices of chips that implemented various features of the patented invention, rather than the combination of techniques including other components. Relying on the so-called “hypothetical negotiation” between the parties, the district court ultimately focused on an informal offer of \$0.90 per product that Cisco had made to CSIRO even though the offer was made years after the so-called hypothetical negotiation would have taken place. Based on this offer, the district court concluded that a range of \$0.90 to \$1.90 was appropriate (the upper bound set by CSIRO’s “voluntary” licensing program to others), and ultimately awarded total damages in the amount of \$16 million.

*Microsoft Corp. v. Motorola, Inc.*, 2013 WL 2111217 (W.D. Wash. Apr. 25, 2013). Microsoft sued Motorola for breach of contract, alleging that Motorola had an obligation to license patents to Microsoft at a reasonable and non-discriminatory (“RAND”) rate, and that Motorola breached its RAND obligations by sending two offer letters. The district court held a bench trial in November 2012 with the aim of determining a RAND licensing rate and RAND royalty range for Motorola’s patents.

Both Microsoft and Motorola were members of the IEEE and ITU organizations, both of which create standards for various types of technology. The standards at issue involve WiFi (802.11) and video coding technology (H.264). Motorola owned patents that were “essential” to both standards (meaning that to be compliant with the standards, one would necessarily have to use patented technology), and Motorola had committed to license them on RAND terms. Motorola sent two letters to Microsoft, offering to license each set of patents for a royalty rate of 2.25% of the price of any end product that incorporate the patented technology. The total cost to Microsoft would have been \$100 million to \$125 million per year. Microsoft then sued for breach of contract, and in a series of orders, the district court found that Microsoft could sue as a third-party beneficiary, and that Motorola’s commitments required that initial offers by Motorola must be made in good faith.

The court started by noting that both standards organizations required members to disclose a potentially essential patent and to either (1) agree to license the patents for free; or (2) license the patents on RAND terms; or else (3) the approved standard would not include the patented provisions. The court noted that certain industry standards can require hundreds or thousands of essential patents, and certain devices such as PCs may be required to comply with as many as 90 different standards. Motorola had submitted documents to the European Telecommunication Standards Institute (ETSI) in which it pointed out that in order to comply with RAND, compensation must reflect the patent owner's proportion of all essential patents, such that judges should look at the overall cumulative royalty for a given standard, not just offers made by one patent owner.

Microsoft and Motorola submitted competing theories regarding how a RAND range or rate should be calculated. Motorola owned 16 patents that are essential to the H.264 standard, but the court concluded that most of Microsoft's products made only minor use of the technology. Motorola owned 24 patents that it asserted are essential to the 802.11 standard, and Motorola agreed that only Microsoft's XBOX used its 802.11 standards-essential patents (SEPs).

Motorola's proposed license fee of 2.25% was based on expert testimony that relied on earlier settlements with different companies for the same patents. The court discounted this testimony because the earlier settlements were made in the course of settling patent litigation, and in one case, included other patents not at issue in this case. The court noted concerns about "patent stacking" in view of the relatively minor contribution that Motorola's patents made to the standard.

Microsoft's proposed approach focused on two patent pools, one for the H.264 standard and the other for the 802.11 standard. In such pools, each participant received a share of the total royalties based on the number of its patents included in the pool. The first 100,000 units were royalty-free; for units between 100,000 and 5 million, the royalty was \$0.20 per unit; and for volumes above 5 million, the royalty rate was \$0.10 per unit, with a cap of \$6.5 million. The court noted evidence tending to show that royalty rates in patent pools are generally lower than rates negotiated independently. The court also concluded that patent pools did not consider the importance of individual patents to the standard. Consequently, the court found that a patent pool rate did not per se constitute a RAND rate. Nevertheless, in view of the success in licensing the patent pool, the court found that it was a "strong indicator" of a RAND royalty rate.

Starting with the H.264 pool, the court considered the effect of adding Motorola's H.264 patents to the pool, and concluded (based on expert testimony) that Microsoft would end up paying 0.185 cents per unit, but that Motorola would also obtain value in the form of having full access to other patents included in the pool. Evidence from Microsoft showed that it received about twice as much in value from the pool as it paid in, so the court concluded a similar amount for Motorola would apply. This

meant that Motorola would receive 0.555 cents per unit as a lower-end RAND rate. The court found no reason to increase this rate, partly because there was no evidence concerning how important to the pool Motorola's patents were. After considering anti-stacking concerns and evidence of a highest fee of \$1.50 per unit discussed during formation of the pool, the court set an upper bound of \$0.16389 per unit.

Moving to the 802.11 pool, the court started with a calculated pool value royalty of \$0.05 per unit but adjusted it to account for the fact that Motorola no longer claimed that 53 of its U.S. patents were essential to the 802.11 standard (adjusted down to 24 patents) and concluded that Motorola's royalty payments would be \$0.06114 per unit, or 6.114 cents per unit.

The court also considered other evidence based on other comparable scenarios, resulting in royalty rates of 3 to 4 cents per unit, and 0.8 to 1.6 cents per unit. **The court then concluded that "In relation to the amount Motorola seeks in this litigation -- \$6.00 - \$8.00 per Xbox unit – these three indicators are very close to one another.** The court then averaged the three royalty values and arrived at a rate of 3.471 cents per unit. The court also adopted a lower range value of 0.8 cents and an upper range value of 19.5 cents per unit.

*Microsoft Corp. v. Motorola, Inc.*, 2013 WL 4053225 (W.D. Wash. Aug 12, 2013, 2013). Following its decision on RAND royalty rates (see decision above), Microsoft moved for summary judgment that Motorola had breached its RAND obligations by offering to license the patents at a rate of 2.25% of the cost of each unit, which was a breach of the duty of good faith and fair dealing. Microsoft also contended that Motorola's seeking of injunctive relief and the ITC frustrated the purpose of Motorola's RAND obligations. The district court denied the motion, stating that disputed issues of fact should be decided by a jury, including such questions as whether the offers were commercially reasonable.

**Note1:** On September 4, 2013, a jury ordered Motorola to pay Microsoft \$14.5 million for breaching its obligation to license its standard-essential patents to Microsoft on fair terms. **Note2:** The decision is currently on appeal at the 9<sup>th</sup> Circuit.

*In re Innovatio IP Ventures, LLC Patent Litigation (MDL)*, 2013 WL 5593609 (N. D. Ill. Oct. 3, 2013). Innovatio sued numerous hotels, coffee shops, restaurants, supermarkets, and other users of Wi-Fi internet technology throughout the United States, alleging that providing Wi-Fi access for their customers infringed 23 patents owned by Innovatio. The manufacturers of the devices, including Cisco, Motorola, HP and others, filed declaratory judgment actions against Innovatio, seeking a declaration that their products do not infringe and that the patents are invalid. Innovatio then alleged that the manufacturers' devices also infringed, and the cases were consolidated into this multi-district litigation case.

The manufacturers alleged that Innovatio's patents are "essential" to the IEEE 802.11 wireless standard, and that Innovatio is therefore subject to the promises of the prior owners of the patents to license the patents on reasonable and non-discriminatory (RAND) terms. The parties agreed to waive a jury trial and allow the court to decide all RAND-related issues in a bench trial. The manufacturers alleged that all of the asserted claims were "essential" to the standard, whereas Innovatio contended that only 168 of the asserted claims are essential, but others were not.

The court started by noting the IEEE's requirement that patent owners of standard-essential patents promise to license their patents on RAND terms before the standard is adopted. Innovatio's patents were previously owned by Intermecc Technologies Corp, Norand Corp., and Broadcom, each of which had agreed with the IEEE to license any standard-essential technology covered by their patents on RAND terms. The court held that those agreements were binding on Innovatio, and that Innovatio could be held in breach of the agreement if it failed to live up to the promises. The court then reviewed the IEEE's bylaws regarding standards and "standards-essential" patents. The court also treated all the different variations of the 802.11 standard as a single standard for purposes of the lawsuit.

The court adopted the meaning of "essential patent claim" contained in the IEEE bylaws, which referred to a patent claim the use of which was necessary to create a compliant implementation of either mandatory or optional parts of the standard, when there was no commercially and technically feasible non-infringing alternative. The court put the burden on the manufacturers to prove that (1) the only commercially and technically feasible way to implement a particular mandatory or optional part of the standard was to infringe the claims; and (2) the patent claim includes technology that is explicitly required by the standard. Based on this definition, the court concluded that all of the categories of claims asserted by the manufacturers were "essential" and thereby subject to RAND licensing terms. In some cases, the court relied on the fact that non-infringing alternatives would not be commercially feasible.

Following a bench trial in September 2013, the court determined that the RAND rate to be paid to Innovatio for licensing its portfolio of 19 standard-essential patents is 9.56 cents for each Wi-Fi chip used or sold in the United States. The court looked to Judge Robart's methodology in *Microsoft v. Motorola*, 2013 WL 2111217, involving similar issues, and followed a similar procedure (essentially, a modified Georgia-Pacific factors analysis) to conduct a hypothetical negotiation between the patent owner and the manufacturers. The court discussed the well-known "royalty stacking" problem, in which certain standards can involve hundreds if not thousands of patents, making the cumulative royalty payment excessive. The court also noted that the RAND rate must be set high enough to ensure that innovators in the future have an incentive to invest in future developments.

The court rejected Innovatio's argument that the royalty base should be the product incorporating the Wi-Fi functionality, such as a laptop computer or router, as

speculative and not based on an established method of analysis; the court also found that Innovatio failed to properly apportion the value of the patented technology in the products. The court also reviewed comparable licenses and other factors before arriving at its RAND royalty rate, based in part on the manufacturers' "top-down" approach that focused on the price of a Wi-Fi chip.

*Realtek Semiconductor Corp. v. LSI Corp.*, 2014 WL 2738226 (N.D. Cal. June 16, 2014). LSI Corp owns two patents that it states are "essential" to the 802.11 WiFi standard, and its predecessor (Agere) submitted Letters of Assurance (LOA) to the IEEE stating that it was prepared to grant licenses on a FRAND basis (fair, reasonable, and non-discriminatory). Agere contacted Realtek to offer a license under the patents at a rate of 5%, but Realtek did not respond. Years later, after LSI acquired Agere, LSI sent a letter to Realtek demanding that it cease and desist from infringing the patents. Less than a week later, LSI filed a complaint in the ITC, seeking to block Realtek products from being imported into the U.S. A month later, Realtek sent a letter to LSI, requesting that it make the patents available under FRAND license terms. LSI responded with an offer letter that applied a royalty rate to the total value of the end product rather than to the value of the components that Realtek supplied. Realtek then sued LSI, asserting that LSI breached its FRAND licensing obligations, and Realtek moved for partially summary judgment. The district court granted the motion, concluding that Agere's LOA letter to the IEEE constituted a binding contract to license their patents, and that filing an ITC action before offering a RAND license constituted a breach of that agreement.

Beginning in February 2014, the court held a jury trial to determine Realtek's breach of contract damages and the RAND rates for the two patents. The jury awarded \$3.8 million to Realtek for breaching of contract and found RAND royalty rates of 0.12% for one patent and 0.07% for the other patent. Realtek then moved for a permanent injunction enjoining LSI from further demanding royalties beyond the jury's verdict and from seeking to enforce any patents in the ITC without first offering Realtek a license. The court denied the injunction because the ITC had ruled that LSI failed to prove infringement, and thus there was no irreparable harm. The court did, however, grant Realtek's request for declaratory relief, ruling that upon Realtek's request for a license, to be in compliance with its RAND obligations, LSI must offer Realtek a license to the patents at the rates found by the jury.

## **2. Injunctions**

*Apple Inc. v. Samsung Electronics Co.*, 735 F.3d 1352 (Fed. Cir. Nov. 18, 2013). Apple sued Samsung for infringing various patents relating to smartphones. A jury found that various Samsung smartphones infringed six of Apple's patents (three design patents and three utility patents), and awarded Apple more than \$1 billion in damages. The patents relate generally to the ornamental appearance of the rounded phone, and various touch-screen features such as a "pinch-to-zoom" feature. After trial, Apple moved for a permanent injunction, but the district court denied the motion. On appeal, the Federal Circuit affirmed the denial of the permanent



injunction as to the design patents, agreeing with Samsung that Apple had failed to show irreparable harm from the infringement because it did not establish a sufficient “causal nexus” between the harm and Samsung’s patent infringement. Apple had failed to submit sufficient evidence that consumers were buying Samsung’s products because of the features claimed in the design patents.

As to Apple’s utility patents, however, the Federal Circuit held that the district court erroneously rejected Apple’s survey evidence showing that consumers were willing to pay a premium for the features claimed in those patents. As to the inadequacy of legal damages to compensate for infringement, the Federal Circuit agreed that Apple’s past agreements to license the patents was relevant, but faulted the district court for placing too much weight on Apple’s previous licenses, some of which were entered into in settlement of litigation. As to the public interest factor, the Federal Circuit agreed with the district court’s conclusion that an injunction would prevent the public from enjoying a wide range of non-infringing features based on “limited non-core functions.”

### **3. Attorney’s Fees**

*Octane Fitness, LLC v. ICON Health & Fitness, Inc.*, 134 S.Ct. 1749 (2014). Section 285 of the patent statute permits a district court to award attorney’s fees “in exceptional cases . . . to the prevailing party.” Existing Federal Circuit case law held that a case could be held “exceptional” in only two situations: (1) when there has been some material inappropriate conduct, or (2) when the litigation is both “brought in subjective bad faith” and is “objectively baseless.” In this case, ICON sued Octane for infringing several claims of a patent relating to exercise equipment. The district court granted Octane’s motion for summary judgment, concluding that the patent was not infringed. Octane moved for attorney’s fees, but the district court denied the motion because Octane did not show that the suit was “objectively baseless” or that ICON had brought it in subjective bad faith. The Federal Circuit affirmed, but the Supreme Court granted certiorari, reversed and remanded.

The Supreme Court began with reference to dictionary definitions of the word “exceptional” from the 1930s, which were in use at the time Congress enacted the 1952 Patent Act. In that context, the word meant “out of the ordinary course,” “unusual,” or “special.” “We hold, then, that an ‘exceptional’ case is simply one that stands out from others with respect to the substantive strength of a party’s litigating position (considering both the governing law and the facts of the case) or the unreasonable manner in which the case was litigated. District courts may determine whether a case is ‘exceptional’ in the case-by-case exercise of their discretion, considering the totality of the circumstances.”

The Supreme Court rejected the Federal Circuit’s “rigid and mechanical” formulation established in *Brooks Furniture Mfg, Inc. v. Dutalier Int’l, Inc.*, 393 F.3d 1378 (Fed. Cir. 2005), noting that its standard was nearly the same as that for “sanctionable conduct” under Federal Rule of Civil Procedure Rule 11. Instead, “a

district court may award fees in the rare case in which a party's unreasonable conduct – while not necessarily independently sanctionable – is nonetheless so 'exceptional' as to justify an award of fees. Finally, "we reject the Federal Circuit's requirement that patent litigants establish their entitlement to fees under § 285 by 'clear and convincing evidence.'" Instead, such entitlement should be based on a preponderance of the evidence standard.

*Highmark Inc. v. Allcare Health Mgt System, Inc.*, 134 S.Ct 1744 (2014). The patent statute provides that a court in exceptional cases may award reasonable attorney fees to the prevailing party. Highmark sued Allcare seeking a declaratory judgment that its patent was invalid, unenforceable, and not infringed. The district court entered a final judgment of noninfringement in favor of Highmark and the Federal Circuit affirmed. Highmark then moved for attorney fees, which the district court granted based on Allcare's pattern of "vexatious" and "deceitful" conduct throughout the litigation. Among other things, the court found that Allcare had maintained infringement claims against Highmark well after such claims had been shown by its own experts to be without merit, and asserted frivolous defenses. The Federal Circuit reversed in part, reviewing *de novo* the exceptional-case determination. Relying in part on its *Octane Fitness* decision (discussed above), the U.S. Supreme Court vacated and remanded, concluding that "an appellate court should apply an abuse-of-discretion standard in reviewing all aspects of a district court's § 285 determination."

**Key Take-Away:** It will be increasingly easier to get attorney's fees for meritless patent cases, which might discourage so-called "patent trolls" in the coming months and years. Time will tell how far courts are willing to go in making such awards.

#### **4. Induced Infringement at the ITC**

*Suprema, Inc. v. International Trade Commission*, 742 F.3d 1350 (Fed. Cir. Dec. 13, 2013), *vacated and rehearing en banc granted*, 2014 WL 3036241 (May 13, 2014). In an issue of first impression, the Federal Circuit held that the ITC may not issue an exclusion order barring importation of products that infringe only under a theory of induced infringement, where no direct infringement occurs until after importation of the articles the exclusion order would bar. In this case, the direct infringement did not occur until after Mentalix combined Suprema's products with its own software, thus making Suprema allegedly liable for induced infringement. The Federal Circuit based its decision on the language of the ITC statute (section 337), which refers to importation of "articles that . . . infringe a valid and enforceable United States patent."

#### **5. Infringement Damages**

*Apple Inc. v. Motorola, Inc.*, 757 F.3d 1286 (Fed. Cir. 2014). Apple sued Motorola for infringing 3 patents relating to various features of smartphones. The district court (Circuit Judge Posner sitting by designation) excluded Apple's damages expert from

testifying regarding damages because that expert relied upon a technical expert to identify a potential design-around option that could have avoided infringement, and relied on the existence of that design-around option for his damages assessment. According to the Federal Circuit, “The district court’s decision states a rule that neither exists nor is correct. Experts routinely rely upon other experts hired by the party they represent for expertise outside of their field.” The court noted that patent damages experts often rely on technical expertise outside of their field when evaluating design-around options or valuing the importance of the specific infringing features in a complex device. The Federal Circuit also rejected the district court’s concerns that the technical expert who was hired by Apple could have been biased. According to the Federal Circuit, “this concern is addressed by the weight given to the expert’s testimony, not its admissibility.” The Federal Circuit also rejected the district court’s conclusion that Apple was not entitled to any damages because of its purported lack of admissible evidence, noting that the patent statute provides that the court must award damages “in no event less than a reasonable royalty.” The court stated that “If a patentee’s evidence fails to support its specific royalty estimate, the fact finder is still required to determine what royalty is supported by the record.”

#### **6. Patent Co-Owner Can Preclude Infringement Suit**

*STC.UNM v. Intel Corp.*, 754 F.3d 940 (Fed. Cir. 2014). STC.UNM sued Intel for patent infringement, but the district court dismissed the suit for lack of standing because non-party Sandia Corp. was a co-owner of the patent but it had not voluntarily joined as a co-plaintiff and could not be involuntarily joined. The Federal Circuit affirmed, concluding that all co-owners must consent to join as plaintiffs in an infringement suit. The Federal Circuit explained that there are only scenarios that can overcome this rule: First, when a patent owner has granted an exclusive license, he can be involuntarily joined. Second, if the co-owner waives his right to join the suit, his co-owners may force him to join in a suit against infringers. Because neither of those scenarios was present, the Federal Circuit affirmed the dismissal. Judge Newman dissenting, arguing that Rule 19 provided for involuntary joinder of the non-consenting co-owner of the patent.

#### **7. Stays of Litigation Pending PTO Review of Patent**

*Virtualagility Inc. v. Salesforce.com, Inc.*, 759 F.3d 1307 (Fed. Cir. 2014). Virtualagility sued Salesforce.com and several other defendants for infringing a U.S. patent directed to processing management information. Shortly after the suit was filed, Salesforce.com filed a petition with the U.S. Patent Trial and Appeal Board (PTAB) seeking post-grant review of all claims of the patent under the so-called “Covered Business Method (CBM) Review” program. A few days later, the defendants filed a motion to stay the district court proceedings pursuant to AIA § 18(b)(1). While the motion was pending, the PTAB granted the petition to review the patent. The district court thereafter denied the motion to stay, and the defendants appealed the denial to the Federal Circuit, which is permitted by statute as an

interlocutory appeal.

The Federal Circuit looked at the four factors provided under the statute to decide whether an a stay should be granted: (1) whether a stay would simplify the issues for trial; (2) whether discovery is complete; (3) whether a stay would prejudice the nonmoving party; and (4) whether a stay would reduce the burden of litigation.

The Federal Circuit began by sidestepping the standard of review, holding that even under a more deferential abuse of discretion standard, the district court's decision to deny a stay was erroneous. According to the Federal Circuit, "the district court erred as a matter of law to the extent that it decided to 'review' the PTAB's determination that the claims of the '413 patent are more likely than not invalid in the posture of a ruling on a motion to stay." The Federal Circuit also found it significant that the PTAB granted review of all claims of the single asserted patent. "This CBM review could dispose of the entire litigation: the ultimate simplification of issues."

## **8. Consumer Groups May Lack Standing to Attack Patents**

*Consumer Watchdog v. Wisconsin Alumni Research Foundation*, 753 F.3d 1258 (Fed. Cir. 2014). Consumer Watchdog requested inter partes reexamination of a patent directed to human embryonic stem cell cultures. It appealed from the PTAB's decision affirming the patentability of the claims of the patent. The Federal Circuit dismissed the appeal, concluding that Consumer Watchdog lacked Article III standing to pursue the appeal. In particular, Consumer Watchdog had no involvement in any research or commercial activities involving human embryonic stem cells, and had failed to identify any injury aside from the PTAB's denying the particular outcome it desired. "Because Consumer Watchdog has not identified a particularized, concrete interest in the patentability of the '913 patent, or any injury in fact flowing from the Board's decision, it lacks standing to appeal the decision affirming the patentability of the amended claims."

## **9. Contempt Order Not Appealable Until Sanctions Determined**

*Arlington Industries, Inc. v. Bridgeport Fittings, Inc.*, 759 F.3d 1333 (Fed. Cir. 2014). Arlington sued Bridgeport in for infringing a patent relating to a method for connecting electrical cables to a junction box. The parties entered into a settlement agreement under which Bridgeport agreed to be enjoined from making and selling certain products. Years later, after Bridgeport had redesigned its products, Arlington sought a contempt order holding that the redesigned connectors violated the injunction. The district court found that Bridgeport was in contempt of the injunction and also expressly enjoined the sale of the redesigned connectors, but before it determined any sanctions for the contempt, Bridgeport appealed to the Federal Circuit. The Federal Circuit dismissed the appeal, concluding that because the district court had not modified the injunction but merely interpreted it, the

decision was not a final decision ripe for appeal. The court concluded that the earlier 2004 injunction and the newly-issued order were directed to the same parties, applied to the same activities, and were in force for the same time period. Even though the district court's newly-issued injunction differed slightly in wording from the earlier 2004 order, it did not change the scope of the earlier injunction, which applied to products that were not "colorably different" from the ones found to infringe.

#### **10. Declaratory Judgment Jurisdiction Where Customers Are Sued**

*Microsoft Corp. v. Datatarn, Inc.*, 755 F.3d 899 (2014). Datatarn sued several customers of Microsoft and SAP for infringing two of its patents. Datatarn sent the customers claim charts showing how their use of Microsoft's and SAP's software infringed the patents, with reference to certain Microsoft and SAP product manuals showing how to use the software. After several of the customers demanded indemnity from Microsoft and SAP, the latter filed declaratory judgment actions against Datatarn, seeking a declaratory judgment that the patents were invalid and not infringed. The district court refused to dismiss the DJ actions because Datatarn had provided claim charts showing infringement and because of the indemnification demands from the customers. The Federal Circuit affirmed the denial of the dismissal motions, concluding that although it was not enough to base jurisdiction on the indemnity demands, the fact that Datatarn provided claim charts pointing to Microsoft and SAP manuals as the basis for infringement gave rise to a substantial controversy regarding whether they induced infringement.

#### **11. Inequitable Conduct**

*Apotex Inc. v. UCB, Inc.*, \_\_\_ F.3d \_\_\_, 2014 WL 3973498 (Fed. Cir. August 15, 2014). Since the Federal Circuit's 2011 en banc decision in *Therasense Inc. v. Becton, Dickinson and Co.*, 649 1276 (Fed. Cir. 2011), it has been much harder to prove that a patent applicant engaged in inequitable conduct that renders a patent unenforceable. This is a rare case in which such a ruling was upheld. Apotex owns a patent for a process for manufacturing a pharmaceutical drug that treats hypertension. Apotex's founder and chairman drafted the patent application, which included certain examples of experiments that were never conducted. He also hired an expert to persuade the U.S. PTO to allow the patent, based partly on false information regarding what was known in the prior art. The district court found that the founder's testimony at trial was not credible, and that he intended to mislead the PTO based on the never-conducted experiments and the falsely submitted information. The Federal Circuit affirmed, concluding that the patent specification and the affirmative misrepresentations were material to patentability (i.e., the PTO would never have issued the patent absent the misconduct). The Federal Circuit also concluded that there was intent to deceive the PTO, based on the founder's extensive prior patent prosecution experience. Accordingly, the patent was held to be unenforceable and the infringer was not liable for patent infringement.

#### **12. Patent Exhaustion**

*Lifescan Scotland, Ltd. v. Shasta Tech., LLC*, 734 F.3d 1361 (Fed. Cir. Nov. 4, 2013). Lifescan, which manufactures the “OneTouch Ultra” blood glucose monitoring system, sued Shasta for infringement of patents covering a method of measuring blood glucose. The method refers to steps performed by a measuring strip and steps performed by a blood glucose meter. Lifescan sells 40% of its meters below cost, and distributes the remaining 60% of its meters for free, but it makes money by selling the blood glucose test strips for use with its meters, with the expectation that customers will purchase strips from Lifescan. Shasta does not sell blood glucose meters, but it does sell test strips that are designed to be used with Lifescan’s meters. Lifescan sued for indirect infringement, arguing that people who purchased test strips from Shasta would be direct infringers. The district court agreed, granting a preliminary injunction against Shasta. The district court concluded that Lifescan’s free distribution of its meters did not “exhaust” its patent rights because it had received no money for the meters so distributed. It also concluded that exhaustion did not apply because the “inventive feature” of the patent related to the test strips, not to the meters.

The Federal Circuit reversed, concluding that the Supreme Court’s decision in *Quanta Computer v. LG Electronics*, 553 U.S. 617 (2008), was controlling. According to the Federal Circuit, *Quanta* confirmed that the exhaustion doctrine applied to method patents, including where the sale of an item “that embodied the method” were sold. In this case, the sale of the meters by Lifescan had no reasonable non-infringing use other than to be used with the test strips. The Federal Circuit rejected Lifescan’s argument that the meters had some reasonable non-infringing uses. The court also rejected Lifescan’s argument that the meters did not embody the “inventive features,” pointing to prosecution history showing that claims directed to the test strips by themselves were rejected, and only claims involving the meter were allowed. Because the “inventive features” were in the meters that were given away for free, the patent owner exhausted any patent rights in the meters, including method claims covering the meters, which had no other use other than in the claimed method. The court also noted that “allowing LifeScan to control sale of the strips would be akin to allowing a tying arrangement whereby the purchasers of the meters could be barred from using the meters with competing strips.” The court explained that “the authorized transfer of ownership in a product embodying a patent carries with it the right to engage in that product’s contemplated use.” Finally, the court rejected Lifescan’s argument that because it gave the meters away for free, it had not received any reward for its patent. The court explained that “in the case of an authorized and unconditional transfer of title, the absence of consideration is no barrier to the application of patent exhaustion principles.” According to the court, “patent exhaustion principles apply equally to all authorized transfers of title in property, regardless of whether the particular transfer at issue constitute a gift or a sale.”

Judge Reyna dissented, concluding that the test strips, and not the meter, embodied the “essential features” of the patented method. Judge Reyna explained that the steps performed by the meter could only be carried out by the unique configuration of the

test strips.

*Keurig, Inc. v. Sturm Foods, Inc.*, 732 F.3d 1370 (Fed. Cir. Oct. 17, 2013). Keurig sells single-serve coffee brewers and cartridges for use in those brewers, and holds patents directed to brewers and methods of using them to make beverages. Sturm sells cartridges for use in Keurig’s brewers, but does not itself sell brewers. Keurig sued, alleging that the use of Sturm’s cartridges in Keurig’s brewers directly infringed its patents. The district court granted summary judgment of non-infringement based on the principle of patent exhaustion – i.e., that Keurig’s sale of its brewers exhausted any patent rights in the method of using the cartridges in combination with the brewers. The Federal Circuit affirmed, concluding that method claims are exhausted by an authorized sale of an item that substantially embodies the method if the item (1) has no reasonable noninfringing use, and (2) includes all inventive aspects of the claimed method. The court also held that where a person has purchased a patented machine of the patentee, the purchase carries with it the right to use of the machine so long as it is capable of use. According to the court, Keurig sold its patented machines without conditions and its purchasers obtained the right to use them in any way they chose. Consequently, Keurig’s right to assert infringement of the method claims were exhausted by the authorized sale of Keurig’s patented brewers. “Here, Keurig is attempting to impermissibly restrict purchasers of Keurig brewers from using non-Keurig cartridges by invoking patent law to enforce restrictions on the post-sale use of its patented products.” The court also rejected the argument that patent exhaustion must be determined on a claim-by-claim basis: “The Court’s patent exhaustion jurisprudence has focused on the exhaustion of the patents at issue in their entirety, rather than the exhaustion of the claims at issue on an individual basis.”

### **13. Induced Infringement – Belief in Invalidity as Defense**

*Commil USA, LLC v. Cisco Systems, Inc.*, 720 F.3d 1361 (Fed. Cir. 2013). In a ruling of first impression, the Federal Circuit held that an accused infringer’s good-faith belief that a patent was invalid could defeat an accusation of induced infringement. Previously, the court had ruled that a belief that the patent was not infringed was sufficient to defeat a claim of induced infringement. According to the court, “We see no principled distinction between a good-faith belief of invalidity and a good-faith belief of non-infringement for the purpose of whether a defendant possessed the specific intent to induce infringement of a patent.” Five judges dissented from the denial of the petition for rehearing en banc. According to Judge Reyna, “infringement and invalidity are separate issues under the patent code and our precedent.”

### **14. Burden of Proving Infringement in a DJ Action**

*Medtronic, Inc. v. Mirowski Family Ventures, LLC*, 134 S.Ct. 843 (2014). The U.S. Supreme Court reversed the Federal Circuit in this case, holding that the burden of proving patent infringement remains on the patent owner, even when a licensee seeks a declaratory judgment of noninfringement. According to the Supreme Court: “When a patent licensee paying royalties into an escrow account under a patent licensing agreement seeks a declaratory judgment that some of its products are not covered by or do not infringe the patent . . . the burden of persuasion is with the patentee, just as it would be had the patentee brought an infringement action.”

## **15. Patent Trolls – New Proposed Legislation, Litigation Strategies & More**

H.R. 3309 – Innovation Act (passed the House on December 5, 2013) – not yet taken up in the Senate. Seeks to curb so-called “troll abuse” by, among other things:

Section 3 -- More Detailed Pleading: Requires party alleging infringement to identify in court pleadings details about each claim allegedly infringed; each accused process, machine, manufacture or composition of matter alleged to infringe. Also requires alleged acts that give rise to indirect infringement; identify each complaint filed that alleges any of the same patents; and indicate whether a standard-setting body has declared such patent to be essential. Requires courts to award fees and expenses to the prevailing party unless position and conduct of nonprevailing party was reasonably justified or special circumstances are present. Requires court to join “interested party” if losing party alleging infringement is unable to pay. Limits discovery to information needed to determine meaning of patent claim terms.

Section 4 – Disclosure of Interested Persons: Requires plaintiffs upon filing complaint to disclose to the U.S. PTO identity of the assignee; any entity with a right to sublicense or enforce the patent; any entity that has a financial interest in the patent; and the ultimate parent entity of any assignee or entity.

Section 5 – Motion to Stay: Requires courts to grant a motion to stay action against a customer accused of infringing a patent if (1) the manufacturer is a party to the action or to a separate action involving the patent and (2) the customer agrees to be bound by any issues finally decided in the manufacturer action.

Section 6 – Judicial Conference: Directs the Judicial Conference to develop discovery rules and procedures that address categories of evidence and costs of production. Directs the Supreme Court to eliminate the model patent infringement complaint form currently provided and to provide new model allegations that are more detailed. [Note: the Judicial Conference has already proposed deleting the model patent infringement complaint form.]

Section 7 – Educational Resources: Directs the PTO to develop educational resources for small businesses to address patent infringement concerns.



Section 8 – USPTO Study: Directs the PTO to study and report to Congress regarding various aspects of U.S. patent ownership and transparency, including demand letter practices.

Section 9 – Amends the AIA: Loosens estoppel provisions for post-grant review petitioners; requires claims in post-grant and inter partes review to be interpreted the same way as in litigation (instead of currently-used broadest reasonable interpretation). Expands the scope of prior art that can be relied upon in covered business method patent proceedings.

Various Senate bills drafted having similar provisions, but none has passed. Unlikely that anything will be passed until next Congress (2015). Senator Leahy introduced S. 1720 (Patent Transparency and Improvements Act) on November 18, 2013, but pulled the bill upon determining that there was not enough support to pass it.

#### Litigation Strategies for Dealing With Patent Trolls:

A. Easier fee-shifting provisions (see *Highmark* and *Octane* cases above): Can now threaten patent trolls with motions for fees for meritless cases.

B. File an IPR or CBM Review: PTO statistics show patent challengers have high rates of success in canceling and/or narrowing claims, and district court can stay litigation pending outcome of the IPR. *Virtualagility* case encourages stays pending outcome from PTO. And, reexamination/inter partes review decisions can trump litigation (see *Fresenius* and *ePlus* cases above).

C. File an Alice motion to invalidate patents on the pleadings. Several district courts have relied on *Alice* to invalidate patents even before discovery is underway or complete.

D. File a Nautilus motion to invalidate vaguely-worded patents.

E. State Legislatures Cracking Down on Demand Letters: So far, 17 states have either passed or have pending legislation that seeks to crack down on so-called “demand letters.” The legislation varies widely, but some common elements include:

(1) Mandatory disclosures of patent number, copy of patent, interested parties, factual allegations of infringement, and pending legislation;

(2) Private right of action (Vermont): an aggrieved person may bring a lawsuit in Superior Court. Public right of action (Louisiana): attorney general may investigate and pursue violations as unfair or deceptive trade practice.

(3) Remedies: injunctions; civil penalties; costs/fees; damages; punitive damages.

**Key Take-Away:** There are new tools that can be used against so-called “patent trolls,” with more on the way at the state and federal level.



**Recent Developments in Patent Law  
(Case Law)**

**Bradley C. Wright**

**Presented to the D.C. Bar's *IP Year  
in Review Series***

**December 9, 2014**

# **RECENT DEVELOPMENTS IN PATENT LAW (CASE LAW)**

**(November 2013 to November 2014)**

**PRESENTED AT:  
THE D.C. BAR  
WASHINGTON, DC**

**DECEMBER 9, 2014**

**BRADLEY C. WRIGHT  
BANNER & WITCOFF, LTD  
1100 13<sup>TH</sup> STREET, N.W.  
WASHINGTON, D.C. 20005  
(202)-824-3160  
[bwright@bannerwitcoff.com](mailto:bwright@bannerwitcoff.com)  
[www.bannerwitcoff.com](http://www.bannerwitcoff.com)**



**BANNER & WITCOFF, LTD.  
INTELLECTUAL PROPERTY LAW**

## TABLE OF CONTENTS

A.	Patentability, Validity, and Procurement of Patents .....	2
1.	Statutory Subject Matter – Computer Software and Genes .....	2
2.	Uncorrected Patent Claim Is Unenforceable Until Corrected .....	6
3.	Indefiniteness of Patent Claims .....	7
4.	Reissue Application Cannot Be Used to Modify Terminal Disclaimer.....	9
5.	Written Description.....	9
6.	Reexamination Results Trump Litigation Validity Determination.....	10
7.	Ability to Force or Stop Inter Partes Reviews at the PTO.....	11
B.	Interpretation and Infringement of Patents.....	11
1.	Claim Construction .....	11
2.	Disclaimer of Claim Scope .....	12
3.	Induced Infringement Requires Evidence of Direct Infringement .....	13
4.	Doctrine of Equivalents – No “Foreseeability” Requirement .....	15
5.	Prosecution History Estoppel Applies to Design Patents .....	15
C.	Enforcement of Patents.....	15
1.	Standards-Essential Patents .....	15
2.	Injunctions .....	17
3.	Attorney’s Fees .....	18
4.	Induced Infringement at the ITC .....	19
5.	Infringement Damages.....	19
6.	Patent Co-Owner Can Preclude Infringement Suit.....	21
7.	Stays of Litigation Pending PTO Review of Patent .....	21
8.	Consumer Groups May Lack Standing to Attack Patents .....	22
9.	Contempt Order Not Appealable Until Sanctions Determined .....	22
10.	Declaratory Judgment Jurisdiction Where Customers Are Sued.....	23
11.	Inequitable Conduct .....	23
14.	Burden of Proving Infringement in a DJ Action.....	23
15.	Severing/Staying Infringement Suits Against Customers.....	24

## A. Patentability, Validity, and Procurement of Patents

### 1. Statutory Subject Matter – Computer Software and Genes

*Alice Corp. Pty Ltd v. CLS Bank Int'l*, 134 S.Ct. 2347 (2014), *affirming* 717 F.3d 1269 (Fed. Cir. 2013). Alice Corp. is the owner of four patents that cover a computerized trading platform for exchanging obligations in which a trusted third party settles obligations between a first and second party to eliminate settlement risk, which is the risk that only one party's obligation will be paid. Three types of patent claims were at issue: (1) method claims; (2) computer-readable media claims; and (3) system claims. The district court held that all the claims were not patent-eligible under 35 U.S.C. § 101 because they fell within the "abstract ideas" exception to patentability. A panel of the Federal Circuit initially reversed, holding that the claims were directed to practical applications of the invention falling within the categories of patent eligible subject matter. The panel stated that it must be "manifestly evident that a claim is directed to a patent ineligible abstract idea" before it will be ruled invalid. The Federal Circuit later granted a petition for rehearing en banc.

The *en banc* court (decided by 10 judges who were eligible to hear the case) reversed the panel decision and issued a total of 6 separate opinions, plus a seventh "additional views" passage by Chief Judge Rader. In a per curiam opinion, a majority of the judges agreed that the method and computer-readable media claims were invalid, but disagreed as to the reasoning. An equally divided (5-member) court affirmed the district court's decision that the system claims were also invalid. Judge Lourie (joined by 4 others) concluded that all claims were invalid because they "preempt a fundamental concept" – the "idea" of the invention is third-party mediation, and clever claim drafting cannot overcome that preemption. Judge Rader, writing for a 4-member minority, agreed that the method and computer-readable media claims were invalid because they recited an abstract concept, but would have upheld the patentability of the system claims, pointing out that a machine cannot be an "abstract idea." Judge Moore, writing for 4 judges, also pointed out that the system claims should not be considered an abstract idea. Judge Newman would have found all of the claims patent-eligible. Judges Linn and O'Malley would also have found all claims to be patent-eligible because the parties agreed that all claims required the use of a computer. Judge Rader's "additional views" lamented the lack of agreement on the issue.

The U.S. Supreme Court affirmed, concluding that all of the claims were not eligible for a patent. The Court began by reviewing the "framework" it established in *Mayo Collaborative Services v. Prometheus Laboratories*, 132 S.Ct 1289 (2012) for distinguishing patents that claim abstract ideas from those that claim patent-eligible subject matter. First, the Court determines whether the claims at issue are directed to one of those patent-ineligible concepts. If the claims are directed to a patent-ineligible concept, the Court then asks what else in the claims constitutes an

“inventive concept” – i.e., an elements or combination of elements that is “sufficient to ensure that the patent in practice amounts to significantly more than a patent upon the [ineligible concept] itself.”

In this case, the Court determined that the claims were drawn to the abstract idea of intermediated settlement. Analogizing the claims in this case to those at issue in *Bilski v. Kappos*, 561 U.S. 593 (2010), which involved a series of steps for hedging risk, the Court concluded that the claims here were directed to a method of exchanging financial obligations between two parties using a third-party intermediary to mitigate settlement risk. “On their face, the claims before us are drawn to the concept of intermediated settlement, i.e., the use of a third party to mitigate settlement risk.” The Court concluded that the use of a third-party intermediary “is also a building block of the modern economy.” (citing treatises).

Applying the second step of the *Mayo* analysis, the Court examined the claims to determine whether they contained any “inventive concept” sufficient to “transform” the claimed abstract idea into a patent-eligible application. The Court explained that the claim must be more than a “drafting effort designed to monopolize the abstract idea.” The Court also noted that “the introduction of a computer into the claims does not alter the analysis at *Mayo* step two.” Citing its earlier decisions in *Benson* and *Flook*, the Court explained that limiting the use of the idea to a particular technological environment could not circumvent the prohibition on abstract ideas. “The mere recitation of a generic computer cannot transform a patent-ineligible abstract idea into a patent-eligible invention.” As to the specific system claims that recited specific hardware elements, the Court concluded that a “data processing system,” a “communications controller,” and a “data storage unit,” were “purely functional and generic.” According to the Court, “nearly every computer will include a ‘communications controller’ and ‘data storage unit.’ As a result, none of the hardware recited by the system claims offered a “meaningful limitation” beyond generally linking the use of the method to a particular technological environment.

The Court seemingly distinguished inventions that “improve the functioning of the computer itself” and inventions that “effect an improvement in any other technology or technical field” from the holding of this case. These two factors might very well be the new “safe harbors” in claiming inventions that can otherwise be characterized as an “abstract idea.”

*In re Roslin Institute*, 750 F.3d 1333 (Fed. Cir. 2014). The Federal Circuit affirmed the U.S. PTO’s determination that claims directed to a cloned animal – “Dolly the Sheep” – were unpatentable subject matter. Relying on the recent U.S. Supreme Court’s decision in *Association for Molecular Pathology v. Myriad Genetics*, 133 S.Ct. 2107 (2013), which held that naturally-occurring organisms such as isolated genes are not patentable, the court explained that “Dolly herself is an exact genetic replica of another sheep and does not possess ‘markedly different characteristics from any [farm animals] found in nature.’” According to the court, “Dolly’s genetic identity to her donor parent renders her unpatentable.”

*Digitech Image Tech., LLC v. Electronics for Imaging, Inc.* 758 F.3d 1344 (Fed. Cir. 2014). Digitech, which owns U.S. Patent No. 6,128,415 directed to a “device profile” and a method for creating a device profile in a digital image processing system, sued 32 defendants for patent infringement. The district court granted summary judgment of invalidity of the patent in favor of the defendants, and Digitech appealed.

The structure of the claims was as follows:

1. A *device profile* for describing properties of a device in a digital image reproduction system . . . comprising:

*first data* for describing a device dependent transformation of color information content of the image . . . and

*second data* for describing a device dependent transformation of spatial information content of the image . . . .

10. A method of generating a device profile that describes properties of a device in a digital image reproduction system . . . comprising:

*generating first data* for describing a device dependent transformation of color information content of the image . . .

*generating second data* for describing a device dependent transformation of spatial information content of the image . . . and

*combining* said first and second data into the device profile.

The district court ruled that the “device profile” claims were directed merely to a collection of numerical data lacking any physical component or physical manifestation, and thus it did not fall within one of the four statutory categories of patent-eligible subject matter under 35 U.S.C. § 101. The court also ruled that the method claims were invalid because they were directed to the abstract idea of organizing data through mathematical correlations.

The Federal Circuit affirmed. As to the “device profile” claims, the Federal Circuit explained that “For all categories except process claims, the eligible subject matter must exist in some physical or tangible form” and that to qualify as a machine, the claimed invention must be “a concrete thing, consisting of parts, or of certain devices and combination of devices” (quoting *Burr v. Duryee*, 68 U.S. 531 (1863)). Because the “device profile” claims did not include anything tangible, they were not eligible for patent protection and thus the claims were invalid.

As to the method claims, the Federal Circuit cited the Supreme Court’s recent



decision in *Alice Corp. v. CLS Bank Int'l*, 134 S.Ct. 2347 (2014) (see above) for the proposition that the claims merely recited an abstract idea because they describe a process for organizing information through mathematical correlations and are not tied to a specific structure or machine. According to the court, “The above claim recites a process of taking two data sets and combining them into a single data set, the device profile.” Quoting from the Supreme Court’s 1972 decision in *Parker v. Flook*, the Federal Circuit concluded that “If a claim is directed essentially to a method of calculating, using a mathematical formula, even if the solution is for a specific purpose, the claimed method is nonstatutory.”

*Ultramercial, Inc. v. Hulu, LLC*, \_\_\_ F.3d \_\_\_, 2014 WL 5904902 (Fed. Cir. Nov. 14, 2014). In this patent-eligibility case that has made no fewer than two trips to the U.S. Supreme Court, the Federal Circuit finally struck down as unpatentable a patent directed to a method for distributing copyrighted media over the Internet where a consumer receives a copyrighted media product in exchange for viewing an advertisement. First, the court determined that the 11-step process recites an abstraction – “an idea, having no particular concrete or tangible form. The process of receiving copyrighted media, selecting an ad, offering the media in exchange for watching the selected ad . . . all describe an abstract idea, devoid of a concrete or tangible application.” Next, the court concluded that the claims did not transform the abstract idea into patent-eligible subject matter because they merely instructed the practitioner to implement the abstract idea with routine, conventional activity. Based on these conclusions, the claims were invalid.

*Planet Bingo, LLC v. VKGS LLC*, 576 Fed. Appx. 1005 (Fed. Cir. Aug. 26, 2014). Planet Bingo owns two patents for computer-aided management of bingo games. After Planet Bingo sued VKGS for patent infringement, the district court granted summary judgment of invalidity, concluding that the patents did not recite patentable subject matter. Generally speaking, the patent claims recite computer-aided methods and systems for managing a bingo game, including storing a player’s preferred sets of bingo numbers; retrieving a set upon demand, and playing that set, while simultaneously tracking the player’s sets, tracking player movements, and verifying winning numbers. Applying the Supreme Court’s *Alice* decision, the district court determined that each claim encompassed the abstract idea of managing and playing a bingo game, and that the use of a computer “adds nothing more than the ability to manage . . . Bingo more efficiently.” The court held that the system claimed a computer “only for its most basic functions,” including storing numbers, assigning identifiers, allowing for inputs and outputs, printing receipts, and matching numbers. The Federal Circuit affirmed, concluding that there was no meaningful distinction between the method and system claims, or between the independent or dependent claims. According to the Federal Circuit, the claims were “similar to the kind of ‘organizing human activity’ at issue in *Alice* . . . and similar to the abstract ideas of ‘risk hedging’ during consumer transactions” in *Bilski*. The Federal Circuit also concluded that “the function performed by the computer at each step of the process is ‘purely conventional’” and thus not patent-eligible.

*Buysafe, Inc. v. Google, Inc.*, 765 F.3d 1350 (Fed. Cir. 2014). The Federal Circuit affirmed a district court’s ruling on a motion to dismiss on the pleadings a patent directed to a method and machine-readable medium for guaranteeing a party’s performance of its online transaction. Relying on *Alice*, the Federal Circuit first found that the claims “are squarely about creating a contractual relationship – a ‘transaction performance guaranty’ that is beyond question of ancient lineage.” It then concluded that the claims’ “invocation of computers adds no inventive concept. The computer functionality is generic – indeed, quite limited: a computer receives a request for a guarantee and transmits an offer of guarantee in return.”

Note: Since the Supreme Court’s *Alice* decision, there have been at least 11 district court decisions that have invalidated patents based on the *Alice* reasoning. Examples include *Loyalty Conversion Systems Corp. v. American Airlines*, No. 2:13-cv-655 (E.D. Tex. Sept. 3, 2014) (patents to loyalty reward program ruled unpatentable); *Walker Digital v. Google, Inc.*, No. 11-318 (D. Del. Sept. 3, 2014) (patents directed to employment search system ruled unpatentable); *Tuxis Technologies, LLC v. Amazon.com, Inc.*, No. 13-1771 (D. Del. Sept. 3, 2014) (patent directed to method of “upselling” over electronic network declared invalid); and *Intellectual Ventures I LLC v. Capital One Financial Corp.*, 2014 WL 1513273 (E.D. Va. April 16, 2014) (patent directed to system allowing a consumer to establish self-imposed limits on borrowing held invalid)

**Key Take-Away:** The PTO and courts are increasingly rejecting or invalidating patents directed to various types of inventions that can be characterized as an “abstract idea,” even if the claims recite specific computer components. Inventions in certain fields, such as financial services, electronic commerce, marketing/sales programs, loyalty programs, and others may be at higher risk of vulnerability.

## **2. Uncorrected Patent Claim Is Unenforceable Until Corrected**

*H-W Technology, L.C. v. Overstock.com, Inc.*, 758 F.3d 1329 (Fed. Cir. 2014). H-W Technology sued Overstock.com for infringing a patent relating to a device and method for performing contextual searches on an IP phone. The asserted method claim as approved by the patent examiner included a specific limitation relating to the user completing a transaction with a merchant without generating a voice call. As issued, however, the printed patent omitted this limitation. H-W had asserted the uncorrected patent in its lawsuit, and the district court concluded that the claim was invalid because it did not accurately reflect what was allowed by the patent examiner. The Federal Circuit affirmed the district court’s refusal to judicially correct the patent, because the error was not “evident from the face of the patent.” Although the error was clear based on the prosecution history, that fact did not permit the court to correct the patent. The Federal Circuit also ruled that the district court properly refused to consider the later-filed certificate of correction, because of prior precedent concluding that such certificates are effective only for causes of action arising after the certificate was issued. Because H-W filed this lawsuit before the certificate of correction was issued, the patent was held to be unenforceable

before its correction.

### 3. Indefiniteness of Patent Claims

*Nautilus, Inc. v. Biosig Instruments, Inc.*, 134 S.Ct. 2120 (2014). Biosig’s patent relates to a heart-rate monitor used with exercise equipment in a way that filters out electrical interference, allowing for more accurate measurements. The claim recites a cylindrical bar that a user grips with both hands, each hand contacting a pair of electrodes and a display device, wherein the pairs of electrodes are “mounted . . . in spaced relationship with each other:”

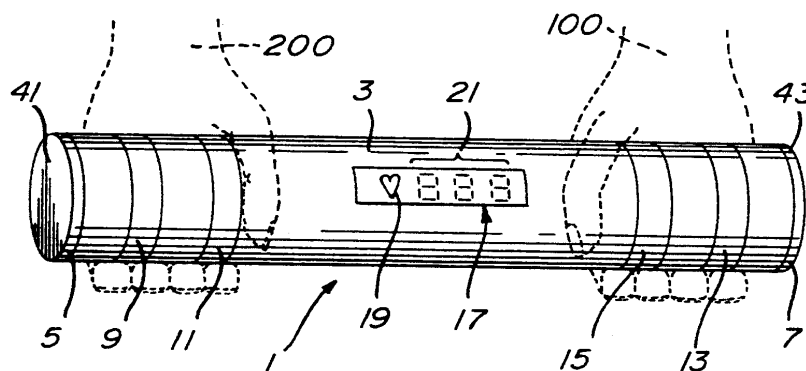

Biosig sued Nautilus for infringing the patent. While the suit was pending, Nautilus convinced the U.S. PTO to reexamine the patent based on prior art. During the reexamination proceedings, Biosig submitted a declaration by the inventor stating that the patent sufficiently informed a person skill in the art how to configure the electrodes so as to produce equal EMG signals from the left and right hands. Although the spacing of the electrodes could not be standardized across all types of exercise machines, the inventor explained that a person skilled in the art could use “trial and error” to determine the correct equalization. Thereafter, the PTO issued a reexamination certificate confirming the patentability of the claims.

Biosig asserted that the “spaced relationship” limitation referred to the distance between the two electrodes. Nautilus argued that the “spaced relationship” required that the distance be greater than the width of each electrode. The district court interpreted the term to mean that there is a “defined relationship” between the two electrodes on each side of the bar, without any particular width requirement. Nautilus then moved for summary judgment, arguing that the term “spaced relationship” was indefinite because it failed to adequately inform those skilled in the art as to the boundaries of the claims. The district court granted the motion, concluding that the term failed to inform anyone what precisely the space should be, or even supply any parameters for determining the appropriate spacing.

The Federal Circuit, applying its case law imposing a high bar to proving

indefiniteness of a patent claim – requiring that a claim be “insolubly ambiguous” in order for it to be invalid – reversed. According to the Federal Circuit, the patent discerned “certain inherent parameters” that allowed a person to understand the metes and bounds of “spaced relationship.” That required that the distance be no greater than the width of a user’s hand, and no less than an “infinitesimally small” distance.

The U.S. Supreme Court vacated and remanded for further proceedings. Justice Ginsburg’s opinion began by explaining that patent claims are directed to those skilled in the relevant art. Patent claims must be precise enough to apprise the public of what is still open to them, otherwise a “zone of uncertainty” would exist that would deter others from knowing their risk of infringement. The Court announced that the correct test for definiteness requires that “a patent’s claims, viewed in light of the specification and prosecution history, inform those skilled in the art about the scope of the invention with reasonable certainty.” It rejected the Federal Circuit’s “insolubly ambiguous” test for measuring claim definiteness and remanded for reconsideration under the correct standard.

*Triton Tech of Texas, LLC v. Nintendo of America*, 753 F.3d 1375 (Fed. Cir. 2014). Triton Tech sued Nintendo, alleging that the Wii Remote used in combination with a related accessory infringed a patent directed to an input device for a computer. The district court ruled that the patent claims were invalid because the recited “integrator means associated with said input device for integrating said acceleration signals over time” had no corresponding algorithm disclosed in the specification. Triton Tech argued that the structure corresponding to the “integrator means” was a conventional microprocessor, and that the term “numerical integration” was sufficient disclosure of the algorithm because numerical integration was well-known to those of skill in the art. The Federal Circuit, however, affirmed the district court’s finding that “numerical integration” was not an algorithm but was instead an entire class of different possible algorithms used to perform integration. Accordingly, the patent claims were affirmed as being invalid for indefiniteness.

*In re Packard*, 751 F.3d 1307 (Fed. Cir. 2014). “This case raises an important question: what standard for indefiniteness should the U.S. Patent and Trademark Office (‘USPTO’) apply to pre-issuance claims?” The Federal Circuit answered its own question with the following standard: “when the USPTO has initially issued a well-grounded rejection that identifies ways in which language in a claim is ambiguous, vague, incoherent, opaque, or otherwise unclear in describing and defining the claimed invention, and thereafter the applicant fails to provide a satisfactory response, the USPTO can properly reject the claim as failing to meet the statutory requirements of § 112(b).” The court rejected the patent applicant’s argument that the definiteness of the claims should be measured under the Federal Circuit’s “insolubly ambiguous” standard for definiteness that has been applied in district court litigation. In this case, the court affirmed the USPTO’s rejection of claims drawn to a coin change holder, noting that the patent examiner had set forth a variety of ways in which he found the claims imprecise or confusing, sometimes not

even understandable, considering them in light of the written description.

*Interval Licensing LLC v. AOL, Inc.*, 766 F.3d 1364 (Fed. Cir. 2014). In this post-*Nautilus* case, the Federal Circuit held that patent claims reciting “in an unobtrusive manner that does not distract a user of the display device” were invalid as indefinite.

According to the court, “unobtrusive manner is highly subjective and, on its face, provides little guidance to one of skill in the art.” The court explained that a term of degree fails to provide sufficient notice of its scope of it depends “on the unpredictable vagaries of any one person’s opinion.”

**Key Take-Away:** Both the courts and the PTO are paying closer attention to clarity in patent claims, and rebuking attempts to assert vaguely-worded patents. Reliance on means-plus-function claiming techniques remains increasingly risky.

#### **4. Reissue Application Cannot Be Used to Modify Terminal Disclaimer**

*In re Dinsmore*, 757 F.3d 1343 (Fed. Cir. 2014). The Federal Circuit upheld the PTO’s determination that a patent applicant cannot use a reissue proceeding to modify a terminal disclaimer. The terminal disclaimer had been filed against another patent that was not commonly owned. According to the Federal Circuit, “applicants are ultimately seeking simply to revise a choice they made, not to remedy the result of a mistaken belief. There is not an error remediable under the reissue statute.”

#### **5. Written Description**

*Scriptpro, LLC v. Innovation Assocs, Inc.*, 762 F.3d 1355 (Fed. Cir. 2014). A district court ruled that a patent covering a machine for dispensing prescriptions was invalid because the patent specification did not adequately describe the invention as claimed.

The district court’s ruling was based on the fact that the specification described the invention as containing sensors, whereas the claims covered a machine that did not require any sensors. The Federal Circuit reversed, concluding that although the specification contained several references to “the invention” as “broadly comprises” several components including sensors, such language was not sufficiently absolute to restrict the invention to the use of sensors. According to the Federal Circuit, “We conclude that the ‘broadly includes’/‘broadly comprises’ phrases are less than a clear statement of limitation that a skilled artisan, if being reasonable, would have to read as requiring the slot sensors at issue.” Other parts of the specification referred to functionality of the sensors as providing optional, not necessary, features to the claimed invention. The court also noted that the patent was filed with original claims that did not require sensors, suggesting that the invention was not intended to be so limited.

*AbbVie Deutschland GmbH & Co. v. Janssen Biotech, Inc.*, 759 F.3d 1285 (Fed. Cir. 2014). The Federal Circuit held that patent claims directed to a set of human antibodies defined functionally by their affinity and neutralizing activity were invalid for lack of written description. According to the court, “Functionally defined genus

claims can be inherently vulnerable to invalidity challenge for lack of written description support, especially in technology fields that are highly unpredictable, where it is difficult to establish a correlation between structure and function for the whole genus or to predict what would be covered by the functionally claimed genus.”

*Elcommerce.com, Inc. v. SAP AG*, 745 F.3d 490 (Fed. Cir. 2014). A split panel of the Federal Circuit held that patent claims were erroneously invalidated on the grounds that the specification failed to adequately disclose corresponding structure for the recited means-plus-function limitations. According to the majority, the burden was on the patent challenger to submit evidence (in the form of expert declarations, for example) that the patent specification failed to disclose structure corresponding to the recited means-plus-function clauses. “Instead of evidence, SAP submitted only attorney argument.” Judge Wallach dissented, arguing that the patent specification disclosed no algorithm corresponding to the recited features, and “expert testimony is neither required nor permitted to supply the absent structures.”

## **6. Reexamination Results Trump Litigation Validity Determination**

*ePlus, Inc. v. Lawson Software, Inc.*, 760 F.3d 1350 (Fed. Cir. 2014). ePlus sued Lawson for infringing a patent relating to a method for using electronic databases to search for products. A jury concluded that Lawson infringed the claims, and the district court entered a permanent injunction against Lawson, enjoining Lawson from making or selling any products that infringed the patent. On appeal, the Federal Circuit overturned some but not all of the infringement rulings, leaving one infringement verdict in place, and remanding to the district court to modify the injunction. The district court also found that Lawson’s redesigned products were not colorably different from its earlier products found to infringe, and found Lawson to be in contempt for violating that injunction. The court ordered Lawson to pay \$18 million for the violation, plus \$62,362 daily until it could show compliance with the injunction. Lawson appealed to the Federal Circuit. Meanwhile while Lawson’s appeals were pending, the Federal Circuit affirmed the PTO’s reexamination decision that invalidated the only claim at issue in the case. Following issuance of the Federal Circuit’s mandate, the PTO canceled the claims in April 2014.

The Federal Circuit held, based on an 1851 Supreme Court decision not involving patents, that the district court’s injunction must be set aside because the PTO had canceled the patent claim on which it was based. In other words, the PTO’s cancellation of the patent claim at issue trumped the injunction issued by the district court. The Federal Circuit also set aside the district court’s award of civil contempt damages. Judge O’Malley agreed that the injunction must be set aside, but dissented from the court’s decision to set aside the civil contempt damages based on the later-vacated injunction.

**Key Take-Away:** Validity battles over patents are shifting to the U.S. PTO, which has increased power and authority to invalidate patents under the AIA. If a defendant can get patent litigation stayed pending outcome of proceedings at the

PTO, it is likely that a patent invalidated by the PTO will result in nullification of the infringement litigation.

## 7. Ability to Force or Stop Inter Partes Reviews at the PTO

*St. Jude Medical, Cardiology Division, Inc. v. Volcano Corp.*, 749 F.3d 1373 (Fed. Cir. 2014). St. Jude petitioned the PTO to institute an *inter partes* review of a patent. The PTO denied the petition, and St. Jude appealed the denial to the Federal Circuit. In an issue of first impression, the Federal Circuit concluded that 35 U.S.C. § 314(d), which states that “The determination by the Director whether to institute an *inter partes* review under this section shall be final and nonappealable,” precluded St. Jude from appealing the non-institution decision. The court further stated that “That declaration [in the statute] may well preclude all review by any route, which we need not decide.”

*In re Dominion Dealer Solutions, LLC*, 749 F.3d 1379 (Fed. Cir. 2014). Dominion Dealer petitioned the PTO to institute *inter partes* review of various patents owned by Autoalert. After the PTO denied the petitions, Dominion Dealer petitioned the Federal Circuit for a writ of mandamus directing the PTO to grant the petitions. The Federal Circuit concluded that the patent statute precludes appeal of a non-institution decision to the Federal Circuit, and therefore Dominion could not establish a “clear and indisputable” right to relief by way of writ of mandamus.

*In re The Proctor & Gamble Co.*, 749 F.3d 1376 (Fed. Cir. 2014). Proctor & Gamble owns 3 patents for whitening teeth, and Clio USA petitioned the PTO to institute *inter partes* review of the patents. The PTO granted the petitions, and P&G petitioned the Federal Circuit to issue a writ of mandamus directing the PTO to withdraw the orders instituting *inter partes* review on the grounds that Clio’s earlier declaratory judgment actions on the patents should have barred the institution of *inter partes* review under 35 U.S.C. § 315(a)(1). The Federal Circuit denied the petition on the grounds that the statute precludes an appeal from the decision to institute *inter partes* review, and “P&G’s mandamus petition is not a proper vehicle for challenging the institution of *inter partes* review.”

## B. Interpretation and Infringement of Patents

### 1. Claim Construction

*Lighting Ballast Control LLC v. Philips Electronics North America Corp.*, 744 F.3d 1272 (Fed. Cir. 2014) (en banc). The Federal Circuit issued an en banc decision affirming that claim interpretation is an issue that is to be reviewed *de novo* on appeal, rejecting arguments that its decision in *Cybor Corp. v. FAS Technologies, Inc.*, 138 F.3d 1448 (Fed. Cir. 1998) be overturned. Four judges dissented. Note: The U.S. Supreme Court on March 31, 2014 granted certiorari in *Teva Pharmaceuticals USA v. Sandoz Inc.*, Supreme Court No. 13-854, which raises the same issue.

*In re Giannelli*, 739 F.3d 1375 (Fed. Cir. 2014). In an appeal from the U.S. PTO’s Patent Trial and Appeal Board (PTAB) which affirmed a patent examiner’s rejection of claims directed to a rowing machine as obvious over a chest press exercise machine. At issue was the meaning of the claim phrase “first handle portion *adapted to be moved* from a first position to a second position by a pulling force . . . in a rowing motion.” The PTAB interpreted this language to be merely an intended use for the claimed machine, and held that the chest press machine could be used in the manner claimed. The Federal Circuit reversed, explaining that “the phrase ‘adapted to’ is frequently used to mean ‘made to,’ ‘designed to,’ or ‘configured to’ . . . . Although the phrase can also mean ‘capable of’ or ‘suitable for,’ here the written description makes clear that ‘adapted to’ . . . has a narrower meaning, viz., that the claimed machine is designed or constructed to be used as a rowing machine whereby a pulling force is exerted on the handles.” The Federal Circuit concluded that “there is no question that the ‘447 patent does not have handles that are adapted to be pulled in a rowing motion.” **Note:** This case may be helpful to rebut recent U.S. PTO patent examiners and PTAB decisions that dismiss “configured to” or “adapted to” language in patent claims as having “no patentable weight.”

*EnOcean GmbH v. Face Int’l Corp.*, 742 F.3d 955 (Fed. Cir. 2014). The Federal Circuit reversed the PTO’s determination that claims reciting “a signal *receiver for receiving* a first electromagnetic signal” and “a *receiver adapted to receiving*” should be interpreted to be means-plus-function clauses. According to the Federal Circuit, the term “receiver” “presumptively connotes sufficiently definite structure to those of skill in the art” (citing *Personalized Media Communications v. Int’l Trade Comm’n*, 161 F.3d 696, 703-04 (Fed. Cir. 1998)). The Federal Circuit also explained that merely because the disputed term is not limited to a single structure does not disqualify it as a corresponding structure, as long as the class of structures is identifiable by a person of ordinary skill in the art. The court also concluded that the mere mention of a “receiver” in the priority document provided sufficient support for the later-claimed “receiver.” “Since the inventors did not invent the receiver, and the Board found that the structure was well known as of the filing date, the inventors were not obliged . . . to describe . . . the particular appendage to which the improvement refers, nor its mode of connection with the principal machine.”

*Williamson v. Citrix Online, LLC*, 770 F.3d 1371, 2014 WL 5649886 (Fed. Cir. Nov. 5, 2014). The Federal Circuit held that the claimed recitation “distributed learning control module for receiving communications” was not a means-plus-function limitation. Instead, reaching for dictionaries that neither party had introduced into evidence, the Federal Circuit held that the term “module” “has understood dictionary meanings as connoting either hardware or software structure to those skilled in the computer arts.”

## 2. **Disclaimer of Claim Scope**

*Golden Bridge Technology, Inc. v. Apple Inc.*, 758 F.3d 1362 (Fed. Cir. 2014).



Golden Bridge sued Apple for infringing patents relating to a communication system. Golden Bridge had previously asserted one of the patents against another defendant, and the parties in that earlier litigation had stipulated to the meaning of certain claim terminology (the meaning of the word “preamble”). While an appeal from that earlier litigation was pending, Golden Bridge had also filed a continuation application and defended a reexamination of the asserted patent in the U.S. PTO. In both the continuation application and the reexamination, Golden Bridge submitted an Information Disclosure Statement (IDS) that included the claim construction order from the earlier litigation including the stipulated definition of the claim term “preamble.” In this lawsuit, the district court relied on the claim term definition contained in the IDS and granted summary judgment in favor of Apple. The Federal Circuit affirmed, concluding that Golden Bridge’s submissions “during prosecution of its stipulated construction for the term preamble constitute disclaimer. Although we generally construed terms according to their plain and ordinary meanings to one of ordinary skill in the art, we depart from that meaning where there is disclaimer.” According to the court, “it would have been natural for both the PTO and the public to rely upon the stipulation in determining the scope of the claimed invention.”

*X2Y Attenuators, LLC v. International Trade Comm’n*, 757 F.3d 1358 (Fed. Cir. 2014). The Federal Circuit held that a patent owner disavowed claim scope because the patent specification referred to a feature as “universal to all the embodiments” and as “an essential element among all embodiments or connotations of the invention.” Even though some of the statements were contained in priority documents, those priority documents were incorporated by reference into the patent, and thus the incorporated patents were “effectively part of the host [patents] as if [they] were explicitly contained therein.”

### **3. Induced Infringement Requires Evidence of Direct Infringement**

*Limelight Networks, Inc. v. Akamai Technologies*, 134 S.Ct. 2111 (2014). M.I.T. owns a patent that claims a method of delivering electronic data using a content delivery network. Akamai, the exclusive licensee of the patent, contracts with website owners to improve content delivery by designating certain components of the web site to be stored on Akamai’s servers in a process known as “tagging.” By serving the content from different servers, Akamai is able to increase the speed with which Internet users access the content on the websites. Limelight networks also carries out several steps of the patented method, but instead of tagging those components of the websites that are stored on its servers as claimed, Limelight requires its customers to do their own “tagging.”

In 2006, Akamai sued Limelight for patent infringement, and a jury awarded \$40 million in damages. After the jury verdict, the Federal Circuit decided another case, *Muniauction, Inc. v. Thomson Corp.*, 532 F.3d 1318 (Fed. Cir. 2008), which held that a party could only be liable for infringement if a single entity performed all of the claimed method steps, or if a single defendant “exercises control or direction” over the entire process such that every step is attributable to the controlling party.

Because the defendant in *Muniauction* did not exercise control or direction over its customers' performance of the steps, no infringement could be found. In light of *Muniauction*, the district court granted Limelight's motion to set aside the verdict on the basis that no direct infringement existed, and because Limelight did not control or direct its customer's "tagging" operation, no infringement could be found.

The Federal Circuit initially affirmed, concluding that a defendant that does not itself perform all of the steps of a patented method can be eligible for direct infringement only "when there is an agency relationship between the parties who perform the method steps or when one party is contractually obligated to the other to perform the steps." Because Limelight did not have control over its customers, the customer's tagging operations could not be attributed to Limelight.

The Federal Circuit reheard the *Limelight* case en banc and reversed. The en banc court did not revisit its direct infringement case law, but instead concluded that "the evidence could support a judgment in Akamai's favor on a theory of induced infringement" under 35 U.S.C. § 271(b). This was true, according to the Federal Circuit, because liability for induced infringement arises when a defendant carries out some steps constituting a method patent and encourages others to carry out the remaining steps, even if no one would be liable as a direct infringer.

The Supreme Court reversed and remanded, beginning with the proposition that there can be no liability for induced infringement unless there is direct infringement. Justice Alito blasted the Federal Circuit, stating that "The Federal Circuit's analysis fundamentally misunderstands what it means to infringe a method patent. A method patent claims a number of steps; under this Court's case law, the patent is not infringed unless all the steps are carried out." The Court explained that "where there has been no direct infringement, there can be no inducement of infringement under § 271(b)." The Court rejected the analogy that tort law imposes liability on a defendant who harms another through a third party, even if that third party would not himself be liable. "Because Limelight did not undertake all steps of the '703 patent and cannot otherwise be held responsible for all those steps, respondents' rights have not been violated." The Court also rejected an analogy to the federal aiding and abetting statute. The Court did, however, acknowledge the danger in permitting a would-be infringer to evade liability by dividing performance of a method claim with another whom the defendant neither directs nor controls, but noted that such an anomaly "would result from the Federal Circuit's interpretation of § 271(a) in *Muniauction*," suggesting that the holding in that case was questionable. The Court also rejected Akamai's suggestion that the Supreme Court review the Federal Circuit's earlier *Muniauction* decision, stating that "we decline to do so today." The case was remanded to the Federal Circuit with the caveat that "the Federal Circuit will have the opportunity to revisit the § 271(a) question if it so chooses."

**Key Take-Away:** The importance of careful claim drafting, particularly when drafting method claims involving computer technology, cannot be overemphasized. Claims that involve participation by more than one person or corporate entity may be

difficult to enforce in court, leaving patent owners with little or no recourse.

#### **4. Doctrine of Equivalents – No “Foreseeability” Requirement**

*Ring & Pinion Service Inc. v. ARB Corp.*, 743 F.3d 831 (Fed. Cir. 2014). A district court granted summary judgment of non-infringement for a patent directed to a locking differential for an automobile. The Federal Circuit reversed, concluding that the district court erroneously held that the patent owner was precluded from asserting equivalence under the doctrine equivalents because the accused structure would have been foreseeable at the time the patent application was filed. The Federal Circuit explained that, “There is not, nor has there ever been, a foreseeability limitation on the application of the doctrine of equivalents. It has long been clear that known interchangeability weighs in favor of finding infringement under the doctrine of equivalents.” The court also made clear that equivalents for purposes of the doctrine of equivalents is measured as of the time of infringement, not the time the patent application was filed – except when assessing equivalency of structure for purposes of literal infringement under 35 U.S.C. § 112(f) (formerly 35 U.S.C. § 112, sixth paragraph).

#### **5. Prosecution History Estoppel Applies to Design Patents**

*Pacific Coast Marine Windshields Ltd v. Malibu Boats, LLC*, 739 F.3d 694 (Fed. Cir. 2014). In an issue of first impression, the Federal Circuit held that the doctrine of prosecution history estoppel applies to design patents. In this case, the patent applicant filed a design patent application claiming an ornamental design for a marine windshield with a frame, a tapered corner post with vent holes and without vent holes, and with a hatch and without a hatch. The patent examiner issued a restriction requirement, identifying 5 different designs. The applicant selected the first group, corresponding to a windshield having four vent holes and a hatch and canceled the figures corresponding to the non-elected group. After the patent issued, the patent owner sued Malibu Boats for infringement based on an accused windshield having only three vent holes. The Federal Circuit affirmed the district court’s grant of summary judgment of non-infringement, concluding that cancellation of figures and striking references to alternative embodiments constituted a surrender of claim scope. It rejected the argument that estoppel was limited to amendments made to avoid prior art.

### **C. Enforcement of Patents**

#### **1. Standards-Essential Patents**

*Apple Inc. v. Motorola, Inc.*, 757 F.3d 1286 (Fed. Cir. 2014). In a patent infringement suit brought by Apple against Motorola, Motorola counterclaimed for

infringement of a patents that was deemed essential to a standard. The district court granted Apple’s motion for summary judgment that Motorola was not entitled to an injunction on the standard-essential patent, because Motorola had agreed to license it on fair, reasonable, and nondiscriminatory (“FRAND”) terms. The Federal Circuit stated that “to the extent the district court applied a *per se* rule that injunctions are unavailable for SEPs [standard-essential patents], it erred. While Motorola’s FRAND commitments are certainly criteria relevant to its entitlement to an injunction, we see no reason to create, as some *amici* urge, a separate rule or analytical framework for addressing injunctions for FRAND-committed patents.” Instead, the court explained that the framework set forth by the Supreme Court in its 2006 *eBay v. MercExchange* case should govern whether an injunction is issued. For example, the Federal Circuit noted that an injunction might be warranted where an infringer refuses a FRAND royalty or unreasonably delays negotiations to the same effect. In this case, however, the Federal Circuit affirmed the summary judgment that no injunction should issue, because Motorola had failed to establish irreparable harm. “Considering the large number of industry participants that are already using the system claimed in the ‘878 patent, including competitors, Motorola has not provided any evidence that adding one more user would create such harm.”

*Commonwealth Scientific and Industrial Research Organization v. Cisco Systems, Inc.*, 2014 WL 3805817 (E.D. Tex. July 23, 2014). Commonwealth Scientific (CSIRO) owns a patent that is essential to practicing a standard-essential invention relating to Wi-Fi. The IEEE adopted the standard, and Cisco agreed to a bench trial on the amount of damages it must pay for using the standard. The district court rejected CSIRO’s damages model as flawed, concluding that its \$30 million theory was based on an expert who had wide variability in estimated profit premiums attributable to the patented technology. The court also found that the expert’s “drastic final apportionment is arbitrary, capricious, and supported by no sound economic methodology.” The court similarly rejected Cisco’s total damages theory of \$1.1 million, because it was based primarily on the prices of chips that implemented various features of the patented invention, rather than the combination of techniques including other components. Relying on the so-called “hypothetical negotiation” between the parties, the district court ultimately focused on an informal offer of \$0.90 per product that Cisco had made to CSIRO even though the offer was made years after the so-called hypothetical negotiation would have taken place. Based on this offer, the district court concluded that a range of \$0.90 to \$1.90 was appropriate (the upper bound set by CSIRO’s “voluntary” licensing program to others), and ultimately awarded total damages in the amount of \$16 million.

*Realtek Semiconductor Corp. v. LSI Corp.*, 2014 WL 2738226 (N.D. Cal. June 16, 2014). LSI Corp owns two patents that it states are “essential” to the 802.11 WiFi standard, and its predecessor (Agere) submitted Letters of Assurance (LOA) to the IEEE stating that it was prepared to grant licenses on a FRAND basis (fair, reasonable, and non-discriminatory). Agere contacted Realtek to offer a license under the patents at a rate of 5%, but Realtek did not respond. Years later, after LSI acquired Agere, LSI sent a letter to Realtek demanding that it cease and desist from

infringing the patents. Less than a week later, LSI filed a complaint in the ITC, seeking to block Realtek products from being imported into the U.S. A month later, Realtek sent a letter to LSI, requesting that it make the patents available under FRAND license terms. LSI responded with an offer letter that applied a royalty rate to the total value of the end product rather than to the value of the components that Realtek supplied. Realtek then sued LSI, asserting that LSI breached its FRAND licensing obligations, and Realtek moved for partially summary judgment. The district court granted the motion, concluding that Agere's LOA letter to the IEEE constituted a binding contract to license their patents, and that filing an ITC action before offering a RAND license constituted a breach of that agreement.

Beginning in February 2014, the court held a jury trial to determine Realtek's breach of contract damages and the RAND rates for the two patents. The jury awarded \$3.8 million to Realtek for breaching of contract and found RAND royalty rates of 0.12% for one patent and 0.07% for the other patent. Realtek then moved for a permanent injunction enjoining LSI from further demanding royalties beyond the jury's verdict and from seeking to enforce any patents in the ITC without first offering Realtek a license. The court denied the injunction because the ITC had ruled that LSI failed to prove infringement, and thus there was no irreparable harm. The court did, however, grant Realtek's request for declaratory relief, ruling that upon Realtek's request for a license, to be in compliance with its RAND obligations, LSI must offer Realtek a license to the patents at the rates found by the jury.

## **2. Injunctions**

*Apple Inc. v. Samsung Electronics Co.*, 735 F.3d 1352 (Fed. Cir. 2013). Apple sued Samsung for infringing various patents relating to smartphones. A jury found that various Samsung smartphones infringed six of Apple's patents (three design patents and three utility patents), and awarded Apple more than \$1 billion in damages. The patents relate generally to the ornamental appearance of the rounded phone, and various touch-screen features such as a "pinch-to-zoom" feature. After trial, Apple moved for a permanent injunction, but the district court denied the motion. On appeal, the Federal Circuit affirmed the denial of the permanent injunction as to the design patents, agreeing with Samsung that Apple had failed to show irreparable harm from the infringement because it did not establish a sufficient "causal nexus" between the harm and Samsung's patent infringement. Apple had failed to submit sufficient evidence that consumers were buying Samsung's products because of the features claimed in the design patents.

As to Apple's utility patents, however, the Federal Circuit held that the district court erroneously rejected Apple's survey evidence showing that consumers were willing to pay a premium for the features claimed in those patents. As to the inadequacy of legal damages to compensate for infringement, the Federal Circuit agreed that Apple's past agreements to license the patents was relevant, but faulted the district court for placing too much weight on Apple's previous licenses, some of which were entered into in settlement of litigation. As to the public interest factor, the Federal

Circuit agreed with the district court's conclusion that an injunction would prevent the public from enjoying a wide range of non-infringing features based on "limited non-core functions."

*Trebro Mfg. v. Firefly Equipment, LLC*, 748 F.3d 1159 (Fed. Cir. 2014). The Federal Circuit reversed a district court's refusal to grant a preliminary injunction to a patent owner that did not itself practice the patented invention. According to the Federal Circuit, "the fact that Trebro does not presently practice the patent does not detract from its likely irreparable harm . . . . Trebro and FireFly are direct competitors selling competing products in the market. Thus, the record strongly shows a probability for irreparable harm." The court also quoted approvingly from an earlier case: "a patentee's failure to practice an invention does not necessarily defeat the patentee's claim of irreparable harm."

### **3. Attorney's Fees**

*Octane Fitness, LLC v. ICON Health & Fitness, Inc.*, 134 S.Ct. 1749 (2014). Section 285 of the patent statute permits a district court to award attorney's fees "in exceptional cases . . . to the prevailing party." Existing Federal Circuit case law held that a case could be held "exceptional" in only two situations: (1) when there has been some material inappropriate conduct, or (2) when the litigation is both "brought in subjective bad faith" and is "objectively baseless." In this case, ICON sued Octane for infringing several claims of a patent relating to exercise equipment. The district court granted Octane's motion for summary judgment, concluding that the patent was not infringed. Octane moved for attorney's fees, but the district court denied the motion because Octane did not show that the suit was "objectively baseless" or that ICON had brought it in subjective bad faith. The Federal Circuit affirmed, but the Supreme Court granted certiorari, reversed and remanded.

The Supreme Court began with reference to dictionary definitions of the word "exceptional" from the 1930s, which were in use at the time Congress enacted the 1952 Patent Act. In that context, the word meant "out of the ordinary course," "unusual," or "special." "We hold, then, that an 'exceptional' case is simply one that stands out from others with respect to the substantive strength of a party's litigating position (considering both the governing law and the facts of the case) or the unreasonable manner in which the case was litigated. District courts may determine whether a case is 'exceptional' in the case-by-case exercise of their discretion, considering the totality of the circumstances."

The Supreme Court rejected the Federal Circuit's "rigid and mechanical" formulation established in *Brooks Furniture Mfg, Inc. v. Dutilier Int'l, Inc.*, 393 F.3d 1378 (Fed. Cir. 2005), noting that its standard was nearly the same as that for "sanctionable conduct" under Federal Rule of Civil Procedure Rule 11. Instead, "a district court may award fees in the rare case in which a party's unreasonable conduct – while not necessarily independently sanctionable – is nonetheless so 'exceptional' as to justify an award of fees. Finally, "we reject the Federal Circuit's

requirement that patent litigants establish their entitlement to fees under § 285 by ‘clear and convincing evidence.’” Instead, such entitlement should be based on a preponderance of the evidence standard.

*Highmark Inc. v. Allcare Health Mgt System, Inc.*, 134 S.Ct 1744 (2014). The patent statute provides that a court in exceptional cases may award reasonable attorney fees to the prevailing party. Highmark sued Allcare seeking a declaratory judgment that its patent was invalid, unenforceable, and not infringed. The district court entered a final judgment of noninfringement in favor of Highmark and the Federal Circuit affirmed. Highmark then moved for attorney fees, which the district court granted based on Allcare’s pattern of “vexatious” and “deceitful” conduct throughout the litigation. Among other things, the court found that Allcare had maintained infringement claims against Highmark well after such claims had been shown by its own experts to be without merit, and asserted frivolous defenses. The Federal Circuit reversed in part, reviewing *de novo* the exceptional-case determination. Relying in part on its *Octane Fitness* decision (discussed above), the U.S. Supreme Court vacated and remanded, concluding that “an appellate court should apply an abuse-of-discretion standard in reviewing all aspects of a district court’s § 285 determination.”

**Key Take-Away:** It will be increasingly easier to get attorney’s fees for meritless patent cases, which might discourage so-called “patent trolls” in the coming months and years. Time will tell how far courts are willing to go in making such awards.

#### **4. Induced Infringement at the ITC**

*Suprema, Inc. v. International Trade Commission*, 742 F.3d 1350 (Fed. Cir. Dec. 13, 2013), *vacated and rehearing en banc granted*, 2014 WL 3036241 (May 13, 2014). In an issue of first impression, the Federal Circuit held that the ITC may not issue an exclusion order barring importation of products that infringe only under a theory of induced infringement, where no direct infringement occurs until after importation of the articles the exclusion order would bar. In this case, the direct infringement did not occur until after Mentalix combined Suprema’s products with its own software, thus making Suprema allegedly liable for induced infringement. The Federal Circuit based its decision on the language of the ITC statute (section 337), which refers to importation of “articles that . . . infringe a valid and enforceable United States patent.”

#### **5. Infringement Damages**

*Apple Inc. v. Motorola, Inc.*, 757 F.3d 1286 (Fed. Cir. 2014). Apple sued Motorola for infringing 3 patents relating to various features of smartphones. The district court (Circuit Judge Posner sitting by designation) excluded Apple’s damages expert from testifying regarding damages because that expert relied upon a technical expert to identify a potential design-around option that could have avoided infringement, and relied on the existence of that design-around option for his damages assessment.

According to the Federal Circuit, “The district court’s decision states a rule that neither exists nor is correct. Experts routinely rely upon other experts hired by the party they represent for expertise outside of their field.” The court noted that patent damages experts often rely on technical expertise outside of their field when evaluating design-around options or valuing the importance of the specific infringing features in a complex device. The Federal Circuit also rejected the district court’s concerns that the technical expert who was hired by Apple could have been biased. According to the Federal Circuit, “this concern is addressed by the weight given to the expert’s testimony, not its admissibility.” The Federal Circuit also rejected the district court’s conclusion that Apple was not entitled to any damages because of its purported lack of admissible evidence, noting that the patent statute provides that the court must award damages “in no event less than a reasonable royalty.” The court stated that “If a patentee’s evidence fails to support its specific royalty estimate, the fact finder is still required to determine what royalty is supported by the record.”

*VirnetX, Inc. v. Cisco Systems, Inc.*, 767 F.3d 1308 (Fed. Cir. 2014). In this important damages case, the Federal Circuit again cut back on a large (\$368 million) jury award, concluding that it was not supported by a legally sustainable theory. VirnetX’s damages expert, Mr. Weinstein, provided three different reasonable royalty theories, which the district court admitted and the jury heard. First, Weinstein applied a 1% royalty rate to the base sale price of each device accused of infringement, based on VirnetX’s policy of seeking a 1% to 2% license based on the entire value of products sold and several allegedly comparable licenses, resulting in a \$708 million demand. Second, Weinstein relied on the so-called “Nash Bargaining Solution,” which assumed that the parties would have split between themselves the incremental profits attributable to the use of the patented technology, leading to \$588 million in damages. Third, Weinstein again relied on the Nash Bargaining solution, concluding partly on the basis of a customer survey that 18% of all iOS device sales would not have occurred without the allegedly infringing feature, leading to damages of \$606 million.

As to Weinstein’s first theory, the Federal Circuit held that when claims are drawn to an individual component of a multi-component product, damages may only rarely be based on the value of the multi-component product. “A patentee may assess damages based on the entire market value of the accused product only where the patented feature creates the basis for customer demand or substantially creates the value of the component parts.” According to the Federal Circuit, the district court erroneously instructed the jury that it could apply the entire market value rule as long as the product in question constituted “the smallest saleable unit containing the patented feature.” Here, “the instruction mistakenly suggests that when the smallest saleable unit is used as the royalty base, there is necessarily no further constraint on the selection of the [royalty] base.” According to the court, “Where the smallest saleable unit is, in fact, a multi-component product containing several non-infringing features with no relation to the patented feature (as VirnetX claims it was here), the patentee must do more to estimate what portion of the value of that product is attributable to the patented technology.” Because Weinstein based his calculations



on the entire cost of each Apple device, ranging in value from \$199 for the iPod Touch to \$649 for the iPhone 4S, he failed to properly subtract any other unpatented elements from the base, which therefore included various features not covered by the patents, such as touch-screen, camera, processor, speaker, and microphone.

As to Weinstein's second and third theories, which relied on the so-called Nash Bargaining Theory, the Federal Circuit squarely rejected that as a basis for calculating damages. Like the previous "25% rule of thumb" starting point for determining a reasonable royalty in patent infringement damages, "the use here was just such an inappropriate 'rule of thumb.'" According to the Federal Circuit, "while we comment parties for using a theory that more appropriately (and narrowly) defines the universe of profits to be split, the suggestion that those profits be split on a 50/50 basis – even when adjusted to account for certain individual circumstances – is insufficiently tied to the facts of the case, and cannot be supported." For these reasons, the court vacated and remanded for recalculation of damages.

## **6. Patent Co-Owner Can Preclude Infringement Suit**

*STC.UNM v. Intel Corp.*, 754 F.3d 940 (Fed. Cir. 2014). STC.UNM sued Intel for patent infringement, but the district court dismissed the suit for lack of standing because non-party Sandia Corp. was a co-owner of the patent but it had not voluntarily joined as a co-plaintiff and could not be involuntarily joined. The Federal Circuit affirmed, concluding that all co-owners must consent to join as plaintiffs in an infringement suit. The Federal Circuit explained that there are only scenarios that can overcome this rule: First, when a patent owner has granted an exclusive license, he can be involuntarily joined. Second, if the co-owner waives his right to join the suit, his co-owners may force him to join in a suit against infringers. Because neither of those scenarios was present, the Federal Circuit affirmed the dismissal. Judge Newman dissenting, arguing that Rule 19 provided for involuntary joinder of the non-consenting co-owner of the patent.

## **7. Stays of Litigation Pending PTO Review of Patent**

*Virtualagility Inc. v. Salesforce.com, Inc.*, 759 F.3d 1307 (Fed. Cir. 2014). Virtualagility sued Salesforce.com and several other defendants for infringing a U.S. patent directed to processing management information. Shortly after the suit was filed, Salesforce.com filed a petition with the U.S. Patent Trial and Appeal Board (PTAB) seeking post-grant review of all claims of the patent under the so-called "Covered Business Method (CBM) Review" program. A few days later, the defendants filed a motion to stay the district court proceedings pursuant to AIA § 18(b)(1). While the motion was pending, the PTAB granted the petition to review the patent. The district court thereafter denied the motion to stay, and the defendants appealed the denial to the Federal Circuit, which is permitted by statute as an interlocutory appeal.

The Federal Circuit looked at the four factors provided under the statute to decide

whether an a stay should be granted: (1) whether a stay would simplify the issues for trial; (2) whether discovery is complete; (3) whether a stay would prejudice the nonmoving party; and (4) whether a stay would reduce the burden of litigation.

The Federal Circuit began by sidestepping the standard of review, holding that even under a more deferential abuse of discretion standard, the district court's decision to deny a stay was erroneous. According to the Federal Circuit, "the district court erred as a matter of law to the extent that it decided to 'review' the PTAB's determination that the claims of the '413 patent are more likely than not invalid in the posture of a ruling on a motion to stay." The Federal Circuit also found it significant that the PTAB granted review of all claims of the single asserted patent. "This CBM review could dispose of the entire litigation: the ultimate simplification of issues."

#### **8. Consumer Groups May Lack Standing to Attack Patents**

*Consumer Watchdog v. Wisconsin Alumni Research Foundation*, 753 F.3d 1258 (Fed. Cir. 2014). Consumer Watchdog requested inter partes reexamination of a patent directed to human embryonic stem cell cultures. It appealed from the PTAB's decision affirming the patentability of the claims of the patent. The Federal Circuit dismissed the appeal, concluding that Consumer Watchdog lacked Article III standing to pursue the appeal. In particular, Consumer Watchdog had no involvement in any research or commercial activities involving human embryonic stem cells, and had failed to identify any injury aside from the PTAB's denying the particular outcome it desired. "Because Consumer Watchdog has not identified a particularized, concrete interest in the patentability of the '913 patent, or any injury in fact flowing from the Board's decision, it lacks standing to appeal the decision affirming the patentability of the amended claims."

#### **9. Contempt Order Not Appealable Until Sanctions Determined**

*Arlington Industries, Inc. v. Bridgeport Fittings, Inc.*, 759 F.3d 1333 (Fed. Cir. 2014). Arlington sued Bridgeport in for infringing a patent relating to a method for connecting electrical cables to a junction box. The parties entered into a settlement agreement under which Bridgeport agreed to be enjoined from making and selling certain products. Years later, after Bridgeport had redesigned its products, Arlington sought a contempt order holding that the redesigned connectors violated the injunction. The district court found that Bridgeport was in contempt of the injunction and also expressly enjoined the sale of the redesigned connectors, but before it determined any sanctions for the contempt, Bridgeport appealed to the Federal Circuit. The Federal Circuit dismissed the appeal, concluding that because the district court had not modified the injunction but merely interpreted it, the decision was not a final decision ripe for appeal. The court concluded that the earlier 2004 injunction and the newly-issued order were directed to the same parties, applied to the same activities, and were in force for the same time period. Even though the district court's newly-issued injunction differed slightly in wording from the earlier 2004 order, it did not change the scope of the earlier injunction, which applied to

products that were not “colorably different” from the ones found to infringe.

#### **10. Declaratory Judgment Jurisdiction Where Customers Are Sued**

*Microsoft Corp. v. Datatarn, Inc.*, 755 F.3d 899 (2014). Datatarn sued several customers of Microsoft and SAP for infringing two of its patents. Datatarn sent the customers claim charts showing how their use of Microsoft’s and SAP’s software infringed the patents, with reference to certain Microsoft and SAP product manuals showing how to use the software. After several of the customers demanded indemnity from Microsoft and SAP, the latter filed declaratory judgment actions against Datatarn, seeking a declaratory judgment that the patents were invalid and not infringed. The district court refused to dismiss the DJ actions because Datatarn had provided claim charts showing infringement and because of the indemnification demands from the customers. The Federal Circuit affirmed the denial of the dismissal motions, concluding that although it was not enough to base jurisdiction on the indemnity demands, the fact that Datatarn provided claim charts pointing to Microsoft and SAP manuals as the basis for infringement gave rise to a substantial controversy regarding whether they induced infringement.

#### **11. Inequitable Conduct**

*Apotex Inc. v. UCB, Inc.*, 763 F.3d 1354 (Fed. Cir. 2014). Since the Federal Circuit’s 2011 en banc decision in *Therasense Inc. v. Becton, Dickinson and Co.*, 649 1276 (Fed. Cir. 2011), it has been much harder to prove that a patent applicant engaged in inequitable conduct that renders a patent unenforceable. This is a rare case in which such a ruling was upheld. Apotex owns a patent for a process for manufacturing a pharmaceutical drug that treats hypertension. Apotex’s founder and chairman drafted the patent application, which included certain examples of experiments that were never conducted. He also hired an expert to persuade the U.S. PTO to allow the patent, based partly on false information regarding what was known in the prior art. The district court found that the founder’s testimony at trial was not credible, and that he intended to mislead the PTO based on the never-conducted experiments and the falsely submitted information. The Federal Circuit affirmed, concluding that the patent specification and the affirmative misrepresentations were material to patentability (i.e., the PTO would never have issued the patent absent the misconduct). The Federal Circuit also concluded that there was intent to deceive the PTO, based on the founder’s extensive prior patent prosecution experience. Accordingly, the patent was held to be unenforceable and the infringer was not liable for patent infringement.

#### **14. Burden of Proving Infringement in a DJ Action**

*Medtronic, Inc. v. Mirowski Family Ventures, LLC*, 134 S.Ct. 843 (2014). The U.S. Supreme Court reversed the Federal Circuit in this case, holding that the burden of proving patent infringement remains on the patent owner, even when a licensee seeks a declaratory judgment of noninfringement. According to the Supreme Court:

“When a patent licensee paying royalties into an escrow account under a patent licensing agreement seeks a declaratory judgment that some of its products are not covered by or do not infringe the patent . . . the burden of persuasion is with the patentee, just as it would be had the patentee brought an infringement action.”

**15. Severing/Staying Infringement Suits Against Customers**

*In re Nintendo of America, Inc.*, 756 F.3d 1363 (Fed. Cir. 2014). The Federal Circuit granted Nintendo’s petition for a writ of mandamus, and directed that the Eastern District of Texas transfer a patent infringement claim against Nintendo to the Western District of Washington, where most of its evidence resided, and to stay the remaining case against Nintendo’s retailer customers. “When a patent owner files an infringement suit against a manufacturer’s customer and the manufacturer then files an action of noninfringement or patent invalidity, the suit by the manufacturer generally takes precedence.”

# **PATENTS**

**COUNSELING,  
OPINIONS &  
LICENSING**



**The USPTO Announces New  
Guidelines for Determining Subject  
Matter Eligibility Under 35 U.S.C. §  
101 in View of *Myriad*, *Prometheus*  
and *Chakrabarty***

**John P. Iwanicki**

***Banner & Witcoff Intellectual  
Property Alert***

**March 10, 2014**

## Intellectual Property Alert: The USPTO Announces New Guidelines for Determining Subject Matter Eligibility Under 35 U.S.C. §101 in View of *Myriad*, *Prometheus* and *Chakrabarty*

By John P. Iwanicki

March 10, 2014 – On March 4, 2014, the United States Patent & Trademark Office issued guidelines for the examination of “all claims (i.e., machine, composition, manufacture and process claims) reciting or involving laws of nature/natural principles, natural phenomena, and/or natural products” in view of the U.S. Supreme Court decisions in *Myriad*, *Prometheus* and *Chakrabarty*. The goal of the Examiners is to determine “whether a claim reflects a significant difference from what exists in nature and thus is eligible, or whether a claim is effectively drawn to something that is naturally occurring.”

The guidelines emphasize “the Office’s reliance on *Chakrabarty*’s criterion for eligibility of natural products (i.e., whether the claimed product is a non-naturally occurring product of human ingenuity that is markedly different from naturally occurring products)” and that “claims reciting or involving natural products should be examined for a marked difference under *Chakrabarty*.”

### THE TEST

The Examiners are instructed to follow the flowchart below to determine whether a claim should be rejected as ineligible subject matter under 35 U.S.C. §101.

The flowchart requires the Examiner to assess whether the claim includes a law of nature/natural principle, natural phenomena or natural product, i.e. a judicial exception. Examples include:

the law of gravity,  $F=ma$ , sunlight, barometric pressure, etc.;

a citrus fruit, uranium metal, nucleic acid, protein etc.;

chemicals derived from natural sources (e.g., antibiotics, fats oils, petroleum derivatives, resins, toxins, etc.); foods (e.g., fruits, grains, meats and vegetables); metals and metallic compounds that exist in nature; minerals, natural minerals (e.g., rocks, sands, soils); nucleic acids; organisms (e.g., bacteria, plants and multicellular animals); proteins and peptides; and other substances found or derived from nature.

If the claim includes a law of nature/natural principle, natural phenomena or natural product, then the Examiner is required to determine whether the claim as a whole recites something *significantly different* than the law of nature/natural principle, natural phenomena or natural product. According to the guidelines, a significant difference can be shown in multiple ways. For example:



(1) the claim includes elements or steps in addition to the judicial exception that practically apply the judicial exception in a significant way, e.g., by adding significantly more to the judicial exception; and/or (2) the claim includes features or steps that demonstrate that the claimed subject matter is markedly different from what exists in nature (and thus not a judicial exception).

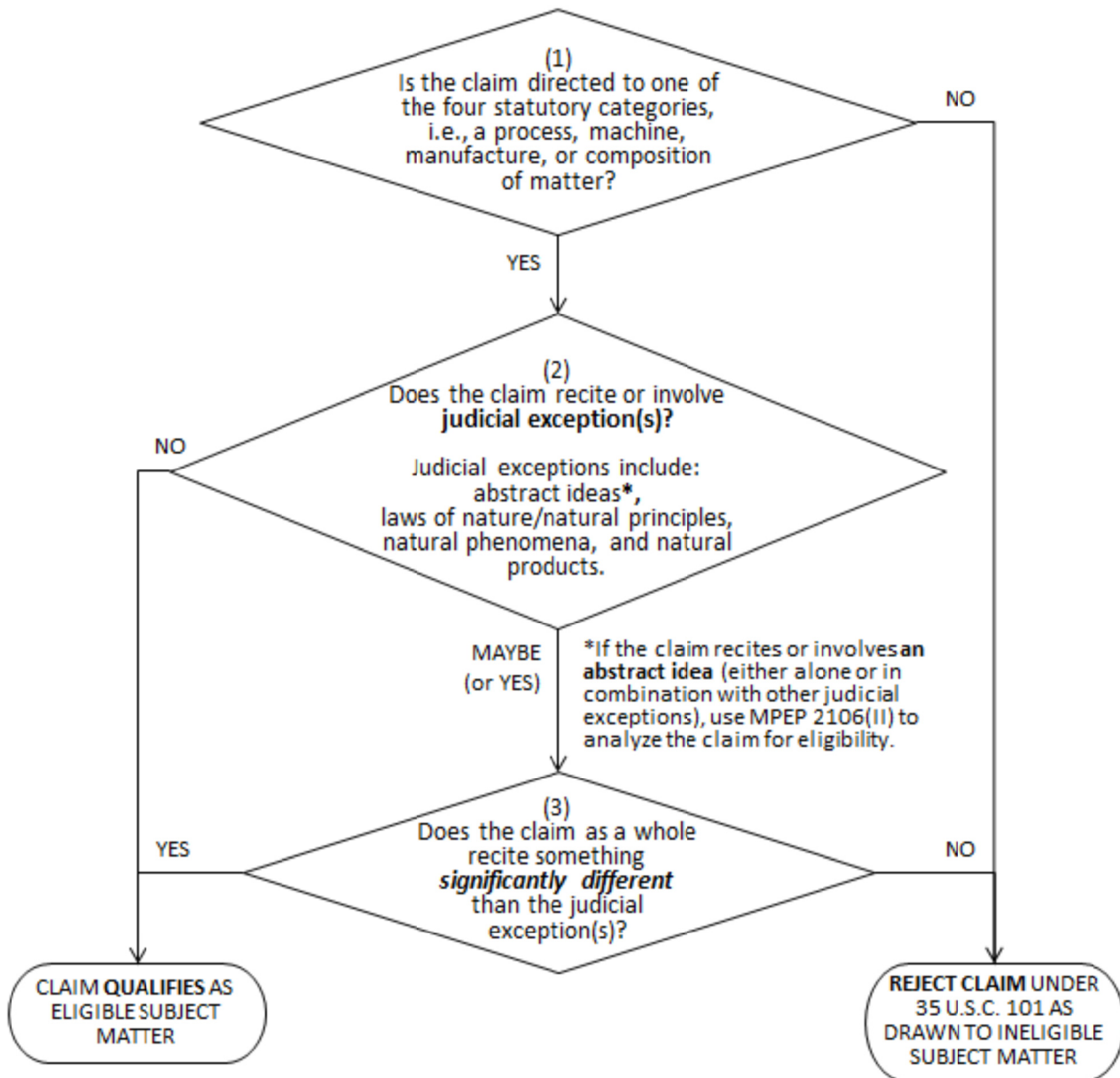

## GUIDING FACTORS

Factors that weigh toward eligibility (significantly different):

a) Claim is a product claim reciting something that initially appears to be a natural product, but after analysis is determined to be non-naturally occurring and markedly different in structure from naturally occurring products.

- b) Claim recites elements/steps in addition to the judicial exception(s) that impose meaningful limits on claim scope, i.e., the elements/steps narrow the scope of the claim so that others are not substantially foreclosed from using the judicial exception(s).
- c) Claim recites elements/steps in addition to the judicial exception(s) that relate to the judicial, exception in a significant way, i.e., the elements/steps are more than nominally, insignificantly or tangentially related to the judicial exception(s).
- d) Claim recites elements/steps in addition to the judicial exception(s) that do more than describe the judicial exception(s) with general instructions to apply or use the judicial exception(s).
- e) Claim recites elements/steps in addition to the judicial exception(s) that include a particular machine or transformation of a particular article, where the particular machine/transformation implements one or more judicial exception(s) or integrates the judicial exception(s) into a particular practical application. (See MPEP 2106(II)(B)(1) for an explanation of the machine or transformation factors.)
- f) Claim recites one or more elements/steps in addition to the judicial exception(s) that add a feature that is more than well-understood, purely conventional or routine in the relevant field.

Factors that weigh against eligibility (not significantly different):

- g) Claim is a product claim reciting something that appears to be a natural product that is not markedly different in structure from naturally occurring products.
- h) Claim recites elements/steps in addition to the judicial exception(s) at a high level of generality such that substantially all practical applications of the judicial exception(s) are covered.
- i) Claim recites elements/steps in addition to the judicial exception(s) that must be used/taken by others to apply the judicial exception(s).
- j) Claim recites elements/steps in addition to the judicial exception(s) that are well-understood, purely conventional or routine in the relevant field.
- k) Claim recites elements/steps in addition to the judicial exception(s) that are insignificant extra-solution activity, e.g., are merely appended to the judicial exception(s).
- l) Claim recites elements/steps in addition to the judicial exception(s) that amount to nothing more than a mere field of use.

## **EXAMPLES**

For product or composition claims, the Examiners are provided with examples for determining eligibility of subject matter under 35 U.S.C. §101 that focus on whether the claimed subject matter is markedly different in structure from a natural product. The guidelines note that the structural changes to nucleic acids resulting from their isolation are not markedly different from naturally occurring nucleic acids. “[A] marked difference must be a significant difference, i.e., more than an incidental or trivial difference.”

cDNA, hybrid plants and genetically modified bacteria are given as examples of being markedly different in structure from naturally occurring DNA or naturally occurring plants even though the methods of making such cDNA or hybrid plants may be considered routine manipulation of natural processes.

An isolated compound from a natural source is not markedly different from the natural product. However, a synthetic derivative of the compound that has a different property from the natural product may be markedly different from the natural compound. Also, a use of the product in its isolated form according to a dosage amount and regimen to treat a particular disease that otherwise could not be treated by the compound in its natural form may be markedly different subject matter.

Articles of manufacture including naturally occurring substances are considered statutory subject matter where the article includes “something significantly different from the natural products themselves.” The example given is a firework including a cardboard body, sparking composition, and ignition fuse in addition to the naturally occurring calcium chloride and gunpowder formulations. This amounts to a specific practical application of the natural products.

Compositions of multiple natural products may not be statutory subject matter where the combination does not result in properties markedly different from what exists in nature. For example, where different species of naturally occurring bacteria are combined and each species is unaffected in its properties by the other species, then the composition may not be markedly different from the individual naturally occurring bacteria.

A claim to primers of specific sequences is not statutory subject matter where the sequences are naturally occurring sequences found on a human chromosome. However, a claim to the use of the primers to amplify target DNA using a template, a polymerase, nucleotides and reaction conditions may be statutory subject matter because the claim amounts to a practical application of the natural product primers.

A method claim to diagnosing whether an individual has a degenerative disease may not be statutory subject matter where a natural principle, i.e., a mere correlation between a degenerative disease and the presence of a metabolite, is all that is required by the claims. However, when the claimed method uses an antibody that does not exist in nature and is not purely conventional or routine in the art, i.e., it was created by the inventors, then the method may be statutory subject matter because the claim recites something significantly different from the natural principle and amounts to a practical application of the natural principle.

A method claim to treating an individual by subjecting the individual to natural principle or natural phenomena without more may not be statutory subject matter. The guidelines present an example where an individual is treated with sunlight to alter neuronal activity, which leads to mitigation of a mood disorder. It is known that white light changes neuronal activity and affects a person’s mood and that sunlight is a natural source of white light. Therefore, the use of sunlight is purely conventional and routine in the art of treating mood disorders. Even if the source of white light is synthetic and not natural, the use of a synthetic source is not significantly different from the natural principle itself and does not amount to a practical application of the natural principle. However, where conditions such as filtering ultraviolet rays from a white light source, positioning a patient a distance from the white light source and other treatment conditions are recited in a claim, the claim may recite something significantly different from the natural principle such that the claim is a practical application of the natural principle.

To subscribe or unsubscribe to this Intellectual Property Advisory,  
please send a message to Chris Hummel at [chummel@bannerwitcoff.com](mailto:chummel@bannerwitcoff.com)



[www.bannerwitcoff.com](http://www.bannerwitcoff.com)



**The First-To-File Toolbox: Intake,  
Checklists, Templates**

**Aseet Patel**

***Law360 Expert Analysis***

**May 20, 2014**



---

**Portfolio Media, Inc.** | 860 Broadway, 6th Floor | New York, NY 10003 | [www.law360.com](http://www.law360.com)  
Phone: +1 646 783 7100 | Fax: +1 646 783 7161 | [customerservice@law360.com](mailto:customerservice@law360.com)

---

## The First-To-File Toolbox: Intake, Checklists, Templates

Law360, New York (May 20, 2014, 12:41 PM ET) -- Under the Leahy-Smith America Invents Act, the United States has moved from a first-to-invent regime to a first-inventor-to-file (FITF) regime. The prevalent advice has been to file quickly because time is of the essence. What can we, as patent practitioners, do to ensure that the patent applications we're trying to get on file as quickly as possible are also high-quality patent applications?

First, we must adapt to inventors and tailor the invention submission process to them. Second, we can use an AIA-compliant checklist for invention disclosure meetings to ensure that all questions for inventors are expeditiously addressed. And third, we can gain efficiencies by having ready-to-use, custom patent application templates.

### Tailor Invention Intake for Inventors

A key to reducing the time from invention conception to patent application filing is to make the invention submission process convenient and more painless for everyone involved, particularly the inventors. Many companies continue to use the traditional, pre-AIA invention disclosure forms that caused inventors much angst. Inventors complained about the length of the forms, and the number and type of questions in these one-size-fits-all forms. Since these forms were painful and time-consuming, inventors postponed completing them. Invention submissions sat on inventors' desks and were delayed in getting to in-house counsel. Under the AIA's FITF regime, it's more important than ever to address this bottleneck.

The pre-AIA one-size-fits-all approach is no longer efficient. While the old disclosure forms will still work in some cases, they do not encourage inventors to submit inventive concepts as quickly as needed under the AIA. Rather, the invention submission process must be tailored to the specific type of inventor/inventive teams. Some factors to consider when determining the best approach for obtaining disclosures include: (1) inventors' time constraints and availability; (2) inventor incentive programs; (3) inventors' patent experience and training; and (4) size and location of the inventive team.

For example, if meeting requests to inventors are being ignored, taking another approach is prudent. For nonresponsive inventors, one effective strategy is for patent counsel to call the inventor instead of sending an email. Some busy inventors receive hundreds of emails each day and a request for an invention disclosure meeting could get buried in their inbox. Efficient handling of a nonresponsive inventor is especially critical under a FITF regime.

As such, an even more effective strategy is to intertwine innovation with the company's compensation structure and annual employee review. Many companies already have programs in place to monetarily reward employees for submitting an invention disclosure, assisting patent counsel in filing a patent application, being listed as an inventor on a granted patent, or being listed on a patent licensed[1] to a third party.

At exactly what stage in the process the inventors are compensated can also affect the effectiveness of a company's inventor incentive program. Only compensating inventors at patent grant or upon licensing, which might not occur until many years after the invention conception, might leave the incentive too far into the future to be effective. Meanwhile, paying inventors for every invention submission, whether or not it is pursued in a patent application, might open the floodgates to low-quality invention submissions.[2] Striking a balance is important. Empirically, more companies pay inventors at patent application filing than at any other time.[3]

Sometimes even more effective than monetary rewards are accolades and "bragging rights." Some companies reward their most proactive inventors with a private, annual dinner with the CEO. Trophies or plaques have also proven effective for some companies. The end goal is to eliminate nonresponsiveness from inventors.

The bedrock of an innovation culture is proper intellectual property training. Employees trained to flag IP issues are in a better position to bring them to the patent counsel's attention in a timely and efficient manner. The training they receive must be tailored to the company's industry. For example, with consumer goods companies, capturing and patenting the user experience aspects of a paper towel roll or resealable plastic bags can be very valuable.[4] These potential inventors should be trained to spot these types of features when they arise and elevate the issue to patent counsel. More importantly, a well-trained inventor will provide quality, concise invention submissions[5] that will translate into faster, high-quality patent application filings.

Providing IP training to employees has, in economic terms, spillover benefits that far outweigh the cost and effort of providing the training. The training can be as basic as helping scientists, programmers, and marketers better appreciate the amount of detail that needs to go into a patent application by way of a high-level discussion about the written description and enablement requirements of patent law. The company's invention disclosure submissions should see a noticeable improvement.

Under the AIA, it's more important than ever to create a robust IP training program that will create cheerleaders for IP amongst the employee ranks. These innovation enthusiasts will help drive invention submissions, and can also serve as gatekeepers when patent counsel comes across nonresponsive inventors in their teams.

Having a gatekeeper is particularly helpful when faced with large inventive teams. Gatekeepers can help facilitate an efficient, coordinated review of the draft patent application, as well as follow up with nonresponsive co-inventors. Moreover, when dealing with a large inventive team, it's even more important to obtain early on the country of residence of each inventor. If inventors reside in a country with foreign filing license requirements (e.g., India), counsel must build in time to obtain a foreign filing license before filing in the U.S. It's best to start the licensing process concurrent with other tasks in the pre-filing timeline to avoid filing delays.

## **Develop an Invention Disclosure Meeting Checklist**

With so many moving parts while also racing against the clock, it's critical for attorneys to use a robust invention disclosure meeting checklist to ensure efficient use of inventor time and to avoid delays. To be effective, the checklist should be manageable and easy to reference. A sample one-page checklist can be downloaded here.

It's important to customize the checklist to each specific company, as well as periodically revisiting it to keep it fresh. For example, a consumer goods company might include strategic questions directed at capturing the user experience. Meanwhile, every company should confirm their checklist is up-to-date with the requirements of the AIA. For example,

under the AIA, attorneys must educate inventors about the expanded universe of prior art, which now includes worldwide public uses. Furthermore, while the AIA provides for a public disclosure “grace period” of sorts, if any such public disclosure has occurred, attorneys should capture and preserve the pertinent facts surrounding the disclosure. These facts and documents will form the basis of any future invocation of a 35 USC 102(b)(1) exception, or affidavits under 37 CFR 1.130(a) or 1.130(b) for attribution or prior public disclosure, respectively.

Having a checklist ensures that each topic is sufficiently covered during what may be the attorney’s first, and possibly only meeting, with all of the inventors. With the checklist in hand, the attorney can ask all the questions he or she needs, and then return to the office to efficiently draft a quality patent application.

## **Customize Patent Application Templates**

Even with responsive inventors who are sufficiently incentivized, what can patent attorneys do to ensure that the patent applications they are drafting on a shortened timeline are also of high quality? Patent application templates can be helpful by jump-starting the drafting process.

However, as with the invention disclosure meeting checklist, the patent application template must be tailored to the company’s industry and product offerings. For example, the template for a banking institution might include stock figures showing a systems level diagram of interactions between ATM machines, tellers, vaults, bar code scanners, and the MICR strip on a check. Meanwhile, the stock figures for a consumer goods company would be very different.

Companies typically have numerous product lines and multiple divisions. Consequently, most companies will need more than one patent application template. Specifically, a versatile template will include numerous figures with corresponding descriptions. It’s up to the attorney to select which figures are appropriate to include in the patent application for the particular invention. Moreover, the custom template should take into account the company’s foreign filing predilections and the idiosyncrasies of those jurisdictions — e.g., avoiding foreign language translation costs by excluding unnecessary text in the figures.

When preparing a starter template for a company, in addition to conferring with in-house counsel and business clients, consider the following information:

- Organizational charts of the divisions and departments of the company;
- Company’s product offerings and groupings;
- 10K filing, if a publicly traded company;
- Recent patents and published patent applications;
- Closest competitors’ recent patents and published patent applications; and
- three to five “blue sky” prophetic features of the industry.

Of course, a discussion about patent application templates would be incomplete without a word of caution. Attorneys should remain vigilant of how the stock material is prepared and where that stock material is used/reused.[6] The Cold Spring Harbor Laboratories case [7] and the Tethys Biosciences case[8] provide us with some insight.

The Cold Spring Harbor Laboratories case is a lawsuit brought by Cold Spring Harbor Laboratories (CSHL) against its attorney. CSHL developed a method to regulate gene expressions by using synthetic RNA molecules called “short hairpin RNAs.” CSHL alleged that when its attorney drafted its patent application, he bulk copied portions from another of his client’s applications into the detailed description section of CSHL’s new application.

CSHL argued that because of this, the USPTO rejected CSHL's patent application in view of the publication from which the text was copied. The CSHL case was dismissed for improper venue and transferred to Massachusetts state court where, as of the writing of this article, it is currently pending.[9]

Meanwhile, the Tethys Biosciences case involves Tethys Bioscience alleging that its attorney took portions from Tethys Bioscience's provisional patent application and later re-used it in another client's patent application. In response to a motion to dismiss, the court held that Tethys Bioscience had sufficiently stated its claim. The court reasoned that even if the copied portions were high-level background information that a person with ordinary skill in the art would have known, the manner in which that information was presented in the provisional patent application was not publicly known. The attorney had a duty of confidentiality to his client, and sometimes this can mean that otherwise public information is barred as confidential based on the specific facts of the case. The Tethys Bioscience case settled and was dismissed without a final verdict from the court.

Key points to remember when creating a company's patent application template include setting expectations and providing full disclosure. Taking a page from the U.S. Patent and Trademark Office's rule book,[10] provide full disclosure to clients as to the source of stock language in the template. As explained earlier, since templates need to be customized to the particulars of the company, it's best to create fresh content. However, if any of the content will be recycled, regardless of whether or not the source is public, make this clear to all parties involved. The situations in CSHL and Tethys Bioscience might have been avoided altogether had full disclosure occurred upfront between all the parties involved.

## Conclusion

With these additions to our patent practitioner's toolbox, we are closer to successfully filing quality patent applications for clients in record time under the AIA. Moving forward, the impetus is on us, as in-house counsel and outside counsel, to keep our tools sharp. It's important to revisit the patent application template periodically (perhaps even quarterly) to keep it from getting stale. As your company's industry, product offerings and competitors change, so should your template, checklist and inventor intake process.

—By Aseet Patel, Banner & Witcoff Ltd.

*Aseet Patel is a partner in Banner & Witcoff's Chicago office.*

*The opinions expressed are those of the author(s) and do not necessarily reflect the views of the firm, its clients, or Portfolio Media Inc., or any of its or their respective affiliates. This article is for general information purposes and is not intended to be and should not be taken as legal advice.*

[1] See Kassab, Chris, "Ford Offers Employees Added Incentives to Become Inventors," available at [ford.com](http://ford.com), Sept. 12, 2011 ("The second new award, the Technology License Income Award, will recognize Ford inventors named in an original patent issued to Ford if the patented invention is licensed to a third party by Ford for royalty income. The award is 30 percent of the royalty income received up to a maximum award of \$50,000 to be divided between inventors.")

[2] A word of caution here: If you are putting a new incentive structure in place and find that the size of your inventor teams has changed drastically, take a minute to scrutinize the inventor team. The requirements for being a co-inventor remain the same pre-AIA and under the AIA. Although the desired timeline for filing has been shortened, we must still stand guard of application formalities, such as identifying correct inventorship.

[3] See IPO – Employee Inventor Compensation Practices Survey, Report of the IPO Asian



Practices Committee, Feb. 2004.

[4] See Bloomberg BNA, "The Total User Experience: Improving the Content and Quality of Your Company's Patent Application Process Post-AIA," December 2013, available at <http://www.bna.com/total-user-experience-w17179879898>.

[5] The Hayes Court explained that it's about quality, not quantity: "While some inventions require more disclosure, the adequacy of the description of an invention depends on its content in relation to the particular invention, not its length." See *In re Hayes Microcomputer Prods.* (Fed. Cir. 1992).

[6] See Hricik, David, "Copying Text from One Client's Patent into Another's Application," 5 No. 5 *Landslide* 22, May/June 2013.

[7] *Cold Spring Harbor Laboratory v. Ropes & Gray LLP et al.*, 840 F. Supp. 2d 473 (D. Mass. 2012).

[8] *Tethys Bioscience, Inc. v. Mintz et al.*, 98 U.S.P.Q.2d 1585 (N. D. Cal. 2010).

[9] Although now in Massachusetts state court, federal court Judge Richard G. Stearns has been quoted on several occasions for his statement regarding copying: "This citation to a popular how-to reference book, which states that copying is an accepted practice in patent drafting, is dubious at best and, at worst, an insult to the professional standards of the patent bar."

[10] The USPTO's rules contemplate some amount of "recycling." Under the Office's incorporation by reference practice, prior publications can be incorporated by reference into a patent application as if they were copied directly into the application. Likewise, the Office recognizes continuation-in-part applications that allow patent applications to claim the benefit of a previous application filing. However, in both instances, the Office requires that the source of the copying be expressly identified in the patent application.

---

All Content © 2003-2014, Portfolio Media, Inc.



**The AIA Toolbox: Intake, Check-  
lists, and Faster Drafting Techniques**

**Aseet Patel and Bradley J. Van Pelt**

***Banner & Witcoff Intellectual  
Property Update***

**September 19, 2014**

# UPDATE

FALL/WINTER 2014

## THE AIA TOOLBOX: INTAKE, CHECKLISTS, AND FASTER DRAFTING TECHNIQUES



BY: ASEET PATEL  
AND BRADLEY J.  
VAN PELT

The United States has moved from a first-to-invent (FTI) regime to a first-inventor-to-file (FITF) regime under the Leahy-Smith America Invents Act (AIA). Most companies strive to file quickly to win the race to the U.S. Patent and Trademark Office (USPTO). What can companies do to ensure that the patent applications they are trying to file quickly are also high-quality patent applications? Generally, the key is to eliminate gaps between conception of the invention, disclosure of the invention to the application drafters, and filing the application with the USPTO. Ways to reduce these gaps include tailoring the invention submission process to the inventor, using an AIA-compliant checklist to ensure that all questions for inventors are expeditiously addressed at the initial invention disclosure meeting, and streamlining the preparation of the application by employing faster drafting techniques.

### TAILORING INVENTION INTAKE FOR INVENTORS

A key to reducing the time from invention conception to patent application filing is to make the invention submission process convenient and more painless for everyone involved, particularly the inventors. Many companies continue to use the traditional, pre-AIA invention disclosure forms that caused inventors much angst. Inventors complained about the length of the forms, and the number and type of questions in these one-size-fits-all forms. Since these forms were painful and time-consuming, inventors postponed completing them. Invention submissions sat on inventors' desks and were delayed in getting to in-house counsel. Under the AIA's FITF regime, it is more important than ever to address this bottleneck.

The pre-AIA one-size-fits-all approach is no longer efficient. While the old disclosure forms will still work in some cases, they do not encourage inventors to submit inventive concepts as quickly as needed under the AIA. Rather, the invention submission process must be tailored to the **MORE ►**

### IN THIS ISSUE

- 1 The AIA Toolbox: Intake, Checklists, and Faster Drafting Techniques
- 7 NFL Teams 0-2 in the TTAB
- 9 NFL Redskins Federal Trademark Registrations Cancelled
- 13 Virtual Design Theft Update: 3D Printing
- 17 Supreme IP: The U.S. Supreme Court Weighs In On IP Rights

[AIA TOOLBOX, FROM PAGE 1]

specific type of inventor/inventive teams. Some factors to consider when determining the best approach for obtaining disclosures include: (1) inventors' time constraints and availability; (2) company intellectual property (IP) culture (e.g., inventor incentive programs); (3) inventors' patent experience and training; and (4) size and location of the inventive team.

For example, if meeting requests to inventors are ignored, taking another approach is prudent. For non-responsive inventors, one effective strategy is for patent counsel to call the inventor instead of sending an e-mail.

## "The bedrock of an innovation culture is proper IP training."

Some busy inventors receive hundreds of e-mails each day and a request for an invention disclosure meeting could get buried in their inbox. Efficient handling of a non-responsive inventor is especially critical under a FITF regime. As such, an even more effective strategy is to create a corporate culture that values IP. Intertwining innovation with the company's compensation structure and annual employee review creates a culture that values IP. Many companies already have programs in place to monetarily reward employees for submitting an invention disclosure, assisting patent counsel in filing a patent application, being listed as an inventor on a granted patent, or being listed on a patent licensed<sup>1</sup> to a third party. At exactly what stage in the process the inventors are compensated can also influence the effectiveness of a company's inventor incentive program. Only compensating inventors at patent grant or upon licensing, which might not occur until many years after the invention conception, can leave the incentive too far into the future to be

effective. Meanwhile, paying inventors for every invention submission, whether or not it is pursued in a patent application, might open the floodgates to low-quality invention submissions.<sup>2</sup> Striking a balance is important. Empirically, more companies pay inventors at patent application filing than at any other time.<sup>3</sup>

Sometimes even more effective than monetary rewards are accolades and "bragging rights." Some companies reward their most proactive inventors at a private, annual dinner with the CEO. Trophies or plaques have also proven effective for

some companies in developing a strong corporate IP culture. Companies have also built inventor halls of fame that enshrine top inventors that have been granted many patents. One survey suggests that inventor incentive programs have better results when implemented by the R&D department as opposed to the legal department within an organization.<sup>4</sup> The objective is to promote a corporate culture that values IP to eliminate non-responsiveness from inventors during the disclosure and drafting process.<sup>5</sup>

The bedrock of an innovation culture is proper IP training. Explaining the effect of FITF will help employees understand why faster disclosures are required. Additionally, employees trained to flag IP issues are in a better position to bring them to the patent counsel's attention in a timely and efficient manner. The training they receive must be tailored to the company's industry. For example, with consumer goods companies, capturing and patenting the user experience aspects of a paper towel roll or re-sealable plastic bags can be very valuable.<sup>6</sup>

1. See Kassab, Chris, "Ford Offers Employees Added Incentives to Become Inventors," available at [ford.com](http://ford.com), Sept. 12, 2011 ("The second new award, the Technology License Income Award, will recognize Ford inventors named in an original patent issued to Ford if the patented invention is licensed to a third party by Ford for royalty income. The award is 30 percent of the royalty income received up to a maximum award of \$50,000 to be divided between inventors.")
2. A word of caution here: If you are putting a new incentive structure in place and find that the size of your inventor teams has changed drastically, take a minute to scrutinize the inventor team. The requirements for being a co-inventor remain the same pre-AIA and under the AIA. Although the desired timeline for filing has been shortened, we must still stand guard of application formalities, such as identifying correct inventorship.
3. See IPO – Employee Inventor Compensation Practices Survey, Report of the IPO Asian Practices Committee, February 2004.
4. See Bell, Jacqueline, "Invention Incentive Programs Get Results: Survey," January 2009, available at <http://www.law360.com/articles/85031/invention-incentive-programs-get-results-survey>.
5. Also being sued for patent infringement by a competitor promotes a stronger IP culture because it heightens the company's awareness to patents, which triggers more disclosures and filings. Another proactive approach is educating the company that good fences make good neighbors. In particular, companies with strong patent portfolios are less likely to be sued because plaintiffs will fear the potential countersuits that may be brought against them.
6. See Bloomberg BNA, "The Total User Experience: Improving the Content and Quality of Your Company's Patent Application Process Post-AIA," December 2013, available at <http://www.bna.com/total-user-experience-w17179879898>.

These potential inventors should be trained to spot these types of features when they arise and elevate the issue to patent counsel. More importantly, a well-trained inventor will provide quality, concise invention submissions<sup>7</sup> that will translate into faster, high-quality patent application filings. Providing IP training to employees has, in economic terms, spillover benefits that far outweigh the cost and effort of providing the training. The training can be as basic as helping scientists, programmers, and marketers better appreciate the amount of detail that needs to go into a patent application by way of a high-level discussion about the written description and enablement requirements of patent law. The training should also include information about the company's inventor reward programs. As a result of the training, the company's invention disclosure submissions should see a noticeable improvement.

**“It is important to customize the checklist for each specific company, and to periodically revisit it to keep it fresh.”**

Creating a robust IP training program and a corporate culture that values IP will also create cheerleaders for IP amongst the employee ranks. These innovation enthusiasts will help drive invention submissions, and can also serve as gatekeepers when patent counsel comes across non-responsive inventors in their teams. Having a gatekeeper is particularly helpful when faced with large inventive teams. Gatekeepers can help facilitate an efficient, coordinated review of the draft patent application, as well as follow-up with non-responsive co-inventors. Moreover, when dealing with a large inventive team, it's even more important to obtain early-on the country of residence of each inventor.

If inventors reside in a country with foreign filing license requirements (e.g., India), counsel must build in time to obtain a foreign filing license before filing in the U.S. It is best to start the licensing process concurrent with other tasks in the pre-filing timeline to avoid filing delays.

### **DEVELOP AN INVENTION DISCLOSURE MEETING CHECKLIST**

It is critical for attorneys to use a robust invention disclosure meeting checklist to ensure efficient use of inventor time and to avoid delays. To be effective, the checklist should be manageable and easy to reference. A sample one-page checklist can be downloaded from <http://witcon2014.com/sessions/>.

It is important to customize the checklist for each specific company, and to periodically revisit it to keep it fresh. For example, a consumer goods company might include

strategic questions directed at capturing the user experience. Meanwhile, every company should confirm their checklist is up-to-date with the requirements of the AIA. For example, under the AIA, attorneys must educate inventors about the expanded universe of prior art, which now includes worldwide public uses. Furthermore, while the AIA provides for a public disclosure “grace period” of sorts, if any such public disclosure has occurred, attorneys should capture and preserve the pertinent facts surrounding the disclosure. These facts and documents will form the basis of any future invocation of a 35 USC 102(b)(1) exception, or affidavits under 37 CFR

**MORE ►**

7. The *Hayes Court* explained that it's about quality, not quantity: “While some inventions require more disclosure, the adequacy of the description of an invention depends on its content in relation to the particular invention, not its length.” See *In re Hayes Microcomputer Prods.* (Fed. Cir. 1992).

[AIA TOOLBOX, FROM PAGE 3]

1.130(a) or 1.130(b) for attribution or prior public disclosure, respectively.

Having a checklist ensures that each topic is sufficiently covered during what may be the attorney's first, and possibly only meeting, with all of the inventors. With the checklist in hand, the attorney can ask all the questions he or she needs, and then return to the office to efficiently draft a quality patent application.

### FASTER DRAFTING TECHNIQUES

Even with responsive inventors who are sufficiently incentivized, what can patent attorneys do to ensure that the patent applications they are drafting on a shortened timeline are also of high quality? Faster drafting techniques include using patent application templates, implementing dedicated prosecution teams, facilitating faster application review, and avoiding straying too far from the objectives of an invention or mission creep in drafting applications.

#### Patent Application Templates

Patent application templates can be helpful to jumpstart the drafting process. As with the invention disclosure meeting checklist, the patent application template must be tailored to the company's industry and product offerings. For example, the template for a banking institution might include stock figures showing a systems level diagram of interactions between ATM machines, tellers, vaults, bar code scanners, and the MICR strip on a check. Meanwhile, the stock figures for a consumer goods company would be very different.

Companies typically have numerous product lines and multiple divisions. Consequently, most companies will need more than one patent application template. Specifically, a versatile template will include numerous figures with corresponding descriptions. It's up to the attorney to select

which figures are appropriate to include in the patent application for the particular invention. Moreover, the custom template should take into account the company's foreign filing predilections and the idiosyncrasies of those jurisdictions — e.g., avoiding foreign language translation costs by excluding unnecessary text in the figures.

When preparing a starter template for a company, in addition to conferring with in-house counsel and business clients, consider the following information:

- Organizational charts of the divisions and departments of the company;
- Company's product offerings and groupings;
- 10K filing, if a publicly-traded company;
- Recent patents and published patent applications;
- Closest competitors' recent patents and published patent applications; and
- 3-5 "blue sky" prophetic features of the industry.

Of course, a discussion about patent application templates would be incomplete without a word of caution. Attorneys should remain vigilant of how the stock material is prepared and where that stock material is used/re-used.<sup>8</sup> The *Cold Spring Harbor Laboratories* case<sup>9</sup> and the *Tethys Biosciences* case<sup>10</sup> provide us with some guidance when using stock material.

The *Cold Spring Harbor Laboratories* case is a lawsuit brought by Cold Spring Harbor Laboratories (CSHL) against its attorney. CSHL developed a method to regulate gene expressions by using synthetic RNA molecules called "short hairpin RNAs." CSHL alleged that when its attorney drafted its patent application, he bulk copied portions from another of his client's applications into

8. See Hricik, David, "Copying Text from One Client's Patent into Another's Application," 5 No. 5 *Landslide* 22, May/June 2013.

9. *Cold Spring Harbor Laboratory v. Ropes & Gray LLP*, 840 F. Supp. 2d 473 (D. Mass. 2012).

10. *Tethys Bioscience, Inc. v. Mintz*, 98 U.S.P.Q.2d 1585 (N. D. Cal. 2010).

the detailed description section of CSHL's new application. CSHL argued that because of this, the USPTO rejected CSHL's patent application in view of the publication from which the text was copied. The CSHL case was dismissed for improper venue and transferred to Massachusetts state court where the parties eventually reached a settlement.<sup>11</sup>

Meanwhile, the *Tethys Biosciences* case involves Tethys Bioscience alleging that its attorney took portions from Tethys Bioscience's provisional patent application and later reused it in another client's patent application. In response to a motion to dismiss, the Court

**“Recurring interactions between the same attorneys and inventors allows everyone to work together cohesively and more efficiently.”**

held that Tethys Bioscience had sufficiently stated its claim. The Court reasoned that even if the copied portions were high-level background information that a person with ordinary skill in the art would have known, the manner in which that information was presented in the provisional patent application was not publicly known. The attorney had a duty of confidentiality to his client, and sometimes this can mean that otherwise public information is barred as confidential based on the specific facts of the case. The *Tethys Bioscience* case settled and was dismissed without a final verdict from the Court.

Therefore, key points to remember when creating a company's patent application template include setting expectations and providing full disclosure. Practitioners should provide full disclosure to clients as to the source of stock language in the template and look to the USPTO's rule book for guidance when reusing material from earlier applications and patents.<sup>12</sup> As explained earlier, since

templates need to be customized to the particulars of the company, it is best to create fresh content. However, if any of the content will be recycled, regardless of whether or not the source is public, make this clear to all parties involved. The situations in *CSHL* and *Tethys Bioscience* might have been avoided altogether had full disclosure occurred upfront between all the parties involved.

### Establishing Dedicated Prosecution Teams

Maintaining dedicated prosecution teams streamlines the drafting of applications. Recurring interactions between the same attorneys and inventors allows everyone to

work together cohesively and more efficiently. Moreover, the attorneys on the prosecution teams will gain institutional knowledge about the company's product lines and operation, which will help attorneys draft subsequent applications more quickly. For example, the drafting attorney will be on the same page as the inventor, and the invention disclosure meetings will go smoothly. The inventor will also be at ease, knowing the attorney understands the technology.

### Faster Application Review

Inventors may have many responsibilities outside of filing patent applications. Therefore, reviewing a lengthy technical patent application with multiple examples, diagrams, schematics and complicated claim language is not always an inventor's top priority. Patent counsel may need to periodically check in on the application review process to manage inventor feedback to ensure timely review. On multiple-inventor applications, **MORE ►**

11. Judge Richard G. Stearns of the District Court of Mass. has been quoted on several occasions for his statement in *CSHL v. Ropes & Gray* regarding copying: “This citation to a popular how-to reference book, which states that copying is an accepted practice in patent drafting, is dubious at best and, at worst, an insult to the professional standards of the patent bar.”
12. The USPTO's rules contemplate some amount of “recycling.” Under the Office's incorporation by reference practice, prior publications can be incorporated by reference into a patent application as if they were copied directly into the application. Likewise, the Office recognizes continuation-in-part applications that allow patent applications to claim the benefit of a previous application filing. However, in both instances, the Office requires that the source of the copying be expressly identified in the patent application.

[AIA TOOLBOX, FROM PAGE 5]

assigning a proactive inventor to facilitate the drafting of the application and to collect all of the feedback from the inventors greatly streamlines the review process. Encouraging inventor participation in the review process by shifting awards to patent filings may also speed up review of draft applications. Additionally, setting client-imposed deadlines on outside counsel also advances applications to filing.

#### **Avoid Mission Creep**

Avoiding mission creep, or shifting away from the main objectives of inventions during drafting, can help to reduce application preparation time. Drafting robust descriptions of the invention in patent applications is important. However, when preparing applications, it is easy to become carried away and to list multiple examples that expand beyond the original objectives of an application. This can delay the ultimate filing of the application and may also increase drafting costs because attorneys will spend more time preparing the application.

Once an application is developed with enough examples to broadly cover the key inventive concepts, the application should be filed. The additional inventive concepts discussed that are not included with the filing can be included in subsequent filings.

#### **CONCLUSION**

With these additions to our patent practitioner's AIA toolbox, we are closer to successfully filing quality patent applications for clients in record time. Streamlining the patenting process also offers the benefit of reducing the cost per application by reducing the drafting time, which results in cost savings to companies. Moving forward, the impetus is on us, as in-house counsel and outside counsel, to keep our tools sharp. It is important to revisit the patent application template periodically (perhaps even quarterly) to keep it from getting dull. As your company's industry, product offerings, and competitors change, so should your template, checklist, and inventor intake process. ■

## **SAVE THE DATE!**

### **First GW Law Design Patent Symposium**

Please save **Friday, Nov. 21, 2014**, for the First GW Law Design Patent Symposium at the GW Law School in Washington, D.C.

The program will present and foster debate on cutting edge design-related topics. The program will be directed toward an audience of design practice leaders throughout the U.S.; however, we expect that many others with an interest in design law will also be in attendance.

We expect corporate practitioners, USPTO representatives, product designers, professors and students to attend.

**Friday, Nov. 21, 2014**

All Day

#### **GW Law School**

2000 H Street NW  
Washington, D.C. 20052

**For more information**, please contact Chris Hummel at 202.826.3126 or [chummel@bannerwitcoff.com](mailto:chummel@bannerwitcoff.com).





**“Do the Due”: Performing Proper  
Diligence When Assessing IP Assets  
for Acquisition (Part 1)**

**John M. Fleming**

***Inside Counsel***

**October 24, 2014**

## Inside Counsel

# “Do the Due”: Performing proper diligence when assessing IP assets for acquisition

Knowing all of the benefits and issues before acquisition is the only way to ensure a well-reasoned patent acquisition

By [John M. Fleming](#)  
October 24, 2014

The concept of due diligence often arises when intellectual property (IP) assets become available for potential acquisition. Any number of reasons may lead to this availability. An asset may be for sale due to an entity going out of business or because an entity is in bankruptcy. An entity could also decide to sell the asset if there is simply no longer a need or desire to maintain rights in the asset, or due to another entity's inquiry into possibly acquiring that asset.

The importance of due diligence historically has been downplayed. For the most part, it didn't matter what condition an asset was in so long as it was acquired. Entities used intimidation tactics to walk into a negotiation with a stack of patents and simply say that “my stack is bigger than your stack.” To do so, they wanted assets, no matter the warts associated with them. Today, the litigation and negotiation environments are much different. Quality, not quantity, assets define a negotiation and whether one entity has IP leverage over another. Proper background checks in acquisition, whether for negotiation or defense purposes, now are more important than ever to determine and appreciate what assets are really available. An asset can have warts, and often does, but many are curable.

When determining whether to acquire an asset, you should take many considerations into account. The obvious one is the economics of the sale and its effect. Some IP offerings simply are too expensive on their face to even warrant a due diligence analysis. Even so, an entity should perform some manner of preliminary damages analysis should an infringement action be brought against it. If an entity decides not to acquire an IP asset for economic reasons, it should still address passing it up (whether through a due diligence analysis for unenforceability, non-infringement, or invalidity, or a preliminary economic analysis for infringement and design arounds) to appreciate the economic effect of that decision.

Still, the applicability of claims of a patent to different technologies may make an asset more valuable than a sales price. U.S. patents often are drafted in accordance with a commercial embodiment of a product/service or some specific idea that an inventor(s) has in mind. Yet, if prosecuted correctly, the claims of a patent may be broader in scope. Accordingly, another factor to help determine economics/value and use is the due diligence factor, e.g., assessing what the asset is and what it isn't.

Due diligence is loosely the analysis of the pros and cons of an asset. A proper and extensive due diligence analysis always should bring each and every potential issue to the forefront for the entity seeking the diligence. The ultimate goal of a due diligence analysis should be two-fold:

1. Determining any defendant's defenses, including finding the best art references a defendant might find; understanding how a child patent/application or parent patent/application in a family can impact an asset; and identifying the estoppel created not only in the underlying file history of the patent, but in foreign counterparts and related matters
2. Appreciating the economic impact such an IP asset could have on the entity or another entity. For example, a patent that covers an industry standard would have a higher economic impact for an entity, especially if the industry standard is one that the entity must abide by for its products/services. In other examples, claims of a patent may cover a competitor's product/service while not covering one for an acquiring entity. In such a case, the acquiring entity still may want to acquire the patent even though the entity itself would never be infringing the patent.

Many people believe that a due diligence analysis is merely a checklist of whether "X" was completed, or whether "Y" is "OK." A handy dandy checklist of all things due diligence is nice, but unrealistic since it is never a "yes or no" checklist. A proper due diligence analysis seeks to find error, properly construe claim language, establish prior art or other invalidity rejections, uncover inequitable conduct contentions, discern doctrine of equivalents arguments, check and recheck priority, and question inventorship. The reason is simple: Some errors are correctable either before or after a patent asset is acquired, while other errors are not.

Understanding the warts prior to acquisition drives the cost of the asset down. If an entity knows that an acquired asset will require additional post-grant prosecution to correct errors, the entity can push for a lower cost. The entity should also know that an asset needing reissue or reexamination can incur large clean-up costs. Yet the result may be an extremely defensible and highly enforceable asset. An example in today's IP environment is traditional computer-implemented method claims. Recent Supreme Court and Federal Circuit decisions have changed the computer-implemented method claims landscape dramatically. Past solutions of putting traditional manual operations in computer-readable medium formats are failing at the Supreme Court and Federal Circuit levels. Courts are finding that many of these claims are patent-ineligible subject matter. So, unless the claims of such a patent are corrected in reissue or reexamination, the patent itself may be economically useless.

An acquiring entity wants to know the potential rejections it faces in a reexamination proceeding or a litigation. An acquiring entity wants to know all of the issues and concerns with acquiring the asset and what will need to be done if acquired. An acquiring entity wants to know the results of this analysis before entering into any negotiation. A wart-ridden asset may cost substantial money to correct after acquisition, but also may be an economic factor in negotiating for a lower cost. Additionally, issues concerning inventorship, priority, ownership or similar subject matter can be raised and addressed in negotiation. A party selling an asset may be quick to respond to inquiries concerning such subjects but often are unresponsive after funding is in hand. Accordingly, knowing all of an asset's benefits and problematic issues before acquisition is the only real way to ensure a well-reasoned patent acquisition.



**John M. Fleming**

John M. Fleming is a principal shareholder in the Washington, D.C., office of Banner & Witcoff Ltd. He concentrates on preparing and prosecuting utility and design patent applications in a variety of technical fields while participating in litigation matters, client counseling, and opinion work.



**Performing Proper Diligence When  
Assessing IP Assets for Acquisition**

**John M. Fleming**

***Transaction Advisors***

**November 24, 2014**

## COLLECTIONS

ROLES TOPICS

- Board Members
- Chief Financial Officers
- Corporate Development
- Chief Risk Officers
- Chief Accounting Officers
- Private Equity Investors
- General Counsel
- Directors of Tax
- Business Owners
- Venture Capital Investors

## Performing Proper Diligence when Assessing IP Assets for Acquisition

Nov

2014

Due diligence during acquisitions that involve intellectual property (IP) is increasingly shifting to a qualitative review, according to this author.

Proper background checks in acquisition, whether for negotiation or defense purposes, aid in determining and appreciating what assets are really available.

The ultimate goal of a due diligence analysis should be two-fold: (1) find and understand how a child patent/application or parent patent/application in a family can impact an asset; and (2) identify the estoppel created not only in the underlying file history of the patent, but in foreign counterparts and related matters.



A proper due diligence analysis seeks to find error, properly construe claim language, establish prior art or other invalidity rejections, and question inventorship, among other things.

The reasoning behind such a thorough due diligence analysis is simple: some errors are correctable before a patent is acquired, while others are not.

Understanding the defects in an IP asset prior to acquisition can help lower the asset's cost. On the contrary, however, due diligence may result in a finding that the IP asset is extremely defensible and highly enforceable.

Due diligence can help acquiring entities discover the potential rejections it faces in a reexamination proceeding or a litigation and the issues and concerns with acquiring the asset and what will need to be done if the asset is acquired.

Importantly, acquirers should obtain answers to these inquiries prior to acquiring the IP asset.

While discovering defects in an IP asset during due diligence may quell excitement surrounding the asset, such defects can also serve as justification for lowering the price.

Sellers are often quick to respond to the above inquiries pre-sale, but can become non-responsive once the deal is done. Accordingly, knowing an asset's benefits and problematic issues before acquisition is recommended to ensure a well-reasoned patent acquisition.

*This article was originally published in Inside Counsel.*

[Full article](#)



Tags: Mergers & Acquisitions, IP Due Diligence, Intangible Asset Valuation

BY JOHN M. FLEMING, ESQ.





John Fleming is an Attorney in the Washington D.C. office of Banner & Witcoff, Ltd. He concentrates on preparing and prosecuting utility and design patent applications in a variety of technical fields while participating in litigation matters, client counseling, and a wide variety of opinion work.

[View all articles by John M. Fleming, Esq.](#)

#### ABOUT BANNER & WITCOFF, LTD.



Banner & Witcoff is dedicated to excellence in the specialized practice of intellectual property law, including patent, trademark, copyright, trade secret, computer, franchise and unfair competition law. The firm actively engages in the procurement, enforcement and litigation of intellectual property rights throughout the world, including all federal and state agencies, and the distribution of such rights through licensing and franchising.

[View all articles by Banner & Witcoff, Ltd.](#)



**“Do the Due”: Due Diligence  
Practices Geared Toward  
Potential Offensive Use (Part 2)**

**John M. Fleming**

***Inside Counsel***

**November 24, 2014**



## Inside Counsel

# “Do the Due”: Due diligence practices geared toward potential offensive use

Simply put: never acquire a patent like an ostrich with its head in the sand

By [John M. Fleming](#)

November 24, 2014

When a patent or patent portfolio offering becomes available for acquisition or, similarly, when a company is looking to acquire another entity that has intellectual property assets, some form of due diligence regarding the assets normally occurs. In many instances, the cost of acquisition of the entity with the IP assets is based upon the value of those assets. Companies may have physical resources and personnel, but their IP can often be the reason for the acquisition. In such circumstances, many companies looking toward acquisition for offensive use are not taking the necessary steps to verify the enforceability, and more importantly even, the outright ownership of the IP assets.

When looking to acquire a patent or patent portfolio for eventual offensive use, due diligence is needed and a proper due diligence is essential. Although it may sound completely counterintuitive, the main goal of the diligence project should be to invalidate the patent, to find the patent unenforceable, and/or to identify some other issue with the patent. The reason is actually quite simple. When Company A sues Company B on such a patent, Company A undoubtedly will face a similar response from Company B. A defending entity will argue non-infringement and invalidity, but it also will argue unenforceability and lack of standing. As part of the acquisition, the acquiring entity needs to know all issues, problems, irregularities and discrepancies associated with a patent. Possibly aside from non-infringement affirmative defenses, an acquiring company should address any possible defense that a defendant may proffer.

Conducting a validity analysis on a patent assists in negotiation. Determining whether the best prior art references were put before the U.S. Patent & Trademark Office (USPTO) for examination purposes and whether there are other prior art references more on point to the invention provides insight into the purported strength of the patent against an invalidity defense. An on point art reference dated after the filing date of the patent may not be a prior art reference, but it may provide information on other prior art references that existed. Often some of the best locations for prior art references are found in issued, pending or abandoned child applications. A continuation application that was subsequently abandoned may provide additional art references that were never before the examiner who examined the patent to be acquired. Those new prior art references may similarly affect the patentability of the patent to be acquired.

In similar contexts, the prosecution of foreign counterpart applications to the patent to be acquired can be fruitful sources of prior art references. Although the USPTO seems to take quite some time to issue patents, it often examines cases earlier than other foreign jurisdictions. A foreign counterpart to a U.S. application may not even be filed until a year after the U.S. application. In many cases, the U.S. application is examined and proceeds to issuance before the foreign counterpart is even examined. In such cases, a foreign patent office cites prior art references for rejection that were never presented before the U.S. examiner. Yet, validity analysis is but one piece of a proper diligence on an asset.

Not all mistakes associated with a patent are noticed by the USPTO during prosecution. Many mistakes are correctable with a small or sizeable fee. Yet, other mistakes are not correctable or have dramatic effects on term or enforceability. Take a claim of priority as one example. Under U.S. practice, an applicant can continuously claim new continuation after new continuation, resulting in a long priority chain. It is not uncommon to find a patent to be acquired that claims priority to three or more U.S. patents in a long chain. Yet, one of those earlier patents may be deemed a prior art reference to the patent to be acquired. A mistake in a priority claim in an intermediate patent in the chain effectively destroys the claim of priority thereafter in the chain. As such, an earlier version of the same disclosure by the same inventors could end up being a prior art reference for invalidity purposes. In other occurrences, statutory requirements may have been missed and the mistake simply may not have been caught by the patent office.

Imagine a patent family chain where one of the links in the chain is an application that was abandoned. Many people believe that an application becomes abandoned when the patent office issues a notice of abandonment. Yet, such a notice is merely a formal acknowledgement of the occurrence, not a date, and such a notice often follows weeks, if not months, after the actual statutory date of abandonment. Accordingly, the face of a patent to be acquired may show a chain of priority back to an earlier application/patent, yet the abandonment of a middle application in the chain effectively destroys the chain or priority to the first link. Now later art references are potentially in use for invalidity, including even the previous patents/applications in the family chain.

Still other factors should be taken into account for a proper diligence analysis. Previous litigation of the patent may find a settlement agreement between the parties. Such an agreement may include a license between parties. If a potential defendant only is infringing the patent due to the use of a product/service of that previous defendant in the now settled litigation, then the potential defendant may be indemnified from an infringement action.

Whether seemingly small or large issues, all issues should be identified and vetted. In the end, minor flags can be corrected even if requiring some fees. Major flags can be used to lower the acquisition price or walk away from the potential acquisition altogether. Simply put: never acquire a patent like an ostrich with its head in the sand.



**John M. Fleming**

John M. Fleming is a principal shareholder in the Washington, D.C., office of Banner & Witcoff Ltd. He concentrates on preparing and prosecuting utility and design patent applications in a variety of technical fields while participating in litigation matters, client counseling, and opinion work.



**Year-End Brings New Developments  
in Patent Eligibility**

**Ernest V. Linek**

***Banner & Witcoff Intellectual  
Property Alert***

**December 17, 2014**



## Intellectual Property Alert: Year-End Brings New Developments in Patent Eligibility

By Ernest V. Linek

December 17, 2014 – Section 101 of the Patent Act (35 U.S.C. 101) continues to be of concern for patent practitioners, patent applicants and patent owners. The language of this statute defines what constitutes patent eligible subject matter, as follows:

“Whoever invents or discovers any new and useful process, machine, manufacture, or composition of matter, or any new and useful improvement thereof, may obtain a patent therefor, subject to the conditions and requirements of this title.”

Using the statutory language as a guide, the courts and the United States Patent and Trademark Office (USPTO) have defined subject matter that is not eligible for patent protection. This is an update of that process.

### **USPTO Issues New Section 101 Guidelines for Patent Eligibility**

On December 16, 2014, the USPTO published its new “2014 Interim Eligibility Guidance on Patent Subject Matter Eligibility” in the Federal Register (79 Fed. Reg. 74618). In this document, the USPTO gives patent examiners instructions for analyzing patent claims for subject matter eligibility under 35 U.S.C. §101 with respect to the judicial exceptions to patent eligibility of “abstract ideas, natural phenomena, and products of nature.”

This version replaces the guidelines issued in March 2014 and updates those guidelines on the “product of nature exception” in light of the *Mayo* and *Myriad* decisions. The new guidelines also supplement the June 2014 guidelines regarding the “abstract idea exception” in light of the *Alice* decision.

The March guidelines were issued in response to the Supreme Court decisions in *Association for Molecular Pathology v. Myriad Genetics, Inc.*, 133 S. Ct. 2107 (2013) and *Mayo Collaborative Services v. Prometheus Laboratories, Inc.*, 132 S. Ct. 1289 (2012). The June guidelines were issued in response to the Supreme Court’s decision in *Alice Corporation Pty. Ltd. v. CLS Bank International*, 134 S. Ct. 2347 (2014).

The new guidelines provide an updated view of subject matter eligibility in line with *Alice Corp.*, *Myriad*, *Mayo*, and recent case law. The new guidelines also respond to the public comments received pertaining to the March and June versions.

One important note is that the new guidelines do not constitute substantive rulemaking and do not have the force and effect of law. The guidelines are merely provided to the examiners (and the public) to provide better understanding and implementation of Section 101 analysis of patent claims, particularly with respect to the provisions of MPEP Sections 2105, 2106 and 2106.01.

Another important note is that the new guidelines are not intended to create any right or benefit, substantive or procedural, enforceable by any party against the Office. Rejections will continue to be based upon the substantive law, and it is these rejections that are appealable. Failure of any USPTO personnel to follow the guidelines is not, in itself, a proper basis for either an appeal or a petition.

With respect to the “product of nature” guidance, the December guidelines are distinguished from the prior versions as follows:

1. separates the “product of nature” analysis from the “significantly more” analysis for overcoming the exception;
2. focuses on claims “directed to” a product of nature, rather than claims that merely “involve” a product of nature; and
3. uses a “markedly different” analysis of characteristics that can include a product’s structure, function, and/or other properties as compared to its naturally occurring counterpart in its natural state.

The new guidelines regarding nature-based products replace the prior set of explanatory examples with a new set of examples, and according to the Office, include many examples suggested in public comments.

The new guidelines include a decision-making flowchart with the following instructions for claim analysis under Section 101:

Prior to evaluating a claim for patentability, establish the broadest reasonable interpretation of the claim and analyze the claim as a whole when evaluating for patentability.

Step 1 – is the claim to a process, machine, manufacture or composition of matter?

If yes – go to Step 2A.

If no – the claim is not eligible subject matter under 35 U.S.C. §101.

Step 2A – (*Mayo* test – Part 1) – is the claim directed to a law of nature, a natural phenomenon, or an abstract idea (the judicially recognized exceptions to patentable subject matter)?

If no – the claim qualifies as eligible subject matter under 35 U.S.C. §101.

If yes – go to Step 2B

Step 2B (*Mayo* test – Part 2) – does the claim recite additional elements that amount to significantly more than the judicial exception?

If no – the claim is not eligible subject matter under 35 U.S.C. §101.

If yes – the claim qualifies as eligible subject matter under 35 U.S.C. §101.

Notable changes from prior guidelines include:

All claims (product and process) with a judicial exception (of any type) are subject to the same steps.

Claims including a nature-based product are analyzed in Step 2A to identify whether the claim is directed to (i.e., recites) a “product of nature” exception.

This analysis compares the nature-based product in the claim to its naturally occurring counterpart to identify markedly different characteristics based on structure, function, and/ or properties.

The analysis proceeds to Step 2B **only** when the claim is directed to an exception (i.e., when no markedly different characteristics are shown).

The new guidelines further explain the Section 101 claim analysis as follows:

1. Determine what the claim is “directed to.”
2. Identify the judicial exception recited in the claim.
3. Determine if recited nature-based product has characteristics “markedly different” from natural product.
4. Determine if the structure, function or other properties of the recited nature-based product are “markedly different” from natural product.
5. Determine if any element in the claim ensures that the claim is “significantly more” than the judicial exception.

According to the new guidelines, a claim is “directed to” a judicial exception when a law of nature, a natural phenomenon, or an abstract idea “is recited (i.e., set forth or described) in the claim.”

Claims that recite a judicial exception may nonetheless be patent eligible if they are “directed to inventions that clearly do not seek to tie up the judicial exception.” Included in the new guidelines is an extensive collection of examples to show what subject matter has been found either eligible or ineligible under Section 101.

The new guidelines became effective as of December 16, 2014, and apply to all applications filed before, on, or after that date.

Public comment is invited and must be received on or before March 16, 2014.

## **New Section 101 Case Law**

On December 17, 2014, the Federal Circuit, in the case of *University of Utah Research v. Ambry Genetics*, applied Section 101 against patent claims used by Myriad – that had previously not been reviewed by the court.

Four composition of matter claims directed to DNA primers were held to be ineligible subject matter, because they are directed to products of nature – citing the Supreme Court’s *Myriad* decision. The court’s basis for concluding that the primers are directed to “products of nature” was that they possess the same nucleotide sequence as the naturally occurring DNA.

In addition, two method claims were found to be ineligible subject matter because they were directed to abstract ideas based on the use of the DNA primers – citing the Supreme Court’s *Mayo* decision.

To subscribe or unsubscribe to this Intellectual Property Advisory,  
please send a message to Chris Hummel at [chummel@bannerwitcoff.com](mailto:chummel@bannerwitcoff.com)



[www.bannerwitcoff.com](http://www.bannerwitcoff.com)

© Copyright 2014 Banner & Witcoff, Ltd. All Rights Reserved. The opinions expressed in this publication are for the purpose of fostering productive discussions of legal issues and do not constitute the rendering of legal counseling or other professional services. No attorney-client relationship is created, nor is there any offer to provide legal services, by the publication and distribution of this edition of IP Alert.





**IP Due Diligence Practices Geared  
Toward Potential Offensive Use**

**John M. Fleming**

***Transaction Advisors***

**December 23, 2014**

## COLLECTIONS

ROLES TOPICS

- Board Members
- Chief Financial Officers
- Corporate Development
- Chief Risk Officers
- Chief Accounting Officers
- Private Equity Investors
- General Counsel
- Directors of Tax
- Business Owners
- Venture Capital Investors

## IP Due Diligence Practices Geared Toward Potential Offensive Use

Dec 2014

When an acquisition involves intellectual property, typically that intellectual property will be the chief element of both the buyer's motivation for purchasing and the transaction's overall price.

In such circumstances, the authors of this articles emphaizes taking the necessary steps to verify the enforceability, and more importantly, the outright ownership of the IP assets.

When looking to acquire a patent or patent portfolio for eventual offensive use, proper due diligence is essential.

Although counterintuitive, the main goal of the due diligence should be to invalidate the patent, to find the patent unenforceable, or identify other issues. Such an approach will generate a similar defense that the acquirer can expect if and when claims arise.

When looking for prior references to complete a validity analysis, these authors suggest searching issued, pending, or abandoned child applications.

Additionally, the prosecution of foreign counterpart applications to the patent to be acquired can be fruitful sources of prior art references.

Validity analysis is but one piece of proper diligence, however. Due diligence should uncover situations effecting a destruction of the claim of priority in a patent chain. While many such mistakes are correctable through the paying of a fee, other mistakes are not correctable or have dramatic effects on term or enforceability. Mistakes in a priority claim in an intermediate patent in the chain effectively destroys the claim of priority thereafter in the chain.

Another factor discussed in this article is the analization of previous litigation of the patent. This litigation may have led to a settlement between the parties that included license terms. A settlement agreement may include indemnification provisions to the benefit of any potential defendants as well.

This author encourages buyers to identify and vet all potential issues, large and small. In the end, minor flags can be corrected even if requiring some fees. Major flags can be used to lower the acquisition price or walk away from the potential acquisition altogether.

*This article was originally published in Inside Counsel.*

[Full article](#)



Tags: IP Due Diligence, Data Due Diligence, Defensive Assets, In-Process Research & Development, IT Due Diligence, Licensing Transactions, Mergers & Acquisitions



Industries: Biotechnology, Health Care Equipment & Supplies, Health Care Technology, Life Sciences Tools & Services, Pharmaceuticals, Communications Equipment, Electronic Equipment, Instruments & Components, Internet Software & Services, IT Services, Semiconductor Equipment & Products -- Discontinued effective 04/30/2003., Semiconductors & Semiconductor Equipment, Software, Technology Hardware, Storage & Peripherals, Diversified Telecommunication Services, Wireless Telecommunication Services

BY JOHN M. FLEMING, ESQ.



John Fleming is an Attorney in the Washington D.C. office of Banner & Witcoff, Ltd. He concentrates on preparing and prosecuting utility and design patent applications in a variety of technical fields while participating in litigation matters, client counseling, and a wide variety of opinion work.

[View all articles by John M. Fleming, Esq.](#)

ABOUT BANNER & WITCOFF, LTD.



Banner & Witcoff is dedicated to excellence in the specialized practice of intellectual property law, including patent, trademark, copyright, trade secret, computer, franchise and unfair competition law. The firm actively engages in the procurement, enforcement and litigation of intellectual property rights throughout the world, including all federal and state agencies, and the distribution of such rights through licensing and franchising.

[View all articles by Banner & Witcoff, Ltd.](#)



**“Do the Due”: Due Diligence  
Practices Geared Toward Defensive  
Protection (Part 3)**

**John M. Fleming**

***Inside Counsel***

**January 6, 2015**

## Inside Counsel

# “Do the Due”: Due diligence practices geared toward defensive protection

Knowing as many of the issues upfront allows a company to properly respond to an accusation in a timely and authoritative manner

By [John M. Fleming](#)  
January 6, 2015

*The third in a three-part series, also check out [how to perform proper diligence when assessing IP assets for acquisition](#) and these [due diligence practices geared toward potential offensive use](#).*

Whether a company receives a demand for compensation veiled in a seemingly pleasant cease and desist letter or an outright accusation of willful patent infringement to an extreme, the company is on notice. A patent owner often reaches out to companies to secure a licensing opportunity during the term of a patent. The owner may have any number of reasons to seek out the specific company, but the goal often enough is to be compensated for alleged infringement of the patent’s claims. An industry practicing patent owner may want to prevent other competitors from practicing the patent’s claims, while a non-practicing entity that owns a patent just wants to be compensated.

Initially, a company that is accused of patent infringement or asked to seek licensing rights in a patent should try to understand these two goals: the goal of the accusing entity and the goal of the company being accused. The initial correspondence from the accusing entity likely specifies some details of his or her end goal but likely doesn’t tell the whole story. A diligence analysis on the patent regarding its litigation history and licensing history often tells a larger story. Appreciating the results of a litigation, post-grant proceeding against the patent, and information concerning licensing entities may inform the company being accused not only of the strength of the patent being asserted, but also of the accuser. Financially strapped accusers and accusers that have seen a weakening of rights affiliated with their patent often tell an accused company about ulterior motives of an accuser or the underlying reasons for the accusation.

On the other side of the alleged infringement coin, appreciating the goals of the accused company is even more important. Although the end goal always is centered on mitigating any financial amount or goodwill damage, the analysis of a proper due diligence will streamline fulfillment of these goals and further provide the accused company valuable information in deciding how to take the next steps, whether fighting against the accuser, negotiating a license or even potential acquisition. A due

diligence analysis on the patent in some instances can even allow an accused company to step back to the negotiation table with enough of an initial strengthened response to make the accuser go away.

Often the ideal position for an accused company is to detail how it does not infringe the accuser's patent. And in cases of many accused products/services, a diligence result providing a non-infringement position ensures a best case scenario for an accused company. Yet, in today's marketplace, products and services change rapidly. New versions are released, new software or firmware packages are installed, or new operating procedures and/or manufacturing processes are employed on a regular basis. Yet a proper due diligence analysis in accessing a product for infringement will be limited to the specific product reviewed and perhaps even the specific date or time it was reviewed. Accordingly, additional positions always should be considered.



**John M. Fleming**

John M. Fleming is a principal shareholder in the Washington, D.C., office of Banner & Witcoff Ltd. He concentrates on preparing and prosecuting utility and design patent applications in a variety of technical fields while participating in litigation matters, client counseling, and opinion work.

# **POST-ISSUANCE PROCEEDINGS**



**Motion to Amend in *Inter Partes*  
Review Proceedings — A Quick  
Reference**

**Christopher L. McKee**

***IIPI/BBNA AIA Post-Grant Patent  
Practice Conference***

**February 19-20, 2014**



**MOTIONS TO AMEND IN *INTER PARTES* REVIEW  
PROCEEDINGS – A QUICK REFERENCE**

**IIPI/BBNA AIA POST-GRANT PATENT PRACTICE CONFERENCE**

**February 19-20, 2014**

**Christopher L. McKee, Banner & Witcoff, Ltd.**

**Statutory Basis:** 35 U.S.C. § 316(d).

**Rule:** 37 C.F.R. § 42.121.

**Guidance:** Office Patent Trial Practice Guide (OPTPG), 77 Fed. Reg. 48766-67.

**PTAB Decisions:** Some discussed below.

1) Board approach to motions to amend highly restrictive. THIS IS NOT LIKE REEXAMINATION.

2) Procedural Requirements/Limitations

a. Generally only one opportunity to move to amend claims.

i. To be filed no later than with Patent Owner Response Rule 42.121(a)(1).  
No opportunity to amend claims with Preliminary Response. Rule 42.107(d).

b. Must discuss motion to amend with Board in conference call in advance of filing. Rule 42.121(a).

c. Proposed claim amendments may be contingent or non-contingent -- to be clearly stated in motion. *Idle Free Systems, Inc. v. Bergstrom, Inc.*, IPR 2012-00027, Paper 26 at 10.

3) Substantive Requirements/Limitations

- a. Amendments may not enlarge the overall scope of the patent claims (same as in reexam). Rule 42.121(a)(2)(ii).
- b. Claim amendments must be responsive to unpatentability grounds asserted: “[A] proposed substitute claim is not responsive to an alleged ground of unpatentability of a challenged claim if it does not either include or narrow each feature of the challenged claim being replaced.” *Idle Free*, IPR2012-00027, Paper 26 at 5.
  - i. appears to prohibit broadening of a dependent claim within the scope of its original base claim (more restrictive than reexam).
- c. The permitted reasonable number of substitute claims (35 U.S.C. § 316(d)) means no more than a one for one substitution of an amended claim for each claim in trial, absent a demonstration of need. Rule 42.121(a)(3). Strictly applied.
  - i. “A desire to obtain a new set of claims having a hierarchy of different scope typically would *not* constitute a sufficient special circumstance. . . . If a patent owner desires a complete remodeling of its claim structure according to a different strategy, it may do so in another type of proceeding before the Office.” *Idle Free*, IPR2012-00027, Paper 26 at 6.
  - ii. No provision for alternative proposed amendments akin to European opposition proceedings.
  - iii. The one-for-one claim substitution limitation has been applied very restrictively: “If a proposed substitute claim includes all the features of an original patent claim, then it counts as a substitute claim for that original patent claim, regardless of the actual designation of substitution contained in the motion.” *ZTE Corp. v. Contentguard Holdings Inc.*, IPR 2013-00136, Paper 33 at 4. Here, the Board was addressing a situation

- where the Patent Owner sought to substitute claims for dependent claims to make those claims depend from a proposed substitute base claim. The limitation stated would seemingly preclude such changes of claim dependency absent a demonstration of special need for more than a one for one substitution of amended claims.
- d. Must demonstrate written description support for amendments in application as filed, **and** in any earlier application from which priority is sought. Rule 42.121(b).
    - i. Not enough to show support in patent as issued.
  - e. BURDEN IS ON PATENT OWNER TO PROVE PATENTABILITY OF AMENDED CLAIMS. Under *Idle Free*, IPR2012-00027:
    - i. Rule 42.20(c), addressing motions generally, provides the basis (“moving party has the burden of proof to establish that it is entitled to the requested relief.”) Paper 26 at 7; Paper 66 at 26 and 33.
    - ii. Need to show general patentability over prior art.
      - 1. “A patent owner should identify specifically the feature or features added to each substitute claim, as compared to the challenged claim it replaces, and come forward with technical facts and reasoning about those feature(s), including construction of new claim terms, sufficient to persuade the Board that the proposed substitute claim is patentable . . .” Paper 26 at 7; Paper 66 at 34.
    - iii. Not enough to establish patentability over prior art applied to original patent claims. Paper 66 at 33. Need to show patentability over prior art of record and the closest prior art known to Patent Owner. Paper 26 at 7; Paper 66 at 34.

- iv. Need to address what is known about the level of skill in the art, in terms of the ordinary creativity and skill set of one of ordinary skill in the art. This is to be done *with respect to each added feature*. Paper 66 at 33-34.
- v. Need to address whether the element/limitation relied upon in the amended claim is known in any context, and if it is, need address non-obviousness of use in context of claimed invention, i.e., “why it would not have been applicable to render [the claimed invention] obvious to one with ordinary skill in the art.” Paper No. 66 at 35-36.

f. Page limits are a significant constraint!

- i. 15 pages for a motion to amend. Rule 42.24(a)(v). Listing of substitute claims counts against the 15 page limit. *Synopsys, Inc. v. Mentor Graphics Corp.*, IPR 2012-00042, Paper 30.
- ii. Petitioner likewise has 15 pages for opposition (Rule 42.24(c)(2)), and can raise new evidence (e.g., prior art, declaration testimony) to show unpatentability of claims. OPTPG, 77 Fed. Reg. 48767.
- iii. Patent Owner gets only 5 pages for reply. Rule 42.24(c)(2) (strictly enforced).
  - 1. Board has refused a Patent Owner request for three additional pages to address six new references cited by Petitioner against amended claims. *Synopsys*, IPR2012-00042, Paper 39.

4) An Opportunity for the Patent Owner: The Office Patent Trial Practice Guide (OPTPG) expressly provides for requesting from the Board a “substantial identity” determination that may support an argument that proposed substitute claims found patentable are not subject to the doctrine of intervening rights:

- a. “When filing a motion to amend, a patent owner may demonstrate that the scope of the amended claim is substantially identical to that of the original

patent claim, *as the original patent claim would have been interpreted by a district court*. In such cases, a patent owner may request that the Board determine that the amended claim and original patent claim are substantially identical within the meaning of 35 U.S.C. 252”. (OPTPG, 77 Fed. Reg. 48766; emphasis added)

\* \* \* \* \*



**Standard for Amending Claims in  
IPR May Need to Change**

**Christopher L. McKee**

***Law360 Expert Analysis***

**March 13, 2014**



---

Portfolio Media, Inc. | 860 Broadway, 6th Floor | New York, NY 10003 | [www.law360.com](http://www.law360.com)  
Phone: +1 646 783 7100 | Fax: +1 646 783 7161 | [customerservice@law360.com](mailto:customerservice@law360.com)

---

## Standard For Amending Claims In IPR May Need To Change

Law360, New York (March 13, 2014, 1:08 PM ET) -- The Idle Free decision<sup>[1]</sup> denied the patent owner's motion to amend claims on the ground that the patent owner had not proven the patentability of the claims over the prior art. Remarkably, the decision makes no reference to the petitioner's proofs on the issue, but rather denies the motion solely on the basis of perceived deficiencies in the patent owner's showing of patentability. Under Idle Free, not only is the burden on the patent owner to prove patentability of its amended claims, but "general patentability over prior art" must be demonstrated.

The Patent Trial and Appeal Board routinely cites to Idle Free as setting forth the standard for a motion to amend in an inter partes review. Many believe that the requirements for a motion to amend as articulated in Idle Free are extreme and very difficult, if not impossible, to satisfy. At present, the author is unaware of any decision by the board granting a motion to amend, other than one merely canceling claims. A patent owner's opportunity to amend its claims in an IPR may be hampered to such an extent that due process concerns may be raised. It appears questionable whether the procedure is consistent with the enacting statute.

In Idle Free, the patent owner Bergstrom represented in its motion to amend that the closest prior art was the prior art addressed in the IPR. The patent owner explained how the amended claims were patentably distinguished over this prior art. The board agreed, but held that it was insufficient to show patentability over just the references applied in the IPR.

The board required that the patent owner describe the level of skill in the art, in terms of the skill set and ordinary creativity of one of ordinary skill in the art. Reasonable enough. It is other aspects of the decision that give rise to concern.

The board held that the patent owner has the obligation to distinguish not only the prior art of record, but the prior art in general (that the patent owner knows about). According to the board, this means that the patent owner is required to address whether the features added by amendment were known in any context, and if so, why those features would not have been obvious in the context of the claimed invention.

Some believe that the board's approach in Idle Free is problematic, not just because it requires the patent owner to prove a negative (the nonexistence of invalidating prior art), but because of the lengths it appears to require a patent owner to go to in raising and then distinguishing prior art — within highly constrained briefing. The test announced raises concern also because it is seemingly arbitrarily variable based upon what the patent owner may or may not know about the relevant prior art.

In a switch from patent prosecution and litigation, the board has placed the burden upon

the patent owner to show patentability of amended claims over the prior art. Its rationale for this is that an IPR is an adjudicative rather than examinational proceeding.[2] The board is not in a position to "examine" patent claims as a patent examiner does in patent prosecution or re-examination.

The board also points to its rule that for any motion in an IPR, the movant is required to show that it is entitled to the relief requested.[3] But neither of these rationales justifies the demanding Idle Free approach. The extreme burdens placed upon the patent owner are unnecessary for the board to avoid having to "examine" claims to ascertain their patentability. In a modified approach proposed below, the patent owner may reasonably be deemed to have established entitlement to the relief requested with its motion to amend without satisfying all of the Idle Free requirements.

## **Proof of a Negative**

Initially, it is notable that the board's approach of placing the burden on the patent owner to prove the patentability of its amended claims is novel procedurally under U.S. patent law. In original prosecution and re-examination, one is deemed entitled to a patent in the absence of a showing of unpatentability. In litigation, a patent claim is presumed valid until proven invalid.

As mentioned, the board cites to its Rule (42.20(c)) as a basis for placing the burden of proving the patentability of amended claims on the patent owner.[4] This rule, addressing motions generally, provides that a "moving party has the burden of proof to establish that it is entitled to the relief requested." However, it appears at least arguable that such an application of the rule to motions to amend is contrary to the enacting statute. 35 U.S.C. § 316(e) provides: "Evidentiary Standards — In an inter partes review instituted under this chapter, the petitioner shall have the burden of proving a proposition of unpatentability by a preponderance of the evidence." No distinction is drawn here between original patent claims and proposed amended claims.

It is not unheard of for the law to impose upon a party the burden of proving a negative. For example, the plaintiff in a negligence action may be required to show an absence of due care on the defendant's part. However, even assuming that it is statutorily permissible to place the burden to prove patentability of amended claims on the patent owner, arguably the burden to prove a negative should not be imposed where proof of the negative in question (here, the nonexistence of any invalidating prior art) is impractical for the party bearing the burden in the proceeding, and where the opposing party (here, the petitioner) is in a much better position to prove the opposite (the existence of invalidating prior art).

## **Unfairness**

The board's approach in Idle Free appears to have the potential to result in arbitrary unfairness. By requiring the patent owner to address the prior art known to it, the Idle Free standard would seemingly discriminate against patent owners having knowledge of a large amount of relevant prior art, versus those having knowledge of little prior art.

In both complex and simple technologies, it would not be unusual for hundreds of relevant prior art references to exist. One might ask: Why should the patent owner with a vast awareness of all those references have a burden to patentably distinguish over them all, whereas a patent owner with much less extensive knowledge would have a commensurately lesser burden?

Idle Free critics also observe that there is potential unfairness because the patent owner has no reasonable basis for determining just how far it has to go in explaining away known



prior art references. By the directive of *Idle Free*, it is insufficient for the patent owner to only address the references in the relevant art. Rather, the patent owner must go further to explain away prior art applications of features added by amendment in other contexts.

Critics are concerned that it could often be impractical to expect the patent owner to show patentability to the extent required by *Idle Free*. For example, it would not be uncommon for the prior art of record, and prior art otherwise known to the patent owner, to include 10, 50, 100 or more arguably relevant references. Preparing an explanation of how the proffered claim amendments distinguish over all such art could be an enormous undertaking.

In a typical case, a feature added by amendment may be known in many different contexts. *Idle Free*'s requirement that the patent owner address the existence of added features in applications outside the field of invention compounds the patent owner's burden.

And to what benefit? The board emphasizes the importance of "convergence" in its trial proceedings, that is, the rapid narrowing of issues in the course of the trial.[5] To require the patent owner to raise and knock down an indeterminate number of straw men fails to focus on the key issues, and thus would seem to run contrary to this objective.

The patent owner's task in complying with the *Idle Free* standard is rendered all the more difficult by the strict briefing limitations imposed by the board. Only 15 pages are permitted for a motion to amend, inclusive of the listing of proposed substitute claims.[6] Fourteen-point font is required, as is double spacing.[7] In many cases, it may be unrealistic to expect the patent owner to be able to prove the patentability of amended claims over the prior art in general within such constraints. Due process concerns could thus be raised.

## **A Better Approach?**

An approach that would give the patent owner a fairer opportunity to amend its claims, while furthering the board's objective to maintain a streamlined, adjudicative (nonexaminational) proceeding, would be an improvement. Granted, the board should not be put in a position of having to examine amended claims to ascertain their patentability. It need not be, given the presence of the petitioner who is in the best position to bring forward arguments against patentability. This dynamic is at the heart of the adjudicative/adversarial model adopted for trials conducted before the PTAB.

Setting aside the issue of whether placing the burden on the patent owner to prove the patentability of its amended claims comports with the enacting statute, in the author's view, there is a more practical and fair approach that the board could take.

The approach would be to require the patent owner to initially establish the patentability of the claims over the prior art applied in the trial to the corresponding original claims. Upon doing so, the burden of production would be deemed shifted to the petitioner to rebut the arguments of patentability (with, as is currently permitted, the opportunity to introduce new evidence).

This makes sense since the petitioner, as the adverse party, is generally in a much better position to raise meritorious unpatentability grounds regarding amended claims, than is the patent owner to address the patentability of amended claims over some indeterminate universe of known prior art.

Presented with such patent owner arguments and evidence, and the petitioner's opposing arguments and evidence, the board would be well situated to decide whether, on balance,

the patent owner has met its burden to prove patentability of the amended claims by a preponderance of the evidence. Absent countervailing arguments, a patent owner's persuasive showing that the amended claims patentably distinguish over the prior art applied in the trial to the corresponding original claims would be deemed sufficient to satisfy the patent owner's burden to establish entitlement to the relief requested with its motion to amend.

—By Christopher L. McKee, Banner & Witcoff Ltd.

*Christopher McKee is a principal shareholder in Banner & Witcoff's Washington, D.C., office.*

*The opinions expressed are those of the author(s) and do not necessarily reflect the views of the firm, its clients, or Portfolio Media Inc., or any of its or their respective affiliates. This article is for general information purposes and is not intended to be and should not be taken as legal advice.*

[1] Final Written Decision entered Jan. 7, 2014 in *Idle Free Systems Inc. v. Bergstrom Inc.*, IPR 2012-00027, Paper 66 (PTAB).

[2] *Idle Free*, IPR 2012-00027, Paper 66 at 33.

[3] *Id.*; 37 C.F.R. § 42.20(c).

[4] *Idle Free*, IPR 2012-00027, Paper 26 at 7; Paper 66 at 26 and 33.

[5] See, e.g., *Idle Free*, IPR 2012-00027, Paper 26 at 4 (“The Board seeks to streamline and converge issues at all phases of the proceeding.”).

[6] 37 C.F.R. § 42.24(a)(1)(v); *Synopsys Inc. v. Mentor Graphics Corp.*, IPR 2012-00042, Paper 30 (PTAB).

[7] 37 C.F.R. § 42.6(a)(2).

---

All Content © 2003-2014, Portfolio Media, Inc.



**Five Considerations When Choosing  
How to Challenge Patent Validity**

**H. Wayne Porter and Craig W.  
Kronenthal**

***Banner & Witcoff Intellectual  
Property Update***

**April 21, 2014**

# UPDATE

SPRING/SUMMER 2014

## IN THIS ISSUE

- 1 Five Considerations When Choosing How to Challenge Patent Validity
- 4 The Google Books Case – Here's the Skinny
- 7 Aesthetic Functionality in the TTAB since *Louboutin*
- 10 IP Decisions Abound at the Supreme Court in Spring 2014
- 17 Global PPH and IP5 – Latest Iteration in the Patent Prosecution Highway

## FIVE CONSIDERATIONS WHEN CHOOSING HOW TO CHALLENGE PATENT VALIDITY



BY: H. WAYNE PORTER AND CRAIG W. KRONENTHAL

*Inter partes* review

(IPR) is quickly becoming a popular

choice for challenging the validity of a patent. The America Invents Act (AIA) established IPR as a mechanism for challenging patent validity through an evidentiary proceeding before the Patent Trial and Appeal Board (PTAB) of the U.S. Patent and Trademark Office (USPTO). Under the right circumstances, an IPR may be a viable option for a party seeking to challenge an issued patent. Other options include traditional *ex parte* reexamination and district court litigation. This article discusses five areas to consider when choosing the best option in a particular case.

### DISCOVERY

A third party requesting *ex parte* reexamination of a patent will have no real discovery opportunities. For example, *ex parte* reexamination does not allow a third party requestor to depose experts or other parties from whom a patent owner may submit declarations in support of patentability.

On the other hand, litigation allows for a broad scope of discovery. Rule 26(b) of the Federal Rules of Civil Procedure permits discovery so long as it “appears reasonably calculated to lead to the discovery of admissible evidence.” As a result, the discovery process often becomes a lengthy and costly component of litigation. Indeed, some believe that the discovery process is used to drive up expenses and consume resources in hopes of forcing opponents into a settlement.

Discovery in an IPR lies somewhere between these two extremes. Discovery is available in an IPR; however, it is quite limited in scope.<sup>1</sup> The IPR rules establish the right to cross-examine a declarant and require the parties to share information that is inconsistent with their positions.<sup>2</sup> For additional discovery, parties must reach an agreement or seek additional discovery by motion if agreement cannot be reached. Thus far, motions to the PTAB for additional discovery have been overwhelmingly unsuccessful. Parties have had difficulty persuading the PTAB that additional discovery is necessary in the “interest of justice,” and the PTAB has often noted that the time constraints of the IPR process do not allow for additional discovery.<sup>3</sup>

[MORE ►](#)

<sup>1</sup> See *Garmin Int'l Inc. v. Cuozzo Speed Techs. LLC*, IPR2012-00001, Paper 26 (March 5, 2013) (noting the significant difference between the scope of discovery in an IPR and litigation).

<sup>2</sup> 37 C.F.R. § 42.51(b).

<sup>3</sup> See e.g., *Apple Inc. v. Achatz Reference Publishing, Inc.*, IPR 2013-00080, Paper 17 (April 3, 2013).

## CLAIM AMENDMENTS

One of the largest factors weighing against challenging a patent through *ex parte* reexamination is the ability of the patent holder to amend the claims. In *ex parte* reexamination, the patent holder may add and amend claims to improve its position. The only restrictions are that the amended or new claims must be supported by the original application and must be narrower in scope than the issued patent claims. The only limit on the number of new claims that may be added is the patent owner's willingness to pay extra claim fees. In practice, many patent holders use reexamination as an opportunity to amend or add claims that more clearly cover an allegedly infringing product. Although new or amended claims only have prospective effect, they can still be quite valuable if the reexamined patent has a significant remaining term. Indeed, some patent holders request *ex parte* reexamination of their own patent to solidify the patent by adding and/or amending claims to improve position in preparation for litigation.

Patent claims cannot be amended during district court litigation. For this reason, parties seeking to invalidate a patent have previously chosen to forego reexamination and solely pursue litigation.

Patent claims can be amended during an IPR. However, the ability to amend claims in an IPR is quite limited. Like reexamination, claims may not be amended to enlarge the scope of protection in an IPR.<sup>4</sup> In addition, claim amendments must be in response to a ground of unpatentability involved in the IPR.<sup>5</sup> When the patent holder amends a claim, the petitioner (the party that requested the IPR) may argue that the amendment represents a concession that an amendment is needed to overcome a reference. Patent holders may thus be reluctant to amend.

Further, 37 C.F.R. § 42.121(a)(3) limits patent holders to a reasonable number of substitute claims in an IPR. The rule creates a presumption of a one-for-one paradigm in which one claim can be added when one claim is canceled. On a more practical level, applicable IPR page limits restrict the ability of a patent owner to make amendments. Amendments are made through a motion to amend, which is limited under 37 C.F.R. § 42.24(a)(1)(v) to 15 pages. The motion must include a claim listing, a discussion of support for added or amended claims, and how the amended claims distinguish over the asserted prior art. It can be difficult to squeeze all of this into 15 pages if there are more than a few new or amended claims. Although the IPR rules allow patent owners to request additional pages, the PTAB has been quite willing to reject such requests.<sup>6</sup>

## TIME

The timeframes for district court litigation vary widely. Some venues are considered "rocket dockets," but it is nonetheless common for patent litigation to last several years. *Ex parte* reexamination is generally considered to be faster, though this is not always the case. On average, the pendency of an *ex parte* reexamination from request filing date to certificate issue date is 27.9 months.<sup>7</sup>

An IPR is likely to be more expedient than *ex parte* reexamination or litigation. The PTAB is required to decide whether to institute an IPR within six months from the filing of a petition for an IPR. The PTAB is also required to reach a decision within 12 months from the time the IPR is instituted.<sup>8</sup> This deadline is extendable to 18 months upon a showing of good cause.

## MOTIONS

Motions are not a part of *ex parte* reexamination. Once a third party files a request for reexamination, that party may have no opportunity to participate in or influence

<sup>4</sup> 37 C.F.R. § 42.121(a)(2)(ii).

<sup>5</sup> 37 C.F.R. § 42.121(a)(2)(i).

<sup>6</sup> See *Idle Free Sys., Inc. v. Bergstrom, Inc.*, CBM2012-00027, Paper 27 (June 18, 2013).

<sup>7</sup> *Ex Parte* Reexamination Filing Data – Sept. 30, 2012 (www.uspto.gov).

<sup>8</sup> 37 C.F.R. § 42.100(c).

the outcome of the reexamination proceedings. The third party requestor is limited to a single reply if the patent owner responds to the request for reexamination. In practice, many patent owners do not respond to requests for reexaminations so that they can deprive third party requestors of that reply. Moreover, the third party is prohibited from communicating with the reexamination examiner, whereas patent holders are allowed to participate in interviews with the examiner.

Litigation generally stands at the other extreme in this area, as well. A wide variety of motions may be filed in district court litigation. Individual courts have their own local rules governing motion practice. Such local rules may dictate page limits, content requirements, deadlines for filing and responding, and how motions are to be filed (e.g., whether motions need to be electronically filed). Often local counsel is employed to ensure that the local rules are being met.

Although motion practice is also a component of IPRs, it is much more tightly controlled relative to district court litigation. For example, 37 C.F.R. § 42.20(b) requires prior PTAB authorization before filing a motion. Filing a motion without PTAB approval could result in expungement of the motion with prejudice.<sup>9</sup> This aspect can impact costs and expediency of IPRs. Although it is too early to reach conclusions, this pre-authorization requirement can be expected to cut down on the number of motions filed and keep motions narrowly tailored to specific issues. When authorizing motions, for example, the PTAB often provides guidance on the issues to be addressed in the motion.

## SETTLEMENT

Once a request for *ex parte* reexamination is granted and a reexamination is ordered, neither the patent owner nor a third party requestor can stop the reexamination.<sup>10</sup> The USPTO will reexamine the patent and allow and/or reject

claims regardless of any subsequent settlement or other agreement between the patent owner and the third party. It may thus be difficult for a third party to negotiate a favorable license while a patent is under reexamination, as the patent owner will have to continue fighting for patent validity regardless of whether a dispute with the third party requestor is resolved.

In contrast, the time, money and resources associated with district court litigation often motivate parties to settle. Indeed, most patent suits terminate as a result of settlement. When patent suits do settle, the settlement terminates the trial and the terms of settlement can often be kept confidential. The assurance that the terms of settlement will be kept confidential can be an influential factor in the willingness of a patent owner or patent challenger to settle.

Settlement considerations may play into whether a party chooses to institute an IPR. Unlike *ex parte* reexamination, the PTAB may terminate an IPR without reaching a decision.<sup>11</sup> However, 37 C.F.R. § 42.74 makes clear that the PTAB does not have to terminate the trial if the parties settle. The PTAB's decision to terminate the IPR proceedings will likely hinge on the timing of the settlement and how close the PTAB is to making a decision. As for the terms of settlement, 37 C.F.R. § 42.74(c) provides for keeping settlement details secret and separate from the file of the IPR. However, the same rule also provides for making such details available to government agencies on written request and to other persons upon a showing of good cause.

## CONCLUSION

As evidenced by the five areas discussed herein, all three options for challenging patent validity have benefits and drawbacks. The best option will depend on the particular circumstances at hand. The above aims to provide some guidance in light of the new IPR process when preparing a strategy for invalidating an issued patent. ■

An IPR is likely to be more expedient than *ex parte* reexamination or litigation.

<sup>9</sup> See *Bloomberg Inc. v. Markets-Alert Pty. Ltd.*, CBM2013-00005, Paper 15 (Dec. 3, 2012).

<sup>10</sup> An *ex parte* reexamination proceeding concludes with the issuance of a reexamination certificate (whether claims are allowed, canceled or amended). See 37 C.F.R. § 1.570.

<sup>11</sup> 37 C.F.R. § 42.72.



**PTAB Continues Hard Line on  
Motions for Additional Discovery,  
Door Left Open for Some Limited  
Discovery**

**Christopher L. McKee**

***Banner & Witcoff PTAB Highlights***

**August 28, 2014**

BANNER&WITCOFF

# PTAB HIGHLIGHTS

New developments in post-issuance proceedings

[bannerwitcoff.com](http://bannerwitcoff.com)

## PTAB Continues Hard Line on Motions for Additional Discovery, Door Left Open for Some Limited Discovery

By Christopher L. McKee

August 28, 2014 – The PTAB continues to take a hard line on motions for additional discovery, but shows a willingness to grant some limited additional discovery, as the following four decisions illustrate:

[IPR2014-00312 – Square, Inc. v. REM Holdings 3, LLC \(Paper 20\)](#)

The Patent Owner’s motion for additional discovery relating to evidence of secondary considerations to overcome obviousness challenges was dismissed without prejudice. The Board ruled that the motion contained both unduly broad and burdensome requests and also requests for information that was publically available. However, the Board did leave the door open to granting a “limited amount of discovery” to the Patent Owner because the Patent Owner “made sufficient showing to entitle them to some information from Petitioner regarding sales figures.” Although the Patent Owner has to demonstrate “more than a possibility or mere allegation that something useful will be found” from its discovery request, “this does not mean that the requester must prove conclusively that they will win on the merits before any discovery will be granted.”

[CBM2014-00131, 00133, 00135, 00136, 00137 – TD Ameritrade Holding Corp., et al. v. Trading Technologies International, Inc. \(Paper 11\)](#)

In these cases, the Patent Owner filed a request for authorization to file a motion for additional discovery as to whether Petitioner, an entity called eSpeed, and other unnamed parties were real-parties-in-interest to the IPR. The motion authorization request was denied. Separately, the



Board provided guidance regarding how to ensure compliance with “routine discovery” requirements.

The principal support proffered for the motion was a 2005 memo authored by counsel for eSpeed and obtained by Petitioner in 2010 in response to a “request for prior art,” after Petitioner was sued by the Patent Owner. Petitioner cited the 2005 memo in its CBM Petition and stated that it might contain attorney work product.

Under 37 C.F.R. § 42.224, additional discovery may be granted upon “a showing of good cause as to why the discovery is needed.” The Board decided that Patent Owner’s rationale for this additional discovery did not meet this threshold but rather amounted to “mere speculation that [Patent Owner] will discover information regarding an alleged joint defense group between Petitioner, eSpeed, and other unnamed entities.”

The Patent Owner also alleged that Petitioner improperly failed to serve a document which contained statements inconsistent with its petition. Patent Owner sought guidance from the Board as to how it could enforce compliance with routine discovery rules. Without stating whether Petitioner should or should not have served the document on Patent Owner, the Board directed Patent Owner to the language of 37 C.F.R. § 42.51(b)(1)(iii) addressing “routine discovery.” The Board concluded that Patent Owner “was free to address the alleged inconsistent statements in its Preliminary Response or Patent Owner Response.” The Board quoted from its Decision in *Garmin* (IPR2012-00001, Paper 26): “Routine discovery under 37 C.F.R. § 42.51(b)(1)(iii) is narrowly directed to specific information *known to the responding party to be inconsistent* with a position advanced by that party in the proceeding, and not broadly directed to any subject area in general within which the requesting party hopes to discover such inconsistent information.”

IPR2014-00199 – Wavemarket Inc. d/b/a/ Location Labs v. Locationet Systems LTD (Paper 34)

Here, the Patent Owner filed a motion for additional discovery requesting production of documents, an answer to an interrogatory, and authorization to take a deposition, which the Board denied. Patent Owner’s purpose was to establish parties as real parties in interest to the IPR on the basis that they were accused of infringing the patent at issue in multiple related district court litigations, and because each has a “direct interest in the outcome of this proceeding and a relationship with Petitioner.”

Patent Owner sought discovery of various indemnification agreements and joint defense/common interest agreements, communications, payments or payment obligations between Petitioner and the other parties which Patent Owner alleged are relevant to show the other parties’ involvement in and/or funding of the current IPR.

The Board focused on two of the five factors from *Garmin* (IPR2012-00001, Paper 26) to determine whether the additional discovery requests satisfied the “necessary in the interest of justice” standard under 35 U.S.C. § 3126(a)(5) - whether the requests were overly burdensome to answer and whether more than a mere possibility and mere allegation existed that would lead to useful discovery. Although Patent Owner’s evidence of shared counsel and the existence of the

indemnification and defense/common interests might uncover the existence of something useful that would support a finding of privity with Petitioner (which is a more expansive notion), such evidence is not sufficient to support a finding that the parties were real-parties-in-interest. Therefore, Patent Owner's evidence did "not demonstrate *beyond speculation* that something useful will be uncovered regarding [the other parties'] funding, direction, control, or ability to exercise control of Petitioner's participation in this *inter parte* review."

Furthermore, the Board determined that the document requests were unduly burdensome because they sought all communications about indemnification and regarding the joint defense and/or common interest agreements between Petitioner and AT&T, T-Mobile, and Sprint "without providing any basis that the requested communications contain any useful information."

IPR2014-00367 – Schott Gemtron Corp. v. SSW Holding Co., Inc. (Paper 20)

In this case, the Patent Owner was seeking additional discovery "pertaining to its assertion of commercial success and copying as secondary considerations of nonobviousness." Specifically, Patent Owner sought documents sufficient to identify Petitioner's total annual sales of certain products. The Board focused on the factor from *Garmin* (IPR2012-00001, Paper 26) which states that something more than a mere possibility of finding something useful is necessary in the interest of justice. Commercial success usually is demonstrated with evidence of "significant sales in a relevant market." Patent Owner's evidence of Petitioner's sales figures for the product in question (hydrophobic spill proof shelves) for 2013 was not sufficient to show "beyond mere speculation or a mere possibility, that Petitioner's sales were significant enough in the relevant market to constitute commercial success and that the requested discovery would, therefore, return useful information."

Furthermore, Patent Owner failed to establish a proper nexus between the claimed invention and the commercial success of the product. This would require proof that commercial success was a direct result of the unique characteristics of the claimed invention, as opposed to an unclaimed feature of the invention or other unrelated commercial and economic factors unrelated to the quality of the patented invention. Royalty reports showing purchases of hydrophobic spill proof shelves do "not point out sufficient evidence of nexus between the claimed invention and Petitioner's product *with respect to Petitioner's sales*." A declaration testifying that Patent Owner's design was the reason a party bought shelves from the Patent Owner was "not indicative of reasons for buying from the Petitioner. Without evidence of a nexus regarding Petitioner's sales, Patent Owner could not demonstrate that its discovery requests would be likely to uncover something useful.

*The Leahy-Smith America Invents Act established new patent post-issuance proceedings, including the inter partes review, post grant review and transitional program for covered business method patents, that offer a less costly, streamlined alternative to district court litigation. With the U.S. Patent and Trademark Office's Patent Trial and Appeal Board conducting a large and increasing number of these proceedings, and with the law developing rapidly, Banner & Witcoff will offer weekly summaries of the board's significant decisions and subsequent appeals at the U.S. Court of Appeals for the Federal Circuit.*



[www.bannerwitcoff.com](http://www.bannerwitcoff.com)

© Copyright 2014 Banner & Witcoff, Ltd. All Rights Reserved. The opinions expressed in this publication are for the purpose of fostering productive discussions of legal issues and do not constitute the rendering of legal counseling or other professional services. No attorney-client relationship is created, nor is there any offer to provide legal services, by the publication and distribution of this edition of PTAB Highlights.



**Voluminous Declaration Leads to  
PTAB Denial of IPR Petition**

**Christopher L. McKee**

***Banner & Witcoff PTAB Highlights***

**August 28, 2014**

BANNER&WITCOFF

# PTAB HIGHLIGHTS

New developments in post-issuance proceedings

[bannerwitcoff.com](http://bannerwitcoff.com)

## Voluminous Declaration Leads to PTAB Denial of IPR Petition

By Christopher L. McKee

August 28, 2014 – In a decision of interest, the PTAB denied institution of *inter partes* review due to the Petitioner’s excessive reliance on a voluminous supporting declaration:

[IPR2014-00491 – Fidelity National Information Services, Inc. v. Datatransaction Corp. \(Paper 9\)](#)

In this decision denying institution of an *inter partes* review, the Board refused to consider information contained in a supporting declaration, but not sufficiently presented in the petition itself. Under 37 C.F.R. § 42.22(a)(2) a petition must include a “full statement of the reasons for the relief requested, including a detailed explanation of the significance of the evidence....” Here, Petitioner submitted a claim-by-claim analysis for nine grounds of unpatentability, alleging the prior art teaches or suggests each element of the claim. Petitioner chiefly cites to a 287 page declaration containing 1,278 paragraphs. In those paragraphs, the declarant points “almost exclusively to a 1,003 page, single-spaced, claim chart in landscape format appended to [the] Declaration as Exhibit A.” The claim chart then cites to the references themselves. Through this three-level incorporation technique – the petition incorporating the declaration, the declaration incorporating the claim chart, and the claim chart incorporating from the references – the Petitioner impermissibly sought to greatly expand its arguments in support of the petition.

The Board ruled that the “petition’s extensive reliance on citations to the ... Declaration in lieu of citations to the references themselves amounts to an incorporation by reference of arguments made in the ... Declaration into the Petition, thereby circumventing the page limits that apply to petitions.” The Board refused to consider the information found only in the declaration. Arguments made in a supporting document may not be incorporated by reference into a petition, pursuant to 37 C.F.R. § 42.6(a)(3).

*The Leahy-Smith America Invents Act established new patent post-issuance proceedings, including the inter partes review, post grant review and transitional program for covered business method patents, that offer a less costly, streamlined alternative to district court litigation. With the U.S. Patent and Trademark Office's Patent Trial and Appeal Board conducting a large and increasing number of these proceedings, and with the law developing rapidly, Banner & Witcoff will offer weekly summaries of the board's significant decisions and subsequent appeals at the U.S. Court of Appeals for the Federal Circuit.*



[www.bannerwitcoff.com](http://www.bannerwitcoff.com)

© Copyright 2014 Banner & Witcoff, Ltd. All Rights Reserved. The opinions expressed in this publication are for the purpose of fostering productive discussions of legal issues and do not constitute the rendering of legal counseling or other professional services. No attorney-client relationship is created, nor is there any offer to provide legal services, by the publication and distribution of this edition of PTAB Highlights.



**PTAB Dismisses Argument That  
Priority Date is a § 112 Issue Not  
Reviewable in an IPR**

**Craig W. Kronenthal**

***Banner & Witcoff PTAB Highlights***

**September 3, 2014**

BANNER&WITCOFF

# PTAB HIGHLIGHTS

New developments in post-issuance proceedings

[bannerwitcoff.com](http://bannerwitcoff.com)

## PTAB Dismisses Argument That Priority Date is a § 112 Issue Not Reviewable in an IPR

By Craig W. Kronenthal

September 3, 2014 — In a decision instituting *inter partes* review, the PTAB rejected a patent owner's argument that the priority date of the patent is not reviewable in an IPR because it's an issue under 35 U.S.C. § 112.

IPR2014-00414 – SAP America, Inc. v. Pi-Net International, Inc. (Paper 11, August 18, 2014)

An IPR petition was filed to challenge a patent that is a divisional of and claims priority to an earlier filed parent application. The petition challenged the priority date of the patent, and asserted unpatentability based in part on a published U.S. patent application that was filed after the claimed priority date. The petitioner argued that certain negative limitations in the claims of the patent were not supported by the parent application. In its preliminary response, the Patent Owner did not address whether the claims were supported. Instead, the Patent Owner simply argued that the priority issue is a question of compliance with the written description requirement of 35 U.S.C. § 112 and cannot be considered in an *inter partes* review in which patentability challenges are limited to challenges under 35 U.S.C. §§ 102 and 103. *See* 37 C.F.R. § 42.104(b)(2).

The Board disagreed, noting “the difference between compliance with the requirements of 35 U.S.C. § 112 and assessing the earliest priority date for a claim.” The Board pointed out that the Petitioner is not impermissibly challenging the patentability of the patent under 35 U.S.C. § 112, but rather is simply challenging the priority date. The Board was persuaded that the claimed features were not entitled to the priority date. The Board went on to consider the challenge under 35 U.S.C. § 103 relying on the intervening reference, and ultimately decided to institute the *inter partes* review.



*The Leahy-Smith America Invents Act established new patent post-issuance proceedings, including the inter partes review, post grant review and transitional program for covered business method patents, that offer a less costly, streamlined alternative to district court litigation. With the U.S. Patent and Trademark Office's Patent Trial and Appeal Board conducting a large and increasing number of these proceedings, and with the law developing rapidly, Banner & Witcoff will offer weekly summaries of the board's significant decisions and subsequent appeals at the U.S. Court of Appeals for the Federal Circuit.*



[www.bannerwitcoff.com](http://www.bannerwitcoff.com)

© Copyright 2014 Banner & Witcoff, Ltd. All Rights Reserved. The opinions expressed in this publication are for the purpose of fostering productive discussions of legal issues and do not constitute the rendering of legal counseling or other professional services. No attorney-client relationship is created, nor is there any offer to provide legal services, by the publication and distribution of this edition of PTAB Highlights.



**PTAB Draws Line on Admissibility of  
Declaration Evidence in IPR**

**Craig W. Kronenthal**

***Banner & Witcoff PTAB Highlights***

**September 3, 2014**

BANNER&WITCOFF

# PTAB HIGHLIGHTS

New developments in post-issuance proceedings

[bannerwitcoff.com](http://bannerwitcoff.com)

## PTAB Draws Line on Admissibility of Declaration Evidence in IPR

By Craig W. Kronenthal

September 3, 2014 — In a break from the PTAB’s trend of admitting evidence and allowing objections to admissibility to go to the weight of the evidence, the Board excluded testimonial evidence concerning the contents of documents that were not produced.

[IPR2013-00159 – Zodiac Pool Systems, Inc. v. Aqua Products, Inc. \(Paper 71, August 22, 2014\)](#)

The Patent Owner filed a motion to exclude evidence. Specifically, the Patent Owner moved to exclude several paragraphs of a declaration of one of Petitioner’s employees. In its final written decision finding all challenged claims unpatentable, the Board admitted into evidence most paragraphs of the declaration — explaining that the PTAB is “capable of according the appropriate weigh to testimony.” However, the Board drew the line when it came to a paragraph of the declaration that discussed the contents of documents that were referenced but not produced.

The Patent Owner argued that a particular paragraph of the declaration relied on information that was not produced or was in a foreign language (without English translations), and therefore, should be excluded from evidence as being prejudicial and contrary to Patent Office practices. The paragraph of the declaration referred to an engineering study, three sealed envelopes serving as proof of filing applications with France’s patent office, and nine French patent applications. The Petitioner, however, produced only one of these documents (one of the envelopes) and some supporting documents, which were in French. The Petitioner argued that at least a portion of the disputed paragraph should be admitted into evidence. Specifically, the Petitioner argued for admission of the following, offered for the purpose of disproving Patent Owner’s assertion that Petitioner copied the Patent Owner:

Zodiac had a third party engineering company conduct an engineering study, including a flow analysis on the inverted pump design and engineering drawings. This analysis took place in the spring and summer of 2007.

The Board found this part of the declaration inadmissible, stating that the “sentences relate to the content of cited documents, rather than solely to ‘facts that occurred.’” Accordingly, the Board granted, in part, the Patent Owner’s motion to exclude.

*The Leahy-Smith America Invents Act established new patent post-issuance proceedings, including the inter partes review, post grant review and transitional program for covered business method patents, that offer a less costly, streamlined alternative to district court litigation. With the U.S. Patent and Trademark Office’s Patent Trial and Appeal Board conducting a large and increasing number of these proceedings, and with the law developing rapidly, Banner & Witcoff will offer weekly summaries of the board’s significant decisions and subsequent appeals at the U.S. Court of Appeals for the Federal Circuit.*



[www.bannerwitcoff.com](http://www.bannerwitcoff.com)

© Copyright 2014 Banner & Witcoff, Ltd. All Rights Reserved. The opinions expressed in this publication are for the purpose of fostering productive discussions of legal issues and do not constitute the rendering of legal counseling or other professional services. No attorney-client relationship is created, nor is there any offer to provide legal services, by the publication and distribution of this edition of PTAB Highlights.

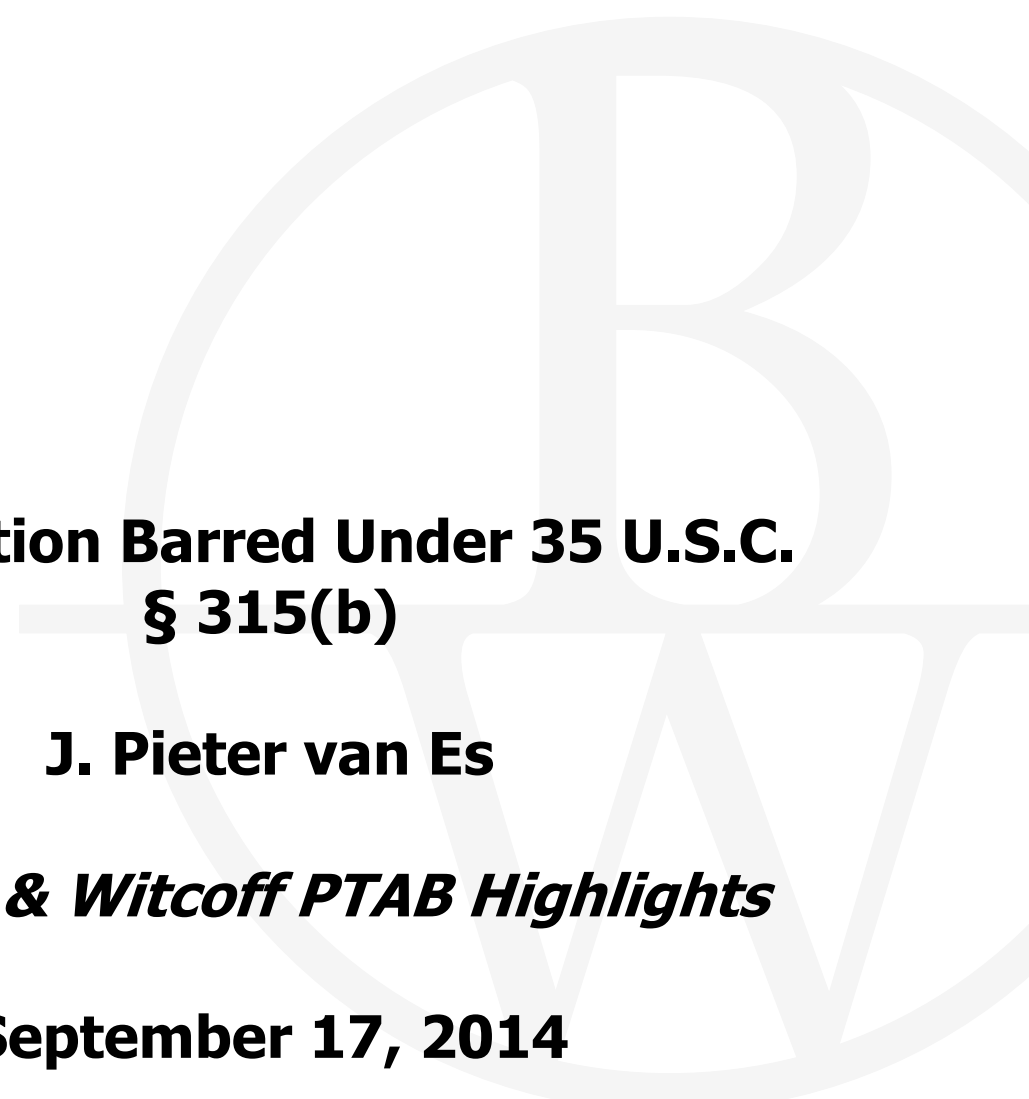

**IPR Petition Barred Under 35 U.S.C.  
§ 315(b)**

**J. Pieter van Es**

***Banner & Witcoff PTAB Highlights***

**September 17, 2014**

BANNER&WITCOFF

# PTAB HIGHLIGHTS

New developments in post-issuance proceedings

[bannerwitcoff.com](http://bannerwitcoff.com)

## IPR Petition Barred Under 35 U.S.C. § 315(b)

By J. Pieter van Es

September 17, 2014 – The PTAB denied a petition for *inter partes* review as barred under 35 U.S.C. § 315(b) because the PTAB determined that the petitioner was served with a complaint alleging infringement of the patent more than a year before it filed its petition.

[IPR2014-00779 – Histologics, LLC v. CDX Diagnostics, Inc. et al. \(Paper 6, Sept 12\)](#)

The petitioner requested institution of an *inter partes* review of U.S. Patent No. 6,258,044. According to the PTAB, the petitioner did not dispute that it was served with a complaint alleging infringement of the '044 patent soon after a complaint was filed on April 19, 2012. In the district court case, the petitioner moved to dismiss the complaint for lack of standing. Although the district court granted the motion to dismiss and ordered the action dismissed without prejudice, the action was stayed pending a bankruptcy proceeding, according to the PTAB. After bankruptcy, stay, transfer and consolidation issues were addressed, the case was pending in the Central District of California.

The petitioner argued its IPR petition was timely because it was not filed more than a year after being served with a “non-jurisdictionally deficient” complaint. Because suit was dismissed without prejudice, service of that complaint was nullified and did not trigger the time bar, according to the petitioner. The PTAB disagreed, finding that in view of the pending suit, the parties are not left in the same legal position as if the original action had never been filed, distinguishing *Macauto USA v. Bos GmbH*, Case IPR2012-00004 (PTAB 2013). The PTAB also distinguished *InVue Sec. Prods. Inc. v. Merch. Techs., Inc.*, Case IPR2013-00122 (PTAB 2013), because that case dealt with the dismissal of a declaratory judgment action for invalidity under 35 U.S.C. § 315(a), not the effect of dismissal of an infringement action under § 315(b).

*The Leahy-Smith America Invents Act established new patent post-issuance proceedings, including the inter partes review, post grant review and transitional program for covered business method patents, that offer a less costly,*

*streamlined alternative to district court litigation. With the U.S. Patent and Trademark Office's Patent Trial and Appeal Board conducting a large and increasing number of these proceedings, and with the law developing rapidly, Banner & Witcoff will offer weekly summaries of the board's significant decisions and subsequent appeals at the U.S. Court of Appeals for the Federal Circuit.*



[www.bannerwitcoff.com](http://www.bannerwitcoff.com)

© Copyright 2014 Banner & Witcoff, Ltd. All Rights Reserved. The opinions expressed in this publication are for the purpose of fostering productive discussions of legal issues and do not constitute the rendering of legal counseling or other professional services. No attorney-client relationship is created, nor is there any offer to provide legal services, by the publication and distribution of this edition of PTAB Highlights.



**PTAB Rejects “Unusual” Inventor  
Testimony That His Own Invention  
Was Not Reduced to Practice and  
Finds His Claims Not Unpatentable**

**J. Pieter van Es**

***Banner & Witcoff PTAB Highlights***

**September 17, 2014**



BANNER&WITCOFF

# PTAB HIGHLIGHTS

New developments in post-issuance proceedings

[bannerwitcoff.com](http://bannerwitcoff.com)

## PTAB Rejects “Unusual” Inventor Testimony That His Own Invention Was Not Reduced To Practice and Finds His Claims Not Unpatentable

By J. Pieter van Es

September 17, 2014 – In a final written decision, the PTAB found the petitioner failed to prove challenged claims unpatentable and rejected “unusual” inventor testimony about reduction to practice that was opposite the typical situation where inventor testimony is offered to establish an early invention date.

[IPR2013-00131 – Dynamic Drinkware LLC v. National Graphics, Inc. \(Paper 42, Sept. 12\)](#)

The patent owner did not attempt to distinguish the allegedly anticipatory art, but instead argued that it did not qualify as prior art. The PTAB agreed, finding that the petitioner failed to prove that the alleged prior art reference, a patent, was entitled to an earlier provisional application filing date, and that the patent owner established reduction to practice prior to the alleged prior art’s actual filing date.

According to the PTAB, the petition was deficient in establishing the earlier priority date of the alleged prior art because it only provided a chart comparing the priority provisional application to the challenged claims, but it did not also compare the asserted prior art patent to its priority provisional application. The Board appeared to require the petitioner to explicitly compare the challenged claims to subject matter common to both the asserted patent and its priority provisional application “to demonstrate that those portions were carried over from the provisional.” In not doing so, the PTAB found the petitioner failed to carry its burden to prove the effective date of the alleged prior art.

The PTAB also found that the patent owner swore behind the prior art patent’s actual filing date based on an earlier reduction to practice. Interestingly, the petitioner submitted a declaration of

the inventor in support of its position that the invention was not reduced to practice, which the PTAB noted is “unusual” as “normally” inventor testimony is proffered for the opposite position — to establish the earliest invention date. The inventor testified that he now worked for a company “related to” the petitioner. Discounting the inventor’s testimony because his “current interests are aligned against his patent,” the PTAB credited a notebook entry from the inventor and other testimony in concluding that the invention was reduced to practice prior to the filing date of the non-provisional application. The PTAB also conducted at the hearing a “visual inspection” of a sample that it concluded was reduced to practice.

*The Leahy-Smith America Invents Act established new patent post-issuance proceedings, including the inter partes review, post grant review and transitional program for covered business method patents, that offer a less costly, streamlined alternative to district court litigation. With the U.S. Patent and Trademark Office’s Patent Trial and Appeal Board conducting a large and increasing number of these proceedings, and with the law developing rapidly, Banner & Witcoff will offer weekly summaries of the board’s significant decisions and subsequent appeals at the U.S. Court of Appeals for the Federal Circuit.*



[www.bannerwitcoff.com](http://www.bannerwitcoff.com)

© Copyright 2014 Banner & Witcoff, Ltd. All Rights Reserved. The opinions expressed in this publication are for the purpose of fostering productive discussions of legal issues and do not constitute the rendering of legal counseling or other professional services. No attorney-client relationship is created, nor is there any offer to provide legal services, by the publication and distribution of this edition of PTAB Highlights.



**PTAB Continues to Deny IPR  
Petitions, Based on Arguments  
Incorporated by Reference**

**Michael S. CuvIELLO**

***Banner & Witcoff PTAB Highlights***

**September 22, 2014**

BANNER&WITCOFF

# PTAB HIGHLIGHTS

New developments in post-issuance proceedings

[bannerwitcoff.com](http://bannerwitcoff.com)

## PTAB Continues to Deny IPR Petitions, Based on Arguments Incorporated By Reference

By [Michael S. CuvIELLO](#)

September 22, 2014 – For the second time in a month (see our previous PTAB Highlight regarding IPR2014-00491 [here](#)), the PTAB has refused to consider arguments incorporated by reference into an IPR petition.

### [IPR 2014-00454 – Cisco Systems, Inc. v. C-Cation Technologies, LLC \(Paper 12\)](#)

In this decision denying institution of an *inter partes* review, the PTAB held that the practice of using footnotes in the IPR petition to cite large portions of an expert declaration without sufficient explanation of those portions amounted to impermissible incorporation by reference. The Board cited several examples of incorporation by reference, including: a seven-page invalidity argument of claim 1 in the petition incorporating 17 pages of the expert declaration, the petition claim charts incorporating other claim charts in the expert declaration, and conclusory statements in the petition being supported only by footnote references to the expert declaration.

The PTAB panel of judges in this decision applied nearly identical reasoning as applied by a different panel of judges in the previous [IPR2014-00491](#). The Board in this case explained: “In the Petition before us, incorporation by reference of numerous arguments from Dr. Roy’s 250-page Declaration into the Petition serves to circumvent the page limits imposed on petitions for inter partes review, while imposing on our time by asking us to sift through over 250 pages of Dr. Roy’s Declaration (including numerous pages of claim charts) to locate the specific arguments corresponding to the numerous paragraphs cited to support Petitioner’s assertions.”

Without the incorporated expert declaration, the Board refused to institute the *inter partes* review, finding that the petition did not: “(1) specify sufficiently where each element of the

claims is found in the applied references, and (2) include a detailed explanation of the significance of the quotations and citations from the applied references. See 37 C.F.R. §§ 42.104(b)(4), 42.22(a)(2).”

*The Leahy-Smith America Invents Act established new patent post-issuance proceedings, including the inter partes review, post grant review and transitional program for covered business method patents, that offer a less costly, streamlined alternative to district court litigation. With the U.S. Patent and Trademark Office’s Patent Trial and Appeal Board conducting a large and increasing number of these proceedings, and with the law developing rapidly, Banner & Witcoff will offer weekly summaries of the board’s significant decisions and subsequent appeals at the U.S. Court of Appeals for the Federal Circuit.*



[www.bannerwitcoff.com](http://www.bannerwitcoff.com)

© Copyright 2014 Banner & Witcoff, Ltd. All Rights Reserved. The opinions expressed in this publication are for the purpose of fostering productive discussions of legal issues and do not constitute the rendering of legal counseling or other professional services. No attorney-client relationship is created, nor is there any offer to provide legal services, by the publication and distribution of this edition of PTAB Highlights.



**PTAB Permits Entry of Declaration  
Testimony in an IPR Without  
Opposing Party's Opportunity  
To Cross-Exam**

**Michael S. CuvIELLO**

***Banner & Witcoff PTAB Highlights***

**September 22, 2014**

BANNER&WITCOFF

# PTAB HIGHLIGHTS

New developments in post-issuance proceedings

[bannerwitcoff.com](http://bannerwitcoff.com)

## PTAB Permits Entry of Declaration Testimony in an IPR Without Opposing Party's Opportunity to Cross-Exam

By [Michael S. CuvIELLO](#)

September 22, 2014 – In a Conduct of the Proceeding Order and Decision Denying Patent Owner's Motion for Additional Discovery, the PTAB addresses the situation of proffered declaration testimony that was not prepared for the purposes of the *inter partes* review, but instead for an unrelated proceeding.

[IPR2013-00576 – Mexichem Amanco Holdings S.A. de C.V. v. Honeywell International, Inc. \(Papers 31 and 36\)](#)

With its reply to the patent owner's preliminary response, the petitioner submitted an expert declaration from a re-exam proceeding of a patent related to the patent in the IPR through a number of continuation-in-part applications. The patent owner filed a motion to cross-examine the declarant by deposition, which the Board denied.

According to the PTAB, the cross-examination of the declarant is treated as "additional discovery" governed under rule 37 C.F.R. § 42.51(b)(2) rather than routine discovery governed under 37 C.F.R. § 42.51(b)(1)(ii). As additional discovery, the PTAB noted that the patent owner must meet the higher standard of showing that the cross-examination is "necessary in the interest of justice," and that the PTAB would apply a set of factors first outlined in *Garmin Int'l Inc. et al. v. Cuzzo Speed Techs. LLC*, Case IPR2012-00001, Paper 26, slip op. at 6-7 (PTAB March 5, 2013).

While the Board found that some *Garmin* factors weighed in favor of the patent owner, the PTAB denied the motion based substantially on *Garmin*'s fifth factor that the request would be overly burdensome, due to the declarant residing in Japan. Though the Board would not compel

the petitioner to produce the declarant, it stated that the declaration would be given “little to no weight,” unless the petitioner provided the patent owner a fair opportunity to challenge the declarant’s testimony.

Left unaddressed by the Board is how its order comports with the applicability of the Federal Rules of Evidence under 37 C.F.R. §42.62, including Rule 801 against the admissibility of hearsay and Rule 807 providing the residual exception to the hearsay rule.

**\*\*Disclosure:** Banner & Witcoff attorneys Joseph Berghammer and Joseph Skerpon are counsel for the patent owner in this *inter partes* review.

*The Leahy-Smith America Invents Act established new patent post-issuance proceedings, including the inter partes review, post grant review and transitional program for covered business method patents, that offer a less costly, streamlined alternative to district court litigation. With the U.S. Patent and Trademark Office’s Patent Trial and Appeal Board conducting a large and increasing number of these proceedings, and with the law developing rapidly, Banner & Witcoff will offer weekly summaries of the board’s significant decisions and subsequent appeals at the U.S. Court of Appeals for the Federal Circuit.*



[www.bannerwitcoff.com](http://www.bannerwitcoff.com)

© Copyright 2014 Banner & Witcoff, Ltd. All Rights Reserved. The opinions expressed in this publication are for the purpose of fostering productive discussions of legal issues and do not constitute the rendering of legal counseling or other professional services. No attorney-client relationship is created, nor is there any offer to provide legal services, by the publication and distribution of this edition of PTAB Highlights.





**PTAB Denies Institution of *Inter Partes*  
Review of Design Patent, Noting 35 U.S.C.  
171 is Not Proper Basis for IPR**

**Michael S. CuvIELLO**

***Banner & Witcoff PTAB Highlights***

**September 22, 2014**

BANNER&WITCOFF

# PTAB HIGHLIGHTS

New developments in post-issuance proceedings

[bannerwitcoff.com](http://bannerwitcoff.com)

## PTAB Denies Institution of *Inter Partes* Review of Design Patent, Noting 35 U.S.C. 171 is Not a Proper Basis for IPR

By [Michael S. CuvIELLO](#)

September 22, 2014 – In its decision denying institution of two IPRs, the PTAB outlines how allegedly functional elements of a design patent claim are addressed in an IPR obviousness analysis.

[IPR2014-00542](#) and [IPR2014-00555](#) – *Dorman Products, Inc. v. PACCAR, Inc.* (Papers [10](#) and [10](#))

At issue were claims in design patents D526,429S and D525,731S, each directed to the ornamental design of a truck headlamp. In both cases, the petitioner argued that certain features such as facets and a curved bezel of embodiments of the claims result from functional or mechanical considerations and therefore do not form part of the claims. In response, the patent owner argued, and the PTAB agreed, that whether or not such elements are functional, they must be considered and construed as part of the visual impression created by the patented design as a whole.

The PTAB noted that the petitioner conflated invalidity based on functionality under 35 U.S.C. § 171 with invalidity based on obviousness under 35 U.S.C. 103. Under section 171, an ornamental design of an article of manufacture may not be patented if the design is “primarily functional” rather than “primarily ornamental.” According to the petitioner’s line of reasoning, any illustrated feature considered to be “primarily functional” would be excluded from the scope of the claim (under section 171), and thus, the petitioner would not be required to show that allegedly functional feature anticipated or obvious.

The PTAB disagreed with this reasoning, stating that IPRs are limited to invalidity just under sections 102 and 103 (and based only on patents or printed publications). As such, determining whether certain claimed features should be disregarded as functional under section 171 (prior to performing the obviousness analysis under section 103) is beyond the scope of the proceedings. Accordingly, the Board concluded that the “allegedly functional elements identified by petitioner . . . must be considered in an obviousness analysis of the visual impression created by the patented design as a whole.” The Board further held that when including these allegedly functional elements in its analysis, the petitioner failed to show a reasonable likelihood of prevailing in either case.

*The Leahy-Smith America Invents Act established new patent post-issuance proceedings, including the inter partes review, post grant review and transitional program for covered business method patents, that offer a less costly, streamlined alternative to district court litigation. With the U.S. Patent and Trademark Office’s Patent Trial and Appeal Board conducting a large and increasing number of these proceedings, and with the law developing rapidly, Banner & Witcoff will offer weekly summaries of the board’s significant decisions and subsequent appeals at the U.S. Court of Appeals for the Federal Circuit.*



[www.bannerwitcoff.com](http://www.bannerwitcoff.com)

© Copyright 2014 Banner & Witcoff, Ltd. All Rights Reserved. The opinions expressed in this publication are for the purpose of fostering productive discussions of legal issues and do not constitute the rendering of legal counseling or other professional services. No attorney-client relationship is created, nor is there any offer to provide legal services, by the publication and distribution of this edition of PTAB Highlights.



**PTAB Provides Guidance for Meeting  
Burden to Show Written Description  
for Substitute Claim**

**John P. Iwanicki**

***Banner & Witcoff PTAB Highlights***

**September 24, 2014**

BANNER&WITCOFF

# PTAB HIGHLIGHTS

New developments in post-issuance proceedings

[bannerwitcoff.com](http://bannerwitcoff.com)

## PTAB Provides Guidance for Meeting Burden to Show Written Description for Substitute Claim

By [John P. Iwanicki](#)

September 24, 2014 – In a Final Written Decision finding the patentee’s claim 1 unpatentable, the PTAB denied a motion to add a substitute claim that added hundreds of words to challenged claim 1. The PTAB held that the patentee failed to explain the relevance of supporting citations to the patent, or how the substitute claim was an “integrated whole” within the context of the patent.

### [IPR2013-00322 – Respironics, Inc. v. ZOLL Medical Corporation \(Paper 46\)](#)

The patentee, Zoll, filed a motion to amend seeking to add a substitute claim for challenged claim 1. The substitute claim added hundreds of words, more than tripling its length. The motion provided a listing of string citations to the patent by column and line number. These were alleged to provide written description support for the amended language. The motion lacked an explanation of the relevance of the citations and was unsupported by an expert declaration.

The PTAB explained that a substitute claim will only be added to an *inter partes* review if the patentee meets a burden to show adequate written description in the original application and any “benefit applications” (applications to which benefit is claimed). In denying the motion to amend, the PTAB held that “Zoll’s string citations amount to little more than an invitation to us (and to Respironics, and to the public) to peruse the cited evidence and piece together a coherent argument for them. This we will not do; it is the province of advocacy.” The PTAB noted the contrast between the extensive amendments and the lack of any explanation of the relevance of the string citations. The PTAB stated “[s]o extensive a modification of the claim requires a more detailed showing of how each limitation of the proposed claim not only is disclosed in the original and benefit applications, but also is disclosed in combination with all of the other

claim limitations. See *Novozymes A/S v. DuPont Nutrition Biosciences APS*, 723 F.3d 1336, 1349 (Fed. Cir. 2013) (claim is considered as an “integrated whole” when assessing written description).

Zoll attempted to cure the deficiencies of its motion with a reply that included both a claim chart identifying citation support for the proposed claim limitations and an expert declaration. But, the PTAB criticized the reply as “too little, too late” on substantive and procedural grounds.

The PTAB determined that neither the expert declaration nor the claim chart explained the relevance of the citations to the proposed claim limitations or how the citations, which were “dispersed throughout the specification and figures, demonstrate possession of the claimed subject matter as an ‘integrated whole.’” The PTAB also noted that the proper role of a reply brief is to “refute arguments and evidence advanced by the opposing party.” In contrast, the PTAB viewed Zoll’s reply brief as an attempt to improve its original motion by presenting additional evidence in support of written description. The PTAB criticized Zoll for not explaining why the expert declaration could not have been provided with the motion or why the late evidence should even be considered. The PTAB also accused Zoll of attempting to circumvent the reply brief page limit by not discussing within the reply itself the evidence in the expert declaration and claim chart.

In denying the motion to amend, the PTAB did not conclude that the proposed substitute claim lacked adequate written description. Instead, the PTAB decided that Zoll did not meet its burden of proving adequate written description for the proposed substitute claim based on the record before it. The PTAB did not reach the issue of whether the proposed substitute claim was patentable over the prior art.

*The Leahy-Smith America Invents Act established new patent post-issuance proceedings, including the inter partes review, post grant review and transitional program for covered business method patents, that offer a less costly, streamlined alternative to district court litigation. With the U.S. Patent and Trademark Office’s Patent Trial and Appeal Board conducting a large and increasing number of these proceedings, and with the law developing rapidly, Banner & Witcoff will offer weekly summaries of the board’s significant decisions and subsequent appeals at the U.S. Court of Appeals for the Federal Circuit.*



[www.bannerwitcoff.com](http://www.bannerwitcoff.com)

© Copyright 2014 Banner & Witcoff, Ltd. All Rights Reserved. The opinions expressed in this publication are for the purpose of fostering productive discussions of legal issues and do not constitute the rendering of legal counseling or other professional services. No attorney-client relationship is created, nor is there any offer to provide legal services, by the publication and distribution of this edition of PTAB Highlights.

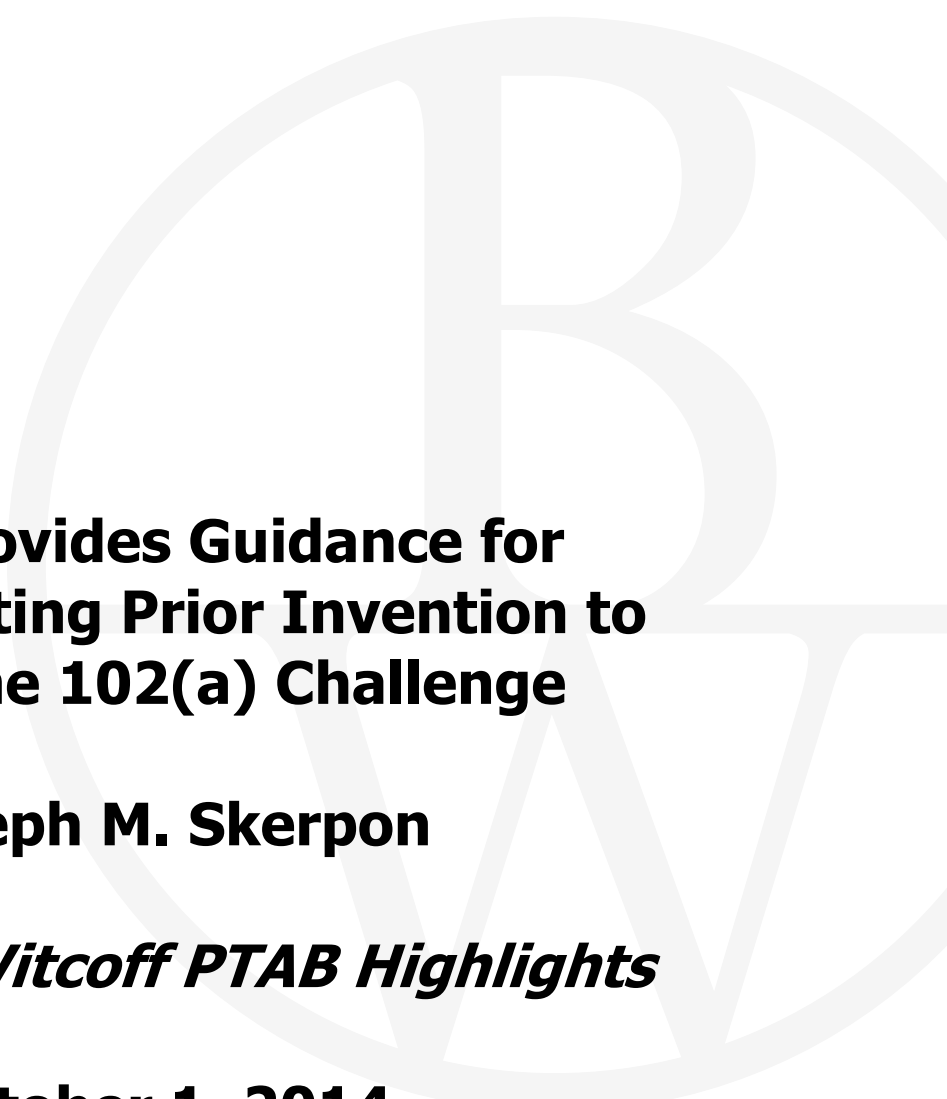

**PTAB Provides Guidance for  
Demonstrating Prior Invention to  
Overcome 102(a) Challenge**

**Joseph M. Skerpon**

***Banner & Witcoff PTAB Highlights***

**October 1, 2014**

BANNER&WITCOFF

# PTAB HIGHLIGHTS

New developments in post-issuance proceedings

[bannerwitcoff.com](http://bannerwitcoff.com)

## PTAB Provides Guidance for Demonstrating Prior Invention to Overcome 102(a) Challenge

By Joseph M. Skerpon

October 1, 2014 — In a Final Written Decision finding the patent owner’s claims unpatentable, the PTAB provided guidance on establishing prior invention to overcome a challenge under 35 U.S.C. 102(a). The PTAB also commented concerning the grounds in an original petition seeking an *inter partes* review and attempting to “reserve rights” in a petition.

[IPR2013-00364 – Handi Quilter, Inc. and Tacony Corporation v. Bernina International AG \(Paper 39\)](#)

In *Handi Quilter*, patent owner unsuccessfully attempted to show prior invention in response to a 35 U.S.C. 102(a) challenge. In its Final Decision (Paper 39), the PTAB outlined the two ways of demonstrating prior invention over a published reference citable only under 35 U.S.C. 102(a): (1) proving a reduction to practice before the publication of the reference or (2) demonstrating a prior conception coupled with reasonable diligence to a reduction to practice (actual or constructive) after the publication of the reference. Here, the patent owner attempted to prove prior conception with diligence, but failed to demonstrate a complete conception.

The patent owner was handcuffed to a large extent by the death of its sole inventor less than a year before the filing of the petition. Fortunately for the patent owner, the inventor and his attorney were previously aware of the existence of the key reference (Watabe) and had done an investigation and collected relevant documents before the inventor’s death. Unfortunately, neither had the foresight to document the investigation to establish a sufficient record, according to the PTAB. The record lacked the reliability and credibility essential to a satisfactory showing of prior invention.



The PTAB's decision is instructive not only for its critique of the nature of the evidentiary record, but also for highlighting the need to keep all of the elements of the claimed invention in focus when attempting to prove prior invention. Even if the evidentiary record did not have the reliability and credibility shortcomings caused by the untimely death of the inventor, the patent owner's attempt to show prior conception still would not have been successful because the patent owner overlooked one key element of the claim.

The invention pertained to a method of stitching together two or more fabric layers of a fabric stack as done in quilting. According to the invention, a motion detector monitored the movement of the fabric stack. Signals generated by the motion detector were input to a control circuit, which then synchronized automatically the delivery of stitch strokes with the movement of the fabric stack. The inventor had drawn a flow schematic (basic algorithm) of the method and this served as the key item of evidence. Arguably, the drawing illustrated the use of a motion detector to monitor the movement of the fabric stack and suggested the use of that information to perform "a comparison . . . to a 'set stitch length' to decide whether to stitch." However, the document failed to illustrate specifically how one would use that information to control the sewing machines' stitch head responsive to the movement of the fabric stack. Furthermore, "Patent Owner [did] not present[ ] evidence that mere ordinary skill in the art would have been required to reduce to practice the invention, as ultimately claimed, which requires controlling the stitch head or needle arm so that it actuates in response to detected movement."

The PTAB explained that to show conception, one must demonstrate that the inventor had formed a mental outline of the complete invention so that only ordinary skill would be necessary to reduce the invention to practice, citing *Burroughs Welcome Co. v. Barr Labs., Inc.*, 40 F.3d 1223, 1228 (Fed. Cir. 1994). Here, the patent owner failed to account for the control element of the claim in its proofs. Since the algorithm assumed the control feature without a specific illustration of any suitable circuit, the patent owner's failure to demonstrate that a person of ordinary skill in the art would be able to supply a suitable circuit was fatal to its case.

In rendering its decision, the PTAB also provided comments concerning the grounds detailed in an original petition seeking an IPR. The cited Watabe reference was potentially relevant under both 35 U.S.C. 102(a) and 102(b) and the petitioner sought to preserve in its petition its options by "reserving the right" to assert the Watabe reference also under 102(b). The PTAB noted that the petition must both identify the specific grounds for the patentability challenge and must demonstrate how the challenged claims are unpatentable under every challenged ground. It is not possible to defer that showing, so the PTAB rejected this attempted reservation of rights. As a corollary, the PTAB also reaffirmed an earlier holding that it does not presume that a patent is entitled under 35 U.S.C. 120 to the benefit of an earlier filing date of a priority application that does not share the same disclosure as the patent.

*The Leahy-Smith America Invents Act established new patent post-issuance proceedings, including the inter partes review, post grant review and transitional program for covered business method patents, that offer a less costly, streamlined alternative to district court litigation. With the U.S. Patent and Trademark Office's Patent Trial and Appeal Board conducting a large and increasing number of these proceedings, and with the law developing rapidly, Banner & Witcoff will offer weekly summaries of the board's significant decisions and subsequent appeals at the U.S. Court of Appeals for the Federal Circuit.*



[www.bannerwitcoff.com](http://www.bannerwitcoff.com)

© Copyright 2014 Banner & Witcoff, Ltd. All Rights Reserved. The opinions expressed in this publication are for the purpose of fostering productive discussions of legal issues and do not constitute the rendering of legal counseling or other professional services. No attorney-client relationship is created, nor is there any offer to provide legal services, by the publication and distribution of this edition of PTAB Highlights.



**To Stay or Not to Stay**

**Katie L. Becker**

***Banner & Witcoff PTAB Highlights***

**October 10, 2014**

BANNER&WITCOFF

# PTAB HIGHLIGHTS

New developments in post-issuance proceedings

[bannerwitcoff.com](http://bannerwitcoff.com)

## To Stay or Not to Stay...

By Katie L. Becker

October 10, 2014 — The Federal Circuit recently decided its second case<sup>1</sup> on the issue of staying a district court patent infringement litigation pending Covered Business Method (CBM) review. In *Benefit Funding Systems v. Advance America Cash*, Case No. 2014-1122 (Fed Cir. Sept. 25, 2014), the Federal Circuit affirmed the district court's order staying the litigation.

[Case No. 2014-1122 – Benefit Funding Systems v. Advance America Cash \(Fed Cir. Sept. 25, 2014\)](#)

The technology at issue relates to a “system and method for enabling beneficiaries of retirement benefits to convert future benefits into current resources to meet current financial and other needs and objectives.” Roughly 10 months after Benefit Funding Systems LLC and Retirement Capital Access Management Company LLC filed its complaint in the District of Delaware for patent infringement against Advance America Cash Advance Centers, Inc., Regions Financial Corporation, CNU Online Holdings, and U.S. Bancorp, U.S. Bancorp filed a petition with the PTAB for CBM review. All defendants then filed motions to stay the litigation pending review, which the court subsequently denied.

Following denial of the motions to stay by the district court, the PTAB instituted CBM review on the sole basis of subject matter eligibility under 35 U.S.C. § 101. The defendants renewed their motions to stay, which the district court granted. The patent owner then filed an interlocutory appeal. The patent owner's argument on appeal rests on the ground that the PTAB is not authorized to conduct CBM review based on § 101 grounds and thus the district court would not

---

<sup>1</sup> The first Federal Circuit case on this issue was *VirtualAgility, Inc. v. Salesforce.com, Inc. et al.*, Case No. 2014-1232 (Fed. Cir. July 10, 2014). The Court reversed the district court's order denying a stay pending the outcome of CBM review.

be bound by the results of the review<sup>2</sup>. The Federal Circuit disagreed that such an argument would be a proper basis for denying a stay.

In its decision authored by Chief Judge Prost, the Court concludes that the district court properly considered and analyzed the four factors set forth in AIA § 18(b)(1) to determine whether a stay is appropriate: (A) whether a stay, or the denial thereof, will simplify the issues in question and streamline the trial; (B) whether discovery is complete and whether a trial date has been set; (C) whether a stay, or the denial thereof, would unduly prejudice the nonmoving party or present a clear tactical advantage for the moving party; and (D) whether a stay, or the denial thereof, will reduce the burden of litigation on the parties and on the court. The Court went on to find that that “the argument that §101 cannot support CBM review is a collateral attack similar to ones that we have recently held impermissible” and further concluded that “[t]he stay determination is not the time or the place to review the PTAB’s decisions to institute a CBM proceeding.” *Citing* 2014 WL 3360606 at \*5. The Court similarly found that challenging the PTAB’s authority to conduct the CBM review in disputing an order staying litigation is also an impermissible collateral attack.

Lastly, the Court found that in the context of this case, the patent owner provided no basis for challenging the district court’s conclusion with respect to the second and third factors and found that “where the only real argument against a stay concerns the authority of the PTAB to conduct the CBM review, those circumstances are sufficient for the district court to conclude that the first and fourth factors favor staying the case.”

*The Leahy-Smith America Invents Act established new patent post-issuance proceedings, including the inter partes review, post grant review and transitional program for covered business method patents, that offer a less costly, streamlined alternative to district court litigation. With the U.S. Patent and Trademark Office’s Patent Trial and Appeal Board conducting a large and increasing number of these proceedings, and with the law developing rapidly, Banner & Witcoff will offer weekly summaries of the board’s significant decisions and subsequent appeals at the U.S. Court of Appeals for the Federal Circuit.*



[www.bannerwitcoff.com](http://www.bannerwitcoff.com)

© Copyright 2014 Banner & Witcoff, Ltd. All Rights Reserved. The opinions expressed in this publication are for the purpose of fostering productive discussions of legal issues and do not constitute the rendering of legal counseling or other professional services. No attorney-client relationship is created, nor is there any offer to provide legal services, by the publication and distribution of this edition of PTAB Highlights.

---

<sup>2</sup> The patent owner also raised this argument at the district court.



**Goodbye Patent Arbitration?**

**Charles W. Shifley**

***Corporate Counsel***

**October 13, 2014**

 [Click to Print](#) or Select '**Print**' in your browser menu to print this document.

Page printed from: [Corporate Counsel](#)

---

From the Experts

## Goodbye Patent Arbitration?

Charles W. Shifley, Corporate Counsel

October 13, 2014

Patent dispute resolution has been trending into arbitration, while arbitration has been looking like litigation. But now patent reviews through the U.S. Patent and Trademark Office (PTO) offer the fast, cheap proceedings that arbitration is supposed to provide—and they just may kill the old way of arbitrating those disputes.

According to the American Arbitration Association, in its rules for patent disputes, “a growing number of intellectual property disputes are arbitrated [by the AAA] each year.” Several milestone events encouraged this trend. President Ronald Reagan signed legislation that became 35 U.S.C. 294 in 1983, authorizing federal courts to enforce agreements to arbitrate, whether made in advance or at the time of any patent disputes. A National Patent Board, now merged with the AAA, was organized by corporate lawyers in 1998. The board offered a six-month schedule, one-day hearings with briefs, a pretrial conference, oral argument and a decision by patent lawyers. The Federal Arbitration Act, 9 U.S.C. Sections 1-14, enacted in 2000, made arbitration awards of all types, including patent, subject to only limited review by courts. In 2004 one author wrote that patent arbitration had become a highly utilized alternative to patent litigation.

In 2006 the AAA rules for patent disputes took effect. The AAA asserted that arbitration has the advantages of relative speed and economy, privacy, reduced likelihood of damage to ongoing business relationships, ease of enforcement in the international context and the ability of the parties to customize the process and select arbitrators who are experts familiar with the subject matter of the dispute.

Those rules, however, ran contrary to speed and economy. After selection of arbitrators, a hearing is held with a resulting scheduling order. The order is to require initial disclosures of asserted patent claims, initial exchanges of (a) preliminary infringement contentions of literal and equivalent infringement; (b) preliminary invalidity contentions of anticipation and obviousness; (c) charts of accusations; and (d) several groups of documents. These include conception, on sale and prior art documents, followed by a patent claim construction process and hearing, identification of experts and exchange of experts reports, discovery deadlines, a protocol for introducing sworn statements and deposition testimony, a prehearing conference, a hearing and, if desired, a reasoned award.

The procedures are much like those required by the local patent rules common in patent-heavy federal courts. They front-load cases with high expenses by requiring thoroughly prepared initial exchanges at the risk of being blocked from introducing evidence not in the disclosures, and by taking early positions with which experts may later disagree.

But here's the good news. The America Invents Act of 2011 has given the "Pea-Tab"—the Patent Trial and Appeal Board (PTAB) of the PTO—quasi-trial-like, and rocket-docket-like, jurisdiction over issued patents. The PTAB cannot decide issues of infringement, but it can judge that patents and their claims are unpatentable in judgments the PTO will respect by canceling both patents and claims. As a result, since late 2012, 1,100 petitions for PTAB reviews of patents have been filed. In the first half of 2014, filings increased 125 percent over the total filings in 2013.

PTAB proceedings like this come in three flavors: inter partes reviews (IPRs), postgrant reviews (PGRs) and covered business method reviews (CBMs). All three are intended to begin and end in about 12 months. They are implemented after a challenger files a petition, which is unlike a federal court complaint and detailed in specifics similar to a patent case summary judgment motion. The patent owner may or may not respond. The PTAB will next decide whether to institute the proceeding based on the petition, by determining, for an IPR, whether there is a reasonable likelihood of success, and for a PGR or CBM, whether success is more likely than not. A scheduling order will enter, and the "trial" will have begun.

If the patent owner chooses, he or she responds to the petition, and/or moves to amend the patent, typically within three months. Direct testimony is by affidavit. If the patent owner wants to take cross-examination depositions, this is the period for them. An equal petitioner's period for similar depositions follows. Wide-ranging discovery is blocked. More activities and due dates follow closely. Once these are complete, the quasi-trial concludes, typically, with an oral argument. Judgment soon follows, if the dispute has not been settled, and confirms claims or concludes they are not patentable.

Compared to arbitration, PTAB proceedings certainly have benefits for patent challengers. Perhaps foremost, the PTAB decisions to date have held many patent claims unpatentable. There is no baby-splitting or decision-dodging on patent validity with the PTAB. Plus, canceled claims cannot be infringed. While petition filing fees run into the low tens of thousands of dollars, in PTAB proceedings, no arbitrators are charging hourly fees comparable to those of well-paid lawyers for case management, discovery and other interim dispute resolutions—not to mention claim construction deliberation and hearings; live-witness days-long trials; case decision making and "rational decision" writing.

The parties' counsel are also not engaged in a wide-ranging set of disputes, motions and paper filings—all made possible, and in many instances required, by either the AAA patent rules or arbitrators who like them. Also, PTAB judges are typically well-trained, experienced patent lawyers who are also "precedent-attuned" and in their primes. Furthermore, patent owners cannot assert that invalidity must be proven by clear and convincing evidence, or that their patents must be presumed to be valid. And in the event of losses, design-arounds of patent claims may be made much easier by binding statements of patent owners about the limits of their inventions during the proceedings.

For patent owners, there are also benefits. PTAB judges follow PTO approaches to the patent law. For example, PTAB judges often give little respect to extravagant arguments



about what was known in the fields of the inventions when not proven by cold, hard evidence. Challengers who fail in PTAB proceedings also do not get second bites at patent validity; they are blocked, in most situations.

So, what will the future hold for the resolution of patent disputes? Arbitration agreements are made in both forward-looking, blanket forms by parties in long-term relationships, and in “one-off” forms by parties to flared-up disputes. Parties in both types may see arbitration agreements, however, as forcing them to stay away from the best forum for their disputes—the PTAB. That is because parties may not resort to PTAB proceedings when federal law forces them to resolve patent disputes exclusively in arbitration.

The upshot of the rise of PTAB proceedings may be, then, that in the near future the arbitration of patent disputes withers away and dies. Arbitration agreements that might have been made will go unmade, or will exempt patent disputes from arbitration. PTAB proceedings may take over the role of arbitration for those who want nonlitigation resolutions of their patent disputes.

*Charles W. Shifley is a principal in Banner & Witcoff Ltd.'s Chicago office. He has served as lead and cocounsel in numerous successful IP trials and appeals for Fortune 100 (and other) companies nationwide.*



**Don't Try to Barnstorm Proof of  
Printed Publication**

**H. Wayne Porter**

***Banner & Witcoff PTAB Highlights***

**October 16, 2014**

BANNER&WITCOFF

# PTAB HIGHLIGHTS

New developments in post-issuance proceedings

[bannerwitcoff.com](http://bannerwitcoff.com)

## Don't Try to Barnstorm Proof of Printed Publication

By [H. Wayne Porter](#)

October 16, 2014 — The PTAB recently denied institution of *inter partes* review based on a petitioner's failure to prove that a document was indeed a printed publication qualifying as prior art to the patent at issue.

[IPR2014-00671 – A.R.M., Inc. v. Cottingham Agencies Ltd. \(Paper 10\)](#)

The patent in question is titled “Amusement Ride.” In a decision entered October 3, 2014, the PTAB denied a petition to institute *inter partes* review. The decision is notable for two things. First, the decision includes an impressive drawing depicting an embodiment of a ride which, as summarized by the PTAB, involves “conveyance of riders through the air in a manner simulating flight at an elevation sufficiently high to produce a thrilling sensation”:

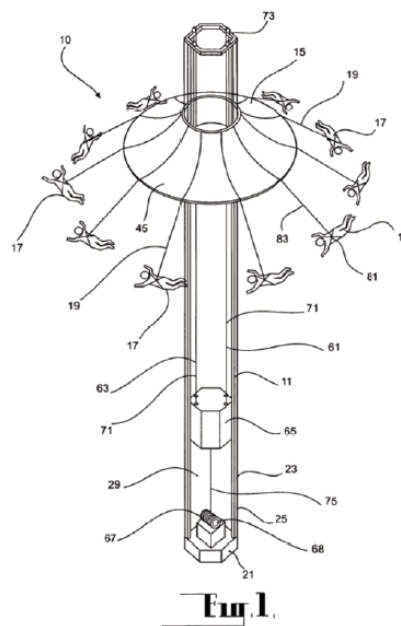

Second, the decision denied institution of trial because the petitioner failed to prove that a document qualified as prior art to the patent at issue. The petitioner challenged claims of the patent as obvious over various combinations of references that included a one-page, undated document depicting a ride known as the “Barnstormer.” The petitioner also submitted a declaration and argued that the declaration dated the Barnstormer document before the filing date of the patent at issue.

The PTAB noted that, in fact, the declaration did not identify any date for the Barnstormer document, and that no date appeared on the face of the document. The PTAB also noted that the petitioner provided virtually no argument or evidence in support of a conclusion that the Barnstormer document was a printed publication available as prior art to the patent at issue.

As indicated by the PTAB, the key inquiry was whether the Barnstormer document was made “sufficiently accessible to the public interested in the art” before the relevant date, and that “[a] given reference is ‘publicly accessible’ upon a satisfactory showing that such document has been disseminated or otherwise made available to the extent that persons interested and ordinarily skilled in the subject matter or art exercising reasonable diligence, can locate it.” Although the PTAB acknowledged that the petitioner provided evidence that the Barnstormer *ride* was operated and available to the public before the relevant date, the PTAB found that the petitioner offered no evidence of a date when the Barnstormer *document* was a publication, and no evidence that the Barnstormer document was disseminated or otherwise made available such that relevant persons could locate it.

This decision highlights the importance of a petitioner satisfying its burden to prove a non-patent document is, in fact, a printed publication under 35 U.S.C. § 102. The decision also highlights one of the limitations of the *inter partes* review procedure. In particular, an *inter partes* review can only be instituted on the basis of prior art consisting of patents or printed publications. Other types of prior art such as prior public use is not enough. As can be seen by comparing an image from the Barnstormer document (below left), and an image from the declaration submitted by the petitioner (below right),

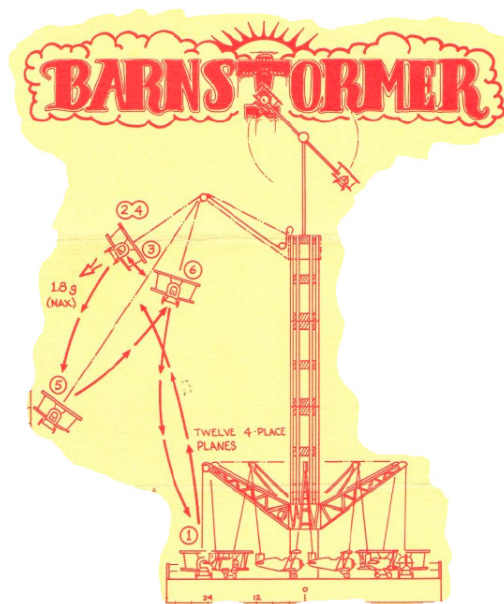

the public use prior art and the Barnstormer document appear to show the same thing, yet the Barnstormer document failed to constitute a printed publication, so the petition to institute an *inter partes* review trial was denied.

*The Leahy-Smith America Invents Act established new patent post-issuance proceedings, including the inter partes review, post grant review and transitional program for covered business method patents, that offer a less costly, streamlined alternative to district court litigation. With the U.S. Patent and Trademark Office's Patent Trial and Appeal Board conducting a large and increasing number of these proceedings, and with the law developing rapidly, Banner & Witcoff will offer weekly summaries of the board's significant decisions and subsequent appeals at the U.S. Court of Appeals for the Federal Circuit.*



[www.bannerwitcoff.com](http://www.bannerwitcoff.com)

© Copyright 2014 Banner & Witcoff, Ltd. All Rights Reserved. The opinions expressed in this publication are for the purpose of fostering productive discussions of legal issues and do not constitute the rendering of legal counseling or other professional services. No attorney-client relationship is created, nor is there any offer to provide legal services, by the publication and distribution of this edition of PTAB Highlights.



**PTAB Post Office Decision Shows  
CBM Proceedings Not Limited to  
Finance Companies**

**Charles W. Shifley**

***Banner & Witcoff PTAB Highlights***

**October 24, 2014**

BANNER&WITCOFF

# PTAB HIGHLIGHTS

New developments in post-issuance proceedings

[bannerwitcoff.com](http://bannerwitcoff.com)

## PTAB Post Office Decision Shows CBM Proceedings Not Limited to Finance Companies

By [Charles W. Shifley](#)

October 24, 2014 — In Covered Business Method (CBM) proceedings at the PTAB, a financial service is not necessarily just a service that acts on financial information—at least not in a proceeding between the U.S. Post Office and a competitor called Return Mail.

Everyone knows the Post Office is struggling. The Internet is making Post Office mail a pejorative: “snail mail.” No surprise, mail volume is going straight down. Mailing DVDs, Netflix was recently the biggest mail customer of the postal system, but the Internet is rapidly bringing an end to their mail service. The Post Office lost \$2 billion in just the three months of April through June, 2014. Everyone knows what it means to “go postal.” And does anyone lack for a Post Office joke?

But surprising though it is, this embattled butt of jokes still providing a 19th century service is also a target for assertions of patent infringement. Equally surprising, it has the resources and will to battle back aggressively and help create odd law. The only segment of mail business at the Post Office that isn’t dropping is junk mail, a/k/a bulk mail. When that segment is targeted by a patent owner, the Post Office may have extra incentive to act.

### [CBM2014-00116 – United States Postal Service v. Return Mail, Inc. \(Paper 11\)](#)

In CBM 2014-00116, the entanglements and creative arguments the Post Office can bring to a patent situation are on display. The Post Office filed the petition for the proceeding, and is putting weight into taking down a patent owned by Return Mail. The Post Office asserted the patent is invalid in nine ways. The CBM proceeding, moreover, is not the only or the first battle in a seeming war between the Post Office and Return Mail. Currently, Return Mail is suing the Post Office for compensation for infringement in the Federal Court of Claims. The accused

service in that lawsuit is “OneCode Address Correction,” a free Post Office service that is good for senders of junk and bulk mail. Return Mail’s patent was also the subject of extensive previous PTO proceedings. The patent reissued, with all original claims canceled, and was re-examined too, at the request of the Post Office. The PTAB resolved to institute the CBM proceeding, in spite of past challenges to and changes in the patent.

Return Mail is in Alabama. It claims that it once employed 20 people, but now has 10, due to Post Office competition, and once attempted to work with and license the Post Office. [http://blog.al.com/businessnews/2011/03/birmingham\\_return\\_mail\\_inc\\_su.html](http://blog.al.com/businessnews/2011/03/birmingham_return_mail_inc_su.html)

The Return Mail patent is about handling mail that cannot be delivered. Return Mail started its business to take returned mail, search for new addresses to deliver it, and update databases of mail addresses for those who would buy this service. The patent claims a method in which envelopes have a code indicating whether the mail, if undelivered, will receive the effort to find a new address. The method of the patent is reading the code, finding a new address, and sending the new address to the sender, for any next mail to be sent. OneCode Address Correction works in a similar manner.

The central issue in CBM2014-00116, as might be guessed, is the application of the recent Supreme Court decision *Alice Corp. v. CLS Bank Int’l.* — it is the question of whether the Return Mail patent covers an invention that was even eligible to get patented.

Most worthy of attention is how the Post Office persuaded the PTAB to consider a patent on handling returned mail to be a fit for a CBM proceeding. As the PTAB opinion expressly says, a “‘covered business method patent’ is a patent that ‘claims a method or apparatus for performing data processing or other operations used in the practice, administration, or management of a financial product or service’” – and that type of patent, *only*.

How is the handling of return mail a “financial product or service?” Says the Post Office, the patent includes subject matter that is financial in nature because it “provides a method for easing the administrative burdens of finance companies, mortgage companies, and credit card companies by making relaying updated mail address data more cost effective.” Says the PTAB, “we agree with USPS that” handling return mail for such companies “satisfies the ‘financial product or service’ component of the definition” of CBM patents.

It may be that the Post Office has to act strongly to protect its steady junk and bulk mail business, and thus had to create its argument ingenuously. It may matter to the PTAB agreement with the argument that Return Mail did “not dispute” that the patent subject matter “is financial in nature.” But a lesson of the institution of this CBM proceeding could surely be that the PTAB may not be limiting the definition of CBM patents to those patents that involve the actual manipulation of financial information.

By this example, a patent directed to activity as pedestrian and mundane as handling the mail is the “administration” of a “financial product or service” if the mundane activity is one in which financial companies engage — among the companies of possibly many other industries. As a result, owners of patents on subjects distant from acting on financial information should



consider whether CBM proceedings on their patents are in their future. Patents on subjects such as scheduling employee work days, taking and filling orders for meals in conference rooms, and efficiently taking out the trash, as examples, all cover activities of “finance companies, mortgage companies, and credit card companies.” Under the PTAB’s reasoning, patents with claims directed to such activities could be open to attack in a CBM.

*The Leahy-Smith America Invents Act established new patent post-issuance proceedings, including the inter partes review, post grant review and transitional program for covered business method patents, that offer a less costly, streamlined alternative to district court litigation. With the U.S. Patent and Trademark Office’s Patent Trial and Appeal Board conducting a large and increasing number of these proceedings, and with the law developing rapidly, Banner & Witcoff will offer weekly summaries of the board’s significant decisions and subsequent appeals at the U.S. Court of Appeals for the Federal Circuit.*



[www.bannerwitcoff.com](http://www.bannerwitcoff.com)

© Copyright 2014 Banner & Witcoff, Ltd. All Rights Reserved. The opinions expressed in this publication are for the purpose of fostering productive discussions of legal issues and do not constitute the rendering of legal counseling or other professional services. No attorney-client relationship is created, nor is there any offer to provide legal services, by the publication and distribution of this edition of PTAB Highlights.



**PTAB Cracking Down on Serial IPR  
Petitions**

**Christopher L. McKee**

***Banner & Witcoff PTAB Highlights***

**November 4, 2014**

BANNER&WITCOFF

# PTAB HIGHLIGHTS

New developments in post-issuance proceedings

[bannerwitcoff.com](http://bannerwitcoff.com)

## PTAB Cracking Down on Serial IPR Petitions

By [Christopher L. McKee](#)

November 4, 2014 — The estoppels of 35 U.S.C. §315(e)(1) don't kick in to bar a petitioner from filing a second *inter partes* review petition against the same patent until a final written decision is rendered in the first. Hence, a practice has arisen where, in some instances, petitioners have filed a first petition and then a subsequent petition challenging the same claims on new or supplemented grounds. This typically occurs in the case of a first petition being denied, in part or in full.

35 U.S.C. §325(d) provides:

In determining whether to institute or order a proceeding under this chapter [post-grant review (PGR)], chapter 30 [*ex parte* reexamination] or chapter 31 [*inter partes* review (IPR)], the Director may take into account whether, and reject the petition or request because, the same or substantially the same prior art or arguments previously were presented to the Office.

Thus, it has been reasonably clear that an IPR petition had better raise substantially different prior art and arguments than any earlier petition against the same patent in order to stand a chance of being granted. Recent decisions, however, reflect the imposition of a further requirement by the Board. This additional requirement resembles the “reasonably could have raised” aspect of estoppel under 35 U.S.C. §315(e).

[IPR2014-00628 – Conopco, Inc. dba Unilever v. The Proctor & Gamble Company \(Paper 21\)](#)

In this recent decision, entered on October 20, 2014, the Board emphasized the discretionary nature of its decision to institute an IPR or not. Section 325(d) permits the Board, in the exercise

of its discretion, to take into account whether “substantially the same prior art or arguments were previously presented to the Office.” Worth noting here is that merely presenting different prior art may not be sufficient. If the new prior art is relied on in a similar manner as other prior art was before, it may be considered that the “argument” is substantially the same, and institution of an IPR may be denied upon this basis. Although the petition in *Unilever* presented new prior art, the Board determined that “the two petitions are based on ‘substantially the same’ argument; namely, that the prior art identifies, with anticipatory specificity, a cationic guar derivative having a molecular weight and charge density that meets the specified ranges,” an element of the claimed shampoo composition.<sup>1</sup>

Perhaps even more notable, however, is the Board’s reluctance to grant a subsequent petition where the petitioner has not established that the newly relied upon prior art was not “known and available” to the petitioner when it filed its first IPR Petition. The Board in *Unilever* stated:

On this record, the interests of fairness, economy, and efficiency support declining review -- a result that discourages the filing of a first petition that holds back prior art for use in successive attacks, should the first petition be denied.

Regarding unfairness to the patent owner, the Board further noted: “P&G raises a legitimate concern that Unilever will continue to mount serial attacks against the ‘155 patent claims, until a ground is advanced that results in the institution of review.” Regarding economy and efficiency, the Board noted: “On this record, we are persuaded that our resources are better spent addressing matters other than Unilever’s second attempt to raise a plurality of duplicative grounds against the same patent claims.”

Similarly, in an earlier decision involving the same parties and the same panel, but a different patent, a factor leading to the Board’s denial of a second petition was that the petition “present[ed] no argument or evidence that ... seven newly cited references were not known or available ... at the time of filing of the [earlier] Petition.” [\*Unilever, Inc. dba Unilever v. The Proctor & Gamble Company\*, IPR2014-00506](#) (paper 17, entered July 7, 2014). Significantly, the PTAB has designated this earlier decision “informational.”

The take away? IPR (and PGR/Covered Business Method (CBM) review) petitioners should not assume that a second opportunity will exist for pursuing a second review to assert additional prior art “known and available” at the time of the first petition filing. The safe assumption would be that, in general, prior art known and available at the time of a first petition, but not included in the first petition, is unlikely to form a successful basis of a second petition. In other words, petitioners who hold back prior art for use in a subsequent petition do so at significant risk. Where a subsequent petition is filed, it will be important for the petitioner to explain, to the

---

<sup>1</sup> The claimed shampoo composition included derivatives of guar, which is a gum. The derivatives are used in food, drugs, and cosmetics. Some of them can be cationic, meaning they have electrical charges they can transfer.

extent it can, that the prior art was not “known and available” at the time of filing the first petition, and to make clear that new prior art *and* arguments differ significantly from the prior art and arguments of any past petitions.

*The Leahy-Smith America Invents Act established new patent post-issuance proceedings, including the inter partes review, post grant review and transitional program for covered business method patents, that offer a less costly, streamlined alternative to district court litigation. With the U.S. Patent and Trademark Office’s Patent Trial and Appeal Board conducting a large and increasing number of these proceedings, and with the law developing rapidly, Banner & Witcoff will offer weekly summaries of the board’s significant decisions and subsequent appeals at the U.S. Court of Appeals for the Federal Circuit.*



[www.bannerwitcoff.com](http://www.bannerwitcoff.com)

© Copyright 2014 Banner & Witcoff, Ltd. All Rights Reserved. The opinions expressed in this publication are for the purpose of fostering productive discussions of legal issues and do not constitute the rendering of legal counseling or other professional services. No attorney-client relationship is created, nor is there any offer to provide legal services, by the publication and distribution of this edition of PTAB Highlights.



**PTAB Refuses to Give Petitioner a  
Second Chance to Articulate  
Reasons for Invalidity**

**Craig W. Kronenthal**

***Banner & Witcoff PTAB Highlights***

**November 10, 2014**

BANNER&WITCOFF

# PTAB HIGHLIGHTS

New developments in post-issuance proceedings

[bannerwitcoff.com](http://bannerwitcoff.com)

## PTAB Refuses to Give Petitioner a Second Chance to Articulate Reasons for Invalidity

By [Craig W. Kronenthal](#)

November 10, 2014 – In a decision denying institution of *inter partes* review, the PTAB executes its discretion under 35 U.S.C. § 325(d) to refuse to give a petitioner a second chance to provide invalidity arguments.

[IPR2014-01080 – Zimmer Holdings, Inc. and Zimmer, Inc. v. Bonutti Skeletal Innovations LLC \(Paper 17, October 31, 2014\)](#)

In a prior case, the petitioner filed a petition requesting *inter partes* review of several claims of a patent. The Board instituted *inter partes* review for all but one of the challenged claims. With respect to the excluded claim, the Board found that the petitioner did not demonstrate a reasonable likelihood of prevailing because the petitioner’s obviousness arguments merely addressed why the references would have been combined by asserting that the references are analogous art. In this case, the petitioner filed a second petition requesting *inter partes* review of the previously excluded claim and a motion seeking joinder of this case with the prior case.

In this case, the petitioner sought to remedy its insufficient arguments by providing additional reasoning to show obviousness. The Board noted that the asserted ground of unpatentability in this case is the same as that in the prior case. The Board also pointed out that the “Petitioner simply presents an argument now that it could have made in [the prior case], had it merely chosen to do so.” The Board characterized the request for this *inter partes* review as a request for “a second chance,” and rejected the petitioner’s policy argument that it was in the public’s interest to have the claim invalidated. Instead, the Board cited 37 C.F.R. § 42.1(b) (which emphasizes the goal of securing a “just, speedy, and inexpensive resolution of every

proceeding”) and explained that “permitting second chances...ties up the Board’s limited resources.” The Board then exercised its discretion to decline to institute *inter partes* review for the previously excluded claim under 35 U.S.C. § 325(d), which allows the Office to reject a request because “the same or substantially the same prior art or arguments previously were presented to the Office.”

*The Leahy-Smith America Invents Act established new patent post-issuance proceedings, including the inter partes review, post grant review and transitional program for covered business method patents, that offer a less costly, streamlined alternative to district court litigation. With the U.S. Patent and Trademark Office’s Patent Trial and Appeal Board conducting a large and increasing number of these proceedings, and with the law developing rapidly, Banner & Witcoff will offer weekly summaries of the board’s significant decisions and subsequent appeals at the U.S. Court of Appeals for the Federal Circuit.*



[www.bannerwitcoff.com](http://www.bannerwitcoff.com)

© Copyright 2014 Banner & Witcoff, Ltd. All Rights Reserved. The opinions expressed in this publication are for the purpose of fostering productive discussions of legal issues and do not constitute the rendering of legal counseling or other professional services. No attorney-client relationship is created, nor is there any offer to provide legal services, by the publication and distribution of this edition of PTAB Highlights.





**PTAB Follows District Court's Claim  
Construction**

**Craig W. Kronenthal**

***Banner & Witcoff PTAB Highlights***

**November 10, 2014**

BANNER&WITCOFF

# PTAB HIGHLIGHTS

New developments in post-issuance proceedings

[bannerwitcoff.com](http://bannerwitcoff.com)

## PTAB Follows District Court's Claim Construction

By Craig W. Kronenthal

November 10, 2014 – In construing a term in a claim of an expired patent, the PTAB followed the district court in adopting the petitioner's proposed construction.

[IPR2014-00694 – \*Visa Inc. v. Leon Stambler\* \(Paper 10, October 31, 2014\)](#)

The petitioner filed a petition requesting *inter partes* review of an expired patent. In its petition, the petitioner proposed a construction for a particular claim term. In its preliminary response, the patent owner contested this construction and offered a different construction for the same term. The Board noted that its review of claims in an expired patent is similar to that of a district court's review where claims are construed to give words their ordinary and customary meaning as opposed to construing claims under the broadest reasonable interpretation standard typically applied by the Patent Office for unexpired patents.

After briefly identifying portions of the specification related to the disputed claim term, the Board turned to the claim constructions of the disputed term by district courts. The Board acknowledged that the District Court for the Eastern District of Texas adopted the construction proposed by the petitioner and that other district courts had adopted similar constructions for the disputed term. These district court decisions seemed to heavily influence the Board's decision to adopt the petitioner's proposed claim construction for purposes of deciding whether to institute *inter partes* review. Although the Board followed the district court in accepting the petitioner's proposal, the Board ultimately declined to institute the *inter partes* review.

*The Leahy-Smith America Invents Act established new patent post-issuance proceedings, including the inter partes review, post grant review and transitional program for covered business method patents, that offer a less costly, streamlined alternative to district court litigation. With the U.S. Patent and Trademark Office's Patent Trial and Appeal Board conducting a large and increasing number of these proceedings, and with the law developing rapidly,*

*Banner & Witcoff will offer weekly summaries of the board's significant decisions and subsequent appeals at the U.S. Court of Appeals for the Federal Circuit.*



[www.bannerwitcoff.com](http://www.bannerwitcoff.com)

© Copyright 2014 Banner & Witcoff, Ltd. All Rights Reserved. The opinions expressed in this publication are for the purpose of fostering productive discussions of legal issues and do not constitute the rendering of legal counseling or other professional services. No attorney-client relationship is created, nor is there any offer to provide legal services, by the publication and distribution of this edition of PTAB Highlights.



**Don't Forget Indefiniteness as a  
Ground for Invalidation in a CBM  
Patent Review**

**H. Wayne Porter**

***Banner & Witcoff PTAB Highlights***

**December 19, 2014**

BANNER&WITCOFF

# PTAB HIGHLIGHTS

New developments in post-issuance proceedings

[bannerwitcoff.com](http://bannerwitcoff.com)

## Don't Forget Indefiniteness as a Ground for Invalidation in a CBM Patent Review

By [H. Wayne Porter](#)

December 19, 2014 – The PTAB recently instituted a covered business method patent review (CBM) based on grounds that include asserted indefiniteness under 35 U.S.C. § 112, second paragraph.

[CBM2014-001146 – DealerSocket, Inc. v. AutoAlert, Inc.](#)

A CBM, which is authorized under Section 18(a) of the America Invents Act, allows a party sued for (or charged with) infringement of a “covered business method” patent to file a petition with the USPTO asking the Patent Trial and Appeal Board (PTAB) to invalidate one or more claims. Unlike an *Inter Partes* Review (IPR), which limits validity challenges to those based on a certain subset of prior art (i.e., patents and printed publications), a CBM allows validity challenges on numerous bases. For example, patentability under 35 U.S.C. § 101 has been raised in numerous CBMs, particularly in view of the June 2014 Supreme Court decision in *Alice Corp. v. CLS Bank Int'l*, 134 S. Ct. 2347.

Another ground that can be raised in a CBM, and that was also the subject of a recent Supreme Court decision, is indefiniteness under 35 U.S.C. § 112, second paragraph. In its June 2014 decision in *Nautilus, Inc. v. Biosig Instruments, Inc.*, 134 S. Ct. 2120, 2124, the Court held that a claim is indefinite if its language, when “read in light of the specification delineating the patent, and the prosecution history, fail to inform, with reasonable certainty, those skilled in the art about the scope of the invention.” In a December 9, 2014, decision to institute a CBM, the PTAB cited this standard and found that certain claims of U.S. Patent 8,086,529 are more likely than not indefinite.

The '529 patent relates to methods associated with vehicle financing. Relevant portions of claim 1 are as follows:

A method comprising:

automatically accessing . . . at least a portion of first financial terms that a customer has for a first vehicle and first vehicle information;

automatically accessing . . . at least a portion of second vehicle information for a second vehicle and second financial terms available to the customer for the second vehicle . . .

determining . . . whether . . . changed information *may affect whether it is favorable* for the customer to replace a first vehicle and first financial terms with a second vehicle and second financial terms. . . [italics added]

The PTAB found the petitioner established that the italicized language was, more likely than not, indefinite. The PTAB noted that the phrase includes two terms of degree: “may affect” and “favorable.” With regard to “may affect,” the PTAB stated that the ‘529 specification provides no objective standard to determine the boundary between “affect” and “may affect,” further noting that “[w]hat one regards as ‘may affect’ may not be so for another, particularly if that which is affected is itself subjective, such as a favorability determination.” With regard to “favorable,” the PTAB noted that “a particular customer may consider that it is *favorable* to have a new car and a lower monthly payment, whereas a different customer may view such a financial term as *unfavorable* because his or her obligation to make the monthly payments would be extended for many years” (italics in original).

Of course, the PTAB decision is only a determination that trial will go forward. The petitioner will still have to prove that the claims at issue are indefinite, and trial was also instituted on other grounds (i.e., claims directed to ineligible subject matter under 35 U.S.C. § 101, lack of written description under 35 U.S.C. § 112, first paragraph). However, the decision is a notable example of how a CBM can offer a wider range of validity challenge options than an IPR.

*The Leahy-Smith America Invents Act established new patent post-issuance proceedings, including the inter partes review, post grant review and transitional program for covered business method patents, that offer a less costly, streamlined alternative to district court litigation. With the U.S. Patent and Trademark Office’s Patent Trial and Appeal Board conducting a large and increasing number of these proceedings, and with the law developing rapidly, Banner & Witcoff will offer weekly summaries of the board’s significant decisions and subsequent appeals at the U.S. Court of Appeals for the Federal Circuit.*



[www.bannerwitcoff.com](http://www.bannerwitcoff.com)

© Copyright 2014 Banner & Witcoff, Ltd. All Rights Reserved. The opinions expressed in this publication are for the purpose of fostering productive discussions of legal issues and do not constitute the rendering of legal counseling or other professional services. No attorney-client relationship is created, nor is there any offer to provide legal services, by the publication and distribution of this edition of PTAB Highlights.

# **PROSECUTION**



**Functional Claiming**

**Bradley C. Wright**

***9th Annual Advanced Patent Law  
Institute***

**January 23-24, 2014**



**Presented:**  
9th ANNUAL ADVANCED PATENT LAW INSTITUTE

JANUARY 23-24, 2014  
ALEXANDRIA, VA

# **FUNCTIONAL CLAIMING**

**Bradley C. Wright**

Author contact information:  
Bradley C. Wright  
BANNER & WITCOFF, LTD  
1100 13th Street, N.W.  
Washington, DC 20005  
[www.bannerwitcoff.com](http://www.bannerwitcoff.com)

[bwright@bannerwitcoff.com](mailto:bwright@bannerwitcoff.com)  
202-824-3160

## FUNCTIONAL CLAIMING

The term “functional claiming” encompasses two distinct concepts under U.S. patent law. The first is expressly provided for by statute – specifically, 35 U.S.C. § 112(f)<sup>1</sup> – which provides that an element in a claim may be expressed as a means or step for performing a specified function without reciting structure in the claim. This so-called “means plus function” claiming has, over the years, lost favor as courts have applied increasingly narrow interpretations to such claims and have imposed increasing burdens on the use of such claims.<sup>2</sup> But “functional claiming” also refers more generally to claiming parts of an invention by what they do (their functions), rather than reciting their structure. This paper is primarily concerned with the latter method of claiming.

Beyond the requirements for novelty and nonobviousness, the patent statute requires that inventions be claimed in such a way as to be supported and enabled by the written description of the invention.<sup>3</sup> It also requires that inventions be claimed with particularity.<sup>4</sup> Nothing in the patent statute prohibits an invention from being claimed using “functional” language. But a review of the case law suggests that the use of so-called “functional” language in a patent claim may increase the likelihood that the claim will be held unpatentable or invalid. Consider the following hypothetical claim:

Claim 1: An apparatus configured to:  
receive a satellite signal;  
process the signal to detect a synchronization indicator;  
extract the synchronization indicator; and  
display the synchronization indicator on a display device.

Why would anyone want to draft such a patent claim? The natural reason is that it is exceedingly broad in scope.<sup>5</sup> This claim, if granted, would apparently cover any and every apparatus that is “configured to” perform the functions recited in the body of the claim. It would be exceedingly difficult to design around such a claim unless the functions of the accused device were different from those recited in the claim. Yet the validity or scope of such a claim -- and similarly “functional” claims -- might be subject to attack on a number of grounds, each of which is discussed separately below.

---

<sup>1</sup> References to the patent statute are to the version enacted by the Leahy-Smith America Invents Act of 2011.

<sup>2</sup> See, e.g., *Drafting Patents for Litigation and Licensing* 2d ed., Bloomberg BNA (Bradley C. Wright, editor-in-chief), Chapter 2 § III.E (Pitfalls of Means-Plus-Function Claims).

<sup>3</sup> 35 U.S.C. § 112(a).

<sup>4</sup> 35 U.S.C. § 112(b).

<sup>5</sup> Another reason to claim inventions “functionally” is that there may be no easy way to claim certain features based on their structure.

**I. Failure of Enablement or Written Description –  
Scope of Claim Exceeds Scope of Disclosure**

A first line of attack would be to challenge the validity of the hypothetical claim on the basis that it is not fully enabled, or that it lacks sufficient written description support in the specification. Because the hypothetical claim purports to include every type of apparatus that performs the recited functions, its breadth is likely not commensurate in scope with the scope of the structures disclosed in the specification for performing such functions. In *LizardTech, Inc. v. Earth Resource Mapping, Inc.*,<sup>6</sup> the Federal Circuit held that a patent claim was invalid on the basis that it was broader than was enabled by or described in the patent specification.<sup>7</sup>

LizardTech’s patent specification repeatedly described a compression process as “seamless,” and the prosecution history also emphasized that it was “seamless.” According to the Federal Circuit, the specification only described a single way of performing a “seamless” compression, but that single way was not recited in the claim at issue. The court stated that “a person of skill in the art would not understand how to make a seamless DWT generically and would not understand LizardTech to have invented a method for making a seamless DWT, except by ‘maintaining updating sums of DWT coefficients,’”<sup>8</sup> a feature that was not recited in the claim. Therefore, the claim was held to be invalid because the full breadth of the claim scope was not enabled.

Judge Bryson, writing for the court, drew an analogy to claiming an automobile engine:

By analogy, suppose that an inventor created a particular fuel-efficient automobile engine and described the engine in such detail in the specification that a person of ordinary skill in the art would be able to build the engine. Although the specification would meet the requirements of section 112 with respect to a claim directed to that particular engine, it would not necessarily support a broad claim to every possible type of fuel-efficient engine, no matter how different in structure or operation from the inventor’s engine. The single embodiment would support such a generic claim only if the specification would “reasonably convey to a person skilled in the art that [the inventor] had possession of the claimed subject matter at the time of filing” . . . and would “enable one of ordinary skill to practice ‘the full scope of the claimed invention.’”<sup>9</sup>

The Federal Circuit invalidated a claim based on a similar rationale in *National Recovery Technologies, Inc. v. Magnetic Separation Systems, Inc.*<sup>10</sup> As explained by the

---

<sup>6</sup> 424 F.3d 1336 (Fed. Cir. 2005).

<sup>7</sup> The court concluded that neither requirement was met. *Id.* at 1345.

<sup>8</sup> *Id.* at 1345.

<sup>9</sup> 424 F.3d at 1346.

<sup>10</sup> 166 F.3d 1190 (Fed. Cir. 1999).

court, “The case before us presents a classic example of a claim that is broader than the enablement as taught in the specification.”<sup>11</sup>

And in *Automotive Technologies International v. BMW of North America*,<sup>12</sup> a means-plus-function claim limitation that was asserted to cover both a mechanical sensor and an electronic sensor was held to be invalid because “the full scope [of the claim] must be enabled, and the district court was correct that the specification did not enable the full scope of the invention because it did not enable electronic side impact sensors.”<sup>13</sup> Although the patent specification provided a detailed description of a mechanical sensor, it provided only a cursory description of an electronic sensor, thus dooming the claim.

Given that the patent system was created to promote innovation by encouraging the disclosure of useful inventions to the public and promoting progress in the arts, the policy of invalidating “overly broad” claims would appear to further the goals of the patent system. If an inventor is able to develop a drug that cures cancer, for example, it seems unthinkable that he or she should be able to claim the drug by merely reciting “A drug having a composition that cures cancer.”<sup>14</sup> Such a broad claim, if upheld, would clearly stifle further innovation in the field of cancer research. Patent applicants therefore should be mindful of overreaching by claiming an invention using nothing more than functional language.<sup>15</sup>

## **II. Indefiniteness: Improper Mixing of Statutory Invention Categories**

A second possible attack on the hypothetical claim would be to allege that it is indefinite because it improperly mixes two statutory categories of invention – a machine (apparatus) and a method (process steps). More specifically, the preamble purports to define the statutory category of the invention as an apparatus, but the body of the claim recites only functions or steps.

The Federal Circuit invalidated a claim on that basis in *IPXL Holdings, L.L.C. v. Amazon.com, Inc.*<sup>16</sup> A dependent claim that recited “the system of claim 2 wherein . . . *the user uses the input means* to either change the predicted transaction information or accept the displayed transaction type and transaction parameters” was held to be indefinite and thus

---

<sup>11</sup> *Id.* at 1196.

<sup>12</sup> 501 F.3d 1274 (Fed. Cir. 2007).

<sup>13</sup> *Id.* at 1282.

<sup>14</sup> *See, e.g.,* Glaxo Wellcome, Inc. v. Eon Labs Mfg, 2002 WL 1874830 (S.D.N.Y. 2002) (unpublished) (invalidating a claim for a pharmaceutical drug, “[T]he claim defines the invention by the results achieved, rather than by the invention’s structure or ingredients. The structure by which the invention achieves sustained release at the claimed release rates is explained neither in the claim nor by plaintiff’s expert.”)

<sup>15</sup> *See also,* Boston Scientific Corp. v. Johnson & Johnson, 674 F.3d 1353, 1366 (Fed. Cir. 2011) (“Although it is true that functional claim language can meet the written description requirement when there is an established correlation between structure and function, Appellants fail to establish any such correlation.”); Billups-Rothenberg, Inc. v. Associated Regional and Univ. Pathologists, Inc., 642 F.3d 1031, 1037 (Fed. Cir. 2011) (“[T]he ‘681 patent contains only functional, not structural, characteristics of the predicted mutations.”); Ariad Pharm., Inc. v. Eli Lilly and Co., 598 F.3d 1336, 1350 (Fed. Cir. 2011) (“We have also held that functional claim language can meet the written description requirement when the art has established a correlation between structure and function.”)

<sup>16</sup> 430 F.3d 1377 (Fed. Cir. 2005).

invalid. Noting that “[w]hether a single claim covering both an apparatus and a method of use of that apparatus is invalid is an issue of first impression in this court,” the Federal Circuit held that the claim was indefinite because it was unclear whether infringement of the claim occurred upon creation of a system that allowed the user to perform the recited step, or whether infringement occurred only when the user actually used the claimed apparatus in the recited manner.<sup>17</sup>

A district court invalidated two patent claims because they improperly mixed apparatus and method categories of invention. In *HTC Corp. v. ICom GMBH & Co., KG*,<sup>18</sup> the invention related to a synchronization technique for mobile telephones. Claim 1 of the patent recited the following:

1. *A mobile station* for use with a network including a first base station and a second base station *that achieves a handover* from the first base station to the second base station *by:*

*storing* link data for a link in a first base station,

*holding* in reserve for the link resources of the first base station, and

when the link is to be handed over to the second base station:

initially *maintaining* a storage of the link data in the first base station,

initially *causing* the resources of the first base station to remain held in reserve, and

at a later timepoint determined by a fixed period of time predefined at a beginning of the hand-over, *deleting* the link data from the first base station and freeing up the resources of the first base station, the mobile station comprising:

an arrangement for reactivating the link with the first base station if the handover is unsuccessful. [emphasis added]<sup>19</sup>

As can be seen in the italicized text above, the claim preamble begins by defining the invention in terms of an apparatus (a mobile station), but the body of the claim contains several functions or steps that appear to define a method. The court concluded that although this claim and another similar claim recited an apparatus, they also recited six method steps in a way that described the apparatus as actually performing the method. According to the court, “Claims One and Eighteen improperly claim both an apparatus and method steps and thus are indefinite and invalid.”<sup>20</sup> So the lesson from this case is that failure to recite

---

<sup>17</sup> *Id.* at 1384.

<sup>18</sup> 2010 WL 3338536 (D.D.C. Aug. 25, 2010), *rev'd*, 667 F.3d 1270 (Fed. Cir. 2012).

<sup>19</sup> *Id.* at \*22.

<sup>20</sup> *Id.* at \*26.

sufficient structure in an apparatus claim, while reciting primarily functions or steps in the claim, may lead to invalidity. For a contrary result, see *Toshiba Corp. v. Juniper Networks, Inc.*<sup>21</sup> Although the Federal Circuit ultimately reversed the district court’s decision in the HTC case,<sup>22</sup> the risk of an adverse judgment can be avoided by taking care during the claim drafting process.

The Federal Circuit revisited the mixed-category claim issue in *Microprocessor Enhancement Corp. v. Texas Instruments Inc.*<sup>23</sup> In that case, a method claim that recited many structural details of the system in which it was to be performed was held to be not invalid for indefiniteness on the ground that it impermissibly mixed two distinct classes of patentable subject matter. Similarly, an apparatus claim that recited several functions of the structural components was deemed to be not invalid on the same ground. The drafting structure of independent method claim 1 was as follows:

1. A method of executing instructions in a pipelined processor comprising:  
[structural limitations of the pipelined processor];  
the method further comprising:  
[method steps implemented in the pipelined processor].<sup>24</sup>

Independent claim 7 recited an apparatus (a “pipelined processor”) that recited various structural components, but it also recited certain functions performed by some of those structural components. For example, the claim recited “the conditional execution decision logic pipeline stage *performing a boolean algebraic evaluation* of the condition code and said conditional execution specifier *and producing* an enable-write with at least two states, true and false.”<sup>25</sup> It also recited “at least one write pipeline stage *for writing the results* of each instruction to specified destinations.”<sup>26</sup>

According to the Federal Circuit, “apparatus claims are not necessarily indefinite for using functional language . . . [f]unctional language may also be employed to limit the claims without using the means-plus-function format.”<sup>27</sup> The court explained that “[d]irect infringement of claim 1 is clearly limited to practicing the claimed method in a pipelined processor possessing the requisite structure.”<sup>28</sup> As to independent apparatus claim 7, the court noted the “functional” language but upheld its validity, explaining that it was “clearly

---

<sup>21</sup> 2006 WL 1788479 (D. Del. June 28, 2006) (apparatus claims drafted using “active functional language” rather than “passive language” nevertheless did not improperly recite a method of using that apparatus). See also, *SFA Sys., LLC v. 1-800-FLOWERS.COM, Inc.*, 940 F.Supp.2d 433, 454-55 (E.D. Tex. 2013) (rejecting invalidity attack on an apparatus claim that recited various steps such as “detecting,” “initiating,” “inferring,” “determining,” and “updating” – “The functional language merely describes the functional capability of the claimed structures.”).

<sup>22</sup> *HTC Corp. v. IPCom GmbH & Co.*, 667 F.3d 1270 (Fed. Cir. 2012).

<sup>23</sup> 520 F.3d 1367 (Fed. Cir. 2008).

<sup>24</sup> *Id.* at 1374.

<sup>25</sup> *Id.* at 1371.

<sup>26</sup> *Id.*

<sup>27</sup> *Id.* at 1375.

<sup>28</sup> *Id.*

limited to a pipelined processor possessing the recited structure and *capable* of performing the recited functions.”<sup>29</sup>

So the mere presence of both functional and structural features in the same claim will not lead to invalidity of the claim. Nevertheless, claim drafters should be careful when using functional language in apparatus claims in a way that might be argued to be indefinite.

### **III. Unintended Statutory Category of Invention**

A third potential attack on the hypothetical claim would be to redirect the statutory invention category to which it belongs. Patent attorneys frequently draft separate apparatus and method claims to target different categories of infringers. For example, method claims may be drafted in such a way that they are only infringed by the purchaser or end user of a device, whereas an apparatus claim may be drafted in such a way that it is infringed by a manufacturer of the accused device. In the hypothetical claim set forth earlier, the preamble purports to identify the claim as an apparatus claim, so that anyone who makes such an apparatus would be a target infringer. Yet the body of the claim recites only method steps. In other words, the patent attorney intended to draft a very broad apparatus claim using functional steps.

Under established precedent, not every claim preamble is given weight – i.e., the words in the preamble sometimes form no part of the infringement or validity inquiry and thus can be ignored for purposes of analyzing infringement or validity. One tenet of this precedent states that if the body of the claim recites a “structurally complete invention,” then the preamble is given no effect.<sup>30</sup> Given that the body of the hypothetical claim appears to recite a complete set of method steps, it is possible that a court might give the “apparatus” terminology in the preamble no weight, leaving the patent owner with a claim to a method, rather than to an apparatus claim as intended by the drafter of the claim.

### **IV. May the PTO Ignore “Functional” Features of Apparatus Claims?**

The PTO has taken the position that an apparatus claim must be *structurally distinguishable* from the prior art. See MPEP § 2114 (“While features of an apparatus may be recited either structurally or functionally, claims directed to an apparatus must be distinguished from the prior art in terms of structure rather than function. . . . Apparatus claims cover what a device is, not what a device does,” citing *In re Schrieber*<sup>31</sup> and *Hewlett-Packard Co. v. Bausch & Lomb Inc.*<sup>32</sup>). But the cases cited for that proposition contain no such rule that an apparatus claim must be “structurally distinguishable” over the prior art.

---

<sup>29</sup> *Id.* (emphasis in original).

<sup>30</sup> *Rowe v. Dror*, 112 F.3d 473, 478 (Fed. Cir. 1997) (“where a patentee defines a structurally complete invention in the claim body and uses the preamble only to state a purpose or intended use for the invention, the preamble is not a claim limitation.”). Other case law not cited here holds that preambles may be limiting in other circumstances.

<sup>31</sup> 128 F.3d 1473 (Fed. Cir. 1997).

<sup>32</sup> 909 F.2d 1464, 1468 (Fed. Cir. 1990).

Assuming that a PTO examiner were to apply that rule to the examination of the hypothetical claim above, it would seem to run afoul of established PTO practice. There do not, however, appear to be any Federal Circuit decisions invalidating a claim on that basis or ignoring functional limitations in apparatus claims.<sup>33</sup> In view of established precedent stating that “functional” limitations are permitted in apparatus claims, it does not appear that the PTO may ignore “functional” recitations in apparatus claims.

## V. Invalidity of Single-Means Claims

Although means-plus-function claiming is generally beyond the scope of this paper, one might wonder whether some of the potential pitfalls above could be avoided by using a broad means-plus-function claiming strategy. Consider a slightly revised version of the above hypothetical claim:

Claim 2: An apparatus comprising:  
means for receiving a satellite signal, processing the signal to detect a synchronization indicator, extracting the synchronization indicator, and displaying the synchronization indicator on a display device.

This hypothetical claim 2 recites exactly the same functions as the hypothetical claim 1 above, but it does so using the statutorily-sanctioned means-plus-function format. Suppose further that the patent specification discloses a “processor” as the structure corresponding to the functions recited in this means-plus-function clause. This would mean that the claim would apparently cover any and all processors – and equivalents thereof – that perform the functions recited in the body of the claim. Could this claim achieve a scope nearly as broad as claim 1 in terms of its functional reach and yet avoid possible invalidity attacks?

The Federal Circuit early on answered this question, and the answer is no. In *In re Hyatt*,<sup>34</sup> the inventor drafted the following claim, which was affirmed as unpatentable by the PTO’s Board of Patent Appeals and Interferences:

35. A Fourier transform processor for generating Fourier transformed incremental output signals in response to incremental input signals, said Fourier transform processor comprising  
*incremental means* for incrementally generating the Fourier transformed incremental output signals in response to the incremental input signals. [emphasis added]

---

<sup>33</sup> Some language in earlier CCPA cases might be read to suggest this. See *In re Danly*, 263 F.2d 844, 848 (CCPA 1959) (“Claims drawn to an apparatus must distinguish from the prior art in terms of structure rather than function.”); *In re Michlin*, 256 F.2d 317, 320 (CCPA 1958) (“It is well settled that patentability of apparatus claims must depend upon structural limitations and not upon statements of function.”). Cf. *In re Schreiber*, 128 F.3d 1473, 1478 (Fed. Cir. 1997) (“A patent applicant is free to recite features of an apparatus either structurally or functionally.”); *K-2 Corp. v. Salomon S.A.*, 191 F.3d 1356, 1363 (Fed. Cir. 1999) (“The functional language is, of course, an additional limitation in the [apparatus] claim.”)

<sup>34</sup> 708 F.2d 712-13 (Fed. Cir. 1983).



The Federal Circuit affirmed, holding that so-called “single means” claims do not comply with the enablement requirement. According to the Federal Circuit, “[t]he long-recognized problem with a single means claim is that it covers every conceivable means for achieving the stated result, while the specification discloses at most only those means known to the inventor.”<sup>35</sup>

This proposition might be questioned after the Federal Circuit’s later decision, *In re Donaldson Co.*,<sup>36</sup> in which the court stated that the PTO must interpret means-plus-function clauses in light of the corresponding structure described in the specification, rather than interpreting such clauses to cover every possible means that could perform the recited function. Under the *Donaldson* holding, it seems that the “incremental means” in *Hyatt* would not cover “every conceivable means” for performing the recited function, but only the structures – and equivalents thereof – described in the patent specification. Nevertheless, *Hyatt* has not been overturned or cabined by the Federal Circuit, and it apparently remains good law. And the Federal Circuit in *Hyatt* explained that *combination claims* drafted using means-plus-function format are not improper.<sup>37</sup> So, merely adding a second clause (even a means-plus-function clause) to the claim would appear to solve this problem.

Although *Hyatt* is still good law, a district court recently refused to invalidate a claim under the *Hyatt* rationale. In *CBT Flint Partners, LLC v. Return Path, Inc.*,<sup>38</sup> the asserted claim was as follows:

6. An apparatus for determining whether a sending party sending an electronic mail communication to an intended receiving party is an authorized sending party, the apparatus comprising:

*means in communication with a network for detecting an indication of an origin of an electronic mail communication initiated by the sending party and for comparing the indication to an authorization list to determine whether or not the sending part is an authorized sending party, the authorization list corresponding to a list of sending parties from whom the intended receiving party will receive electronic mail communications, wherein the computer, upon determining that a sending party is not an authorized sending party, calculates a fee to be charged to the unauthorized sending party. [emphasis added]*<sup>39</sup>

On its face, this claim appears to recite only a single “means,” as indicated by the italicized text appearing above. Nevertheless, the district court found that this was not a single-means claim. According to the court, “The key question is: what is a combination? . . . In this case, the ‘means’ described includes both means in communication with a network for detecting,

---

<sup>35</sup> *Id.* at 714.

<sup>36</sup> 16 F.3d 1189 (Fed. Cir. 1994).

<sup>37</sup> 708 F.2d at 715.

<sup>38</sup> 566 F.Supp.2d 1363 (N.D. Ga. 2008).

<sup>39</sup> *Id.* at 1367.

and a means for comparing any indication to an authorization list.”<sup>40</sup> The corresponding structure was argued by the patent owner to be “one or more computers in communication with each other.” Nevertheless, the court invalidated the claim on a different ground – it was indefinite because the inventor failed to disclose any specific corresponding structure in the specification to support the recited functions in the claim, assuming that the claim was interpreted to be in means-plus-function format.<sup>41</sup>

Care must be taken to avoid inadvertently drafting a “single-means” claim in view of established case law holding that a claim limitation may be interpreted to be a means-plus-function element even if the word “means” is not used.<sup>42</sup>

Given that *Hyatt* can be avoided by claiming at least two elements in combination, how might a claim drafter broadly draft a claim to cover an apparatus that performs the recited functions? Consider the following third version of hypothetical claim 1:

Claim 3: An apparatus comprising:

a processor, and  
a memory storing instructions that, when executed, cause the apparatus to  
    receive a satellite signal;  
    process the signal to detect a synchronization indicator;  
    extract the synchronization indicator; and  
    display the synchronization indicator on a display device.

Assume further that the term “processor” and “memory” have well-understood meanings in the art, and that the specification provides broad descriptions for what similar structures would fall within the definition of a “processor.” (An inventor can, after all, be his own lexicographer.) This claiming strategy is one used by the author of this paper and has resulted in numerous patents.

The format of claim 3 above would appear to avoid most of the problems identified above regarding “functional” claiming, and would appear to fall comfortably within the holding of the *Microprocessor Enhancement* case discussed earlier as not improperly mixing statutory invention categories.

## VI. Indefiniteness: Claiming Function Without Metrics

Sometimes the patent drafter may use an adjective or adverb in a claim to describe a property in functional, non-numeric terms. Although this problem is not implicated in the hypothetical claims discussed above, it may arise more commonly in the chemical, pharmaceutical, and biotechnology areas. For example, in *Halliburton Energy Services, Inc.*

---

<sup>40</sup> 566 F.Supp.2d at 1371-72.

<sup>41</sup> *Id.* at 1372.

<sup>42</sup> *See, e.g., Massachusetts Institute of Technology v. Abacus Software*, 462 F.3d 1344 (Fed. Cir. 2006) (“colorant selection mechanism” deemed to be a means-plus-function limitation).

*v. M-I LLC*,<sup>43</sup> the patent drafter used the term “fragile gel” in a claim directed to a drilling fluid. Because “fragile” is an adjective that defines a function or property of the claimed gel, it was attacked on the ground that the specification provided no meaningful definition of “fragile” that could be used to measure the scope of the claims.

The Federal Circuit agreed, concluding that “it is ambiguous as to the requisite degree of the fragileness of the gel, the ability of the gel to suspend drill cuttings (i.e., gel strength), and/or some combination of the two.”<sup>44</sup> The court cautioned that, “When a claim limitation is defined in purely functional terms, the task of determining whether that limitation is sufficiently definite is a difficult one that is highly dependent on context (e.g., the disclosure in the specification and the knowledge of a person of ordinary skill in the relevant art area).”<sup>45</sup> Seemingly providing advice to patent drafters, the court explained that “the patent drafter could have provided more specifics in this case, either with quantitative metrics as to how quickly the gel must break . . . and how strong the gel must be . . . .”<sup>46</sup>

## VII. Unintended Means-Plus-Function Clauses

Sometimes a patent drafter may employ functional language in a way that causes the PTO or a court to effectively convert it into a means-plus-function limitation. For example, in *Massachusetts Institute of Technology v. Abacus Software*,<sup>47</sup> the Federal Circuit interpreted the claimed “colorant selection mechanism” to be a means-plus-function limitation, even though it did not use the term “means.” The court noted that “the term ‘mechanism’ standing alone connotes no more structure than the term ‘means.’”<sup>48</sup> In another case, *Mas-Hamilton Group v. LaGard, Inc.*,<sup>49</sup> the Federal Circuit interpreted the phrase “lever moving element” also to be a means-plus-function clause, rejecting the patent owner’s argument that it could encompass any device that caused the lever to move. “LaGard’s claim, however, cannot be construed so broadly to cover every conceivable way or means to perform the function of moving a lever.”<sup>50</sup>

The PTO may also treat broad functional claim language having no clearly-defined structural elements as means-plus-function limitations. In 2011, the PTO published guidelines instructing examiners to treat phrases such as “module for,” “component for,” and “apparatus for” as means-plus function limitations.<sup>51</sup>

One consequence of having an unintended means-plus-function limitation in a claim is that, unless the specification clearly ties structure to the recited function, the claim might

---

<sup>43</sup> 514 F.3d 1244 (Fed. Cir. 2008).

<sup>44</sup> *Id.* at 1256.

<sup>45</sup> *Id.* at 1255.

<sup>46</sup> *Id.* at 1256 n.6.

<sup>47</sup> 462 F.3d 1344 (Fed. Cir. 2006).

<sup>48</sup> *Id.* at 1354.

<sup>49</sup> 156 F.3d 1206 (Fed. Cir. 1998).

<sup>50</sup> *Id.* at 1214.

<sup>51</sup> Supplementary Examination Guidelines for Determining Compliance with 35 U.S.C. 112 and for Treatment of Related Issues in Patent Applications, 76 Fed. Reg. 7162, 7167 (February 9, 2011).

be held invalid. *See, e.g., Default Proof Credit Card Systems, Inc. v. Home Depot U.S.A., Inc.*,<sup>52</sup> where the Federal Circuit explained that:

If one employs means-plus-function language in a claim, one must set forth in the specification an adequate disclosure showing what is meant by that language. If an applicant fails to set forth an adequate disclosure, the applicant has in effect failed to particularly point out and distinctly claim the invention as required by the second paragraph of section 112 . . . A structure disclosed in the specification qualifies as “corresponding” structure only if the specification or prosecution history clearly links or associates that structure to the function recited in the claim.<sup>53</sup>

### VIII. Functional Claiming is Not New

Attempts by inventors to broadly claim their inventions using functional language are not new. More than 150 years ago, the U.S. Supreme Court struck down a patent claim on such a basis in *O’Reilly v. Morse*.<sup>54</sup> In that dispute, Samuel B. Morse attempted to claim his telegraph invention using the following “functional” language:

Eighth. I do not propose to limit myself to the specific machinery or parts of machinery, described in the foregoing specification and claims; the essence of my invention being the use of the motive power of the electric or galvanic current, which I call electro-magnetism, however developed, for making or printing intelligible characters, letters, or signs, at any distances, being a new application of that power, of which I claim to be the first inventor or discoverer.”<sup>55</sup>

Although the claim covered many different means of performing telegraphic communication, the Supreme Court concluded that Morse did not describe how to make or use all such means, and the claim was thus held to be invalid.<sup>56</sup> A later U.S. Supreme Court decision went further, stating that “a patentee may not broaden his product claims by describing the product in terms of function.”<sup>57</sup>

More than one hundred years later, the Court of Customs and Patent Appeals (CCPA) endorsed “functional” claiming in *In re Swinehart*,<sup>58</sup> which involved a claim to a composition that was “transparent to infra-red rays.” The claim also recited that the composition was a “solidified melt” of two components having a particular chemical makeup. The PTO had rejected the claim on the basis that it was indefinite because it was “functional.” The CCPA reversed, holding that “there is no support, either in the actual holdings of prior cases or in

---

<sup>52</sup> 412 F.3d 1291 (Fed. Cir. 2005).

<sup>53</sup> *Id.* at 1298.

<sup>54</sup> 56 U.S. (15 How.) 62 (1853).

<sup>55</sup> *Id.* at 86.

<sup>56</sup> *Id.* at 119-20.

<sup>57</sup> *General Elec. Co. v. Wabash Appliance. Corp.*, 304 U.S. 364, 371 (1938).

<sup>58</sup> 439 F.2d 210 (CCPA 1971).

the statute, for the proposition, put forward here, that ‘functional’ language, in and of itself, renders a claim improper.”<sup>59</sup>

Nearly 30 years later, in *In re Schrieber*,<sup>60</sup> the Federal Circuit addressed a claim directed to a device for dispensing popped popcorn. The claim recited a top that allowed a user to dispense only a few kernels at a time, using the functional language “the taper of the top being uniform and such as to by itself jam up the popped popcorn before the end of the cone and permit the dispensing of only a few kernels at a shake.” The Federal Circuit explained that:

a patent applicant is free to recite features of an apparatus either structurally or functionally . . . . Yet, choosing to define an element functionally, i.e., by what it does, carries with it a risk. . . . [W]here the Patent Office has reason to believe that a functional limitation asserted to be critical for establishing novelty in the claimed subject matter may, in fact, be an inherent characteristic of the prior art, it possesses the authority to require the applicant to prove that the subject matter shown to be in the prior art does not possess the characteristic relied on.<sup>61</sup>

Other recent court decisions have upheld the use of such functional claim language as “configured to”<sup>62</sup> and “adapted to.”<sup>63</sup>

More recently, in *Microprocessor Enhancement Corp. v. Texas Instruments Inc.*,<sup>64</sup> a method claim reciting many structural details of the system in which it was to be performed was held to be not invalid for indefiniteness. Similarly, an apparatus claim that recited several functional steps was deemed to be not invalid on the same ground. In upholding the validity of the claims, the Federal Circuit explained that “apparatus claims are not necessarily indefinite for using functional language . . . . Functional language may also be employed to limit the claims without using the means-plus-function format.”<sup>65</sup>

So there is no *per se* rule proscribing functional claiming, as long as the other requirements of the patent statute have been met.<sup>66</sup>

---

<sup>59</sup> *Id.* at 213.

<sup>60</sup> 128 F.3d 1473 (Fed. Cir. 1997).

<sup>61</sup> *Id.* at 1478 (quoting *In re Swinehart*).

<sup>62</sup> *Collaboration Props., Inc. v. Tandberg ASA*, 2006 WL 1752140, 81 USPQ2d 1530 (N.D. Cal. 2006).

<sup>63</sup> *Power-One, Inc. v. Artesyn Tech., Inc.*, 599 F.3d 1343, 1348 (Fed. Cir. 2010) (“the terms ‘adapted to’ and ‘near’ are not facially vague or subjective. . . . The term ‘adapted to power’ means that the regulator is ‘capable of delivering power at the level required by the circuit.’”); *Central Admixture Pharm. Serv., Inc. v. Advanced Cardiac Solutions, P.C.*, 482 F.3d 1347 (Fed. Cir. 2007); *Mattox v. Infotopia, Inc.*, 2005 WL 1220506 (Fed. Cir. 2005) (unpublished).

<sup>64</sup> 520 F.3d 1367 (Fed. Cir. 2008).

<sup>65</sup> *Id.* at 1375.

<sup>66</sup> For a somewhat analogous problem involving process claims that fail to set forth any steps in the process, see MPEP § 2173.05(q) (“Attempts to claim a process without setting forth any steps involved in the process generally raises an issue of indefiniteness under 35 U.S.C. 112, second paragraph.”)

## IX. Is “Purely” Functional Claiming Permitted?

One might think that the principles for “functional claiming” have by now been fairly well settled. Claiming an invention by its function rather than its structure is permissible as long as certain requirements are met. First, the full scope of the claim must be enabled by the breadth of disclosure in the specification.<sup>67</sup> Second, the claim must not run afoul of the Federal Circuit’s *IPXL Holdings*<sup>68</sup> case, which held that a claim may be indefinite if it improperly mixes and matches two statutory classes of invention, such as a machine intertwined with a method of using that machine. Finally, the claim must not fall into the category of a “single-means” claim of the type encountered in *In re Hyatt*.<sup>69</sup>

But a recent precedential opinion by the PTO’s Board of Patent Appeals and Interferences may have called into question the extent to which “purely functional” claiming may be used. In *Ex Parte Miyazaki*,<sup>70</sup> an expanded five-member panel of the Board declared that “purely functional” claim language does not comply with the patent statute. Representative claim 15 of Miyazaki’s application appears below:

15. A large printer comprising:

*a sheet feeding area operable to feed* at least one roll of paper, at least one sheet of paper and at least one stiff carton toward a printing unit at which printing is performed thereon; and

a cover member, which covers a first feeding path for the roll of paper from above, and which supports at least one of the sheet of paper and the stiff carton from below to constitute a part of a second feeding path for the sheet of paper,

wherein the cover member extends linearly from an upstream portion thereof to a downstream portion thereof in connection with a direction in which at least one of the sheet of paper and the stiff carton is fed at the sheet feeding area, and

wherein the cover member is disposed between at least one of the sheet of paper and the stiff carton and the roll of paper at a location in the sheet feeding area at which the roll of paper is in a rolled shape.<sup>71</sup>

The Board entered a new ground of rejection for this claim under 35 U.S.C. § 112, first paragraph, on the basis that the claimed “sheet feeding area operable to feed” was “a purely

---

<sup>67</sup> See, e.g., *LizardTech, Inc. v. Earth Resource Mapping, Inc.*, 424 F.3d 1336 (Fed. Cir. 2005).

<sup>68</sup> *IPXL Holdings, L.L.C v. Amazon.com, Inc.*, 430 F.3d 1377 (Fed. Cir. 2005).

<sup>69</sup> 708 F.2d 712, 714 (Fed. Cir. 1983) (claim covered every conceivable means for achieving the stated result, but the specification disclosed only those means known to the inventors).

<sup>70</sup> 89 USPQ2d 1207, 2008 WL 5105055 (B.P.A.I. 2008).

<sup>71</sup> 2008 WL 5105055 at \*1.

functional recitation with no limitation of structure.”<sup>72</sup> The basis for the rejection was lack of enablement – i.e., the scope of the claim was insufficiently enabled.

The Board reached this decision by first revisiting the U.S. Supreme Court’s 1946 decision in *Halliburton Oil Well Cementing Co. v. Walker*,<sup>73</sup> wherein the Supreme Court held invalid an apparatus claim on the basis that it used a “means-plus-function” term that was purely functional. In that case, the Supreme Court had criticized “conveniently functional language at the exact point of novelty.”<sup>74</sup> The Board then noted that the sixth paragraph of 35 U.S.C. § 112 was enacted in response to *Halliburton*, allowing means-plus-function claiming to be used under certain circumstances.

But the Board also concluded that the Supreme Court’s policy proscribing “purely functional” claiming remained good law for claims that were not drafted in accordance with the new statutory scheme.<sup>75</sup> According to the Board:

This general prohibition against the use of “purely functional claim language” (and the more specific *Halliburton* rule) has not been completely eliminated. Rather, “purely functional claim language” is now permissible but only under the conditions of 35 U.S.C. § 112, sixth paragraph, i.e., if its scope is limited to the corresponding structure, material, or act disclosed in the specification and equivalents thereof.<sup>76</sup>

The Board also concluded that claims not drafted using means-plus-function format could run afoul of the so-called *Halliburton* rule – in other words, *Halliburton* had a broader reach than means-plus-function claims. The Board explained that

claims 15 and 26, which recite “a sheet feeding area operable to feed . . . ,” violate the rule set forth in *Halliburton*, because the claims are not limited by the application of 35 U.S.C. § 112, sixth paragraph, and they do not contain any additional recitation of structure. As such, these claims are unpatentable under 35 U.S.C. § 112, first paragraph, for lack of an enabling disclosure commensurate with the scope of the claims.<sup>77</sup>

Of some interest is the Board’s reliance on the Supreme Court’s 1946 *Halliburton* case but not more recent Federal Circuit cases involving “functional” claiming. As pointed out above, for example, the Federal Circuit earlier that year decided *Microprocessor Enhancement Corp. v. Texas Instruments Inc.*,<sup>78</sup> in which the court explained, “As this court recently stated, apparatus claims are not necessarily indefinite for using functional language . . . *Functional language may also be employed to limit the claims without using the means-plus-function*

---

<sup>72</sup> *Id.* at \*10.

<sup>73</sup> 329 U.S. 1 (1946).

<sup>74</sup> *Id.* at 8.

<sup>75</sup> Miyazaki, 2008 WL 5105055 at \*12-13.

<sup>76</sup> *Id.* at \*13.

<sup>77</sup> *Id.* at \*14.

<sup>78</sup> 520 F.3d 1367 (Fed. Cir. 2008).

*format.*<sup>79</sup> Although the Federal Circuit was addressing “functional” claim language in the context of the definiteness requirement of the patent statute, it is unclear whether the *Miyazaki* decision is consistent with *Microprocessor Enhancement*. At least two district courts have declined to follow it.<sup>80</sup>

Nor did the Board mention the CCPA’s seminal case of *In re Swinehart*,<sup>81</sup> discussed above, where the court clearly stated that, “there is no support, either in the actual holdings of prior cases or in the [Patent Act], for the proposition, put forward here, that ‘functional’ language, in and of itself, renders a claim improper,” and there is no “other ground for objecting to a claim on the basis of any language, ‘functional’ or otherwise, beyond what is already sanctioned by the provisions of 35 U.S.C. § 112.”<sup>82</sup>

More recently, another expanded panel of the Board decided *Ex Parte Rodriguez*,<sup>83</sup> holding that “configuration generator configured to generate,” a “system builder configured to build,” and a “simulation verification environment configured to verify” were purely functional recitations involving no known structures, and the claims were unpatentable on two different grounds: (1) failure to disclose corresponding structure in the specification, assuming that the claims were interpreted as means-plus-format clauses;<sup>84</sup> and (2) following *Miyazaki*, purely “functional” claiming without any recitation of specific structure.<sup>85</sup> According to the Board, “In contrast to the claim in *Swinehart*, Appellants’ claim recites no meaningful structure. *Instead, the scope of the functional claim language of claim 1 is so broad and sweeping that it includes all structures or means that can perform the function.*”<sup>86</sup>

Although the Federal Circuit has not yet addressed this specific issue – i.e., whether “functional claiming” without any recitation of recognized structures renders a claim invalid or unpatentable – patent applicants would be well-advised to steer clear of apparatus claims that recite little or no recognized structural elements while reciting functions.<sup>87</sup> At least before the PTO, such claims are unlikely to make it out into the real world.

### Conclusion

Until the Federal Circuit provides more guidance as to whether there are any limits to “functional” claiming, patent applicants and litigants should keep in mind several basic principles when drafting or asserting claims involving functional language.

---

<sup>79</sup> *Id.* at 1375.

<sup>80</sup> *American Med. Sys., Inc. v. Laser Peripherals, LLC*, 712 F.Supp.2d 885, 910 (D. Minn. 2010) (rejecting a “purely functional” invalidity attack on the claims). See also, *Markem-Imaje Corp. v. Zipher Ltd.*, 2012 WL 3263517 at n.4 (D.N.H.).

<sup>81</sup> 439 F.2d 210 (CCPA 1971).

<sup>82</sup> *Id.* at 213.

<sup>83</sup> 92 USPQ2d 1395, 2009 WL 3756279 (B.P.A.I. 2009).

<sup>84</sup> 92 USPQ2d at 1406.

<sup>85</sup> *Id.* at 1409-11.

<sup>86</sup> *Id.* at 1409.

<sup>87</sup> Whether a particular element is a recognized structural element or not can, of course, be fact-specific. See, e.g., *The Chamberlain Group, Inc. v. Lear Corp.*, 2010 WL 4884448 at \*34 (N.D. Ill. Nov. 24, 2010) (rejecting the argument that “generator” is a means-plus-function element and distinguishing *Ex Parte Rodriguez*).



First, the enablement requirement may impose limits to overly-broad functional claiming. As set forth in the hypothetical claim at the beginning of this paper, for example, claiming a machine solely by reciting the functions it performs without reciting any structural elements may run afoul of that requirement. Adding dependent claims with varying levels of structural detail may provide a fall-back validity position for aggressive functional claiming strategies.

Second, when prosecuting applications before the PTO, it may be more difficult to procure patents involving “functional” elements unless at least *some* structural elements are claimed in combination with the functions. And the structural elements must correspond to recognized or known structures, not generic elements that have no corresponding real-world meaning.

Third, when drafting functional limitations in combination with structural features, care should be taken to avoid running afoul of the *IPXL Holdings* case, which was found to improperly mix an apparatus claim with a method of using the apparatus.

Finally, while means-plus-function claiming is generally beyond the scope of this paper, single-means claims are still not permitted under controlling precedent and should be avoided. Because claim limitations that omit the word “means” nevertheless may be interpreted as a means-plus-function limitation,<sup>88</sup> care should be taken to avoid inadvertently drafting such a claim.

---

<sup>88</sup> See, e.g., *Massachusetts Institute of Technology v. Abacus Software*, 462 F.3d 1344 (Fed. Cir. 2006) (“colorant selection mechanism” deemed to be a means-plus-function limitation).



**The Federal Circuit Upholds *Cybor's*  
Rule That Claim Construction is  
Subject to *De Novo* Appellate  
Review**

**R. Gregory Israelsen**

***Banner & Witcoff Intellectual  
Property Alert***

**February 24, 2014**



## Intellectual Property Alert: The Federal Circuit Upholds *Cybor*'s Rule that Claim Construction Is Subject to *De Novo* Appellate Review

By R. Gregory Israelsen

Feb. 24, 2014 — On Friday, the Federal Circuit reaffirmed 6–4 in *Lighting Ballast Control LLC v. Philips Electronics North America Corp.*, that its holding in *Cybor Corp v. FAS Technologies* is still good law. In short, patent claim construction is a purely legal issue that is subject to *de novo* review on appeal. Judge Newman authored the majority opinion, which rested largely on principles of stare decisis. Judge Lourie joined the majority and authored a concurrence. Judge O'Malley offered a strong dissent. This was a high-profile case in intellectual property circles, as 38 individuals and organizations — including three Banner & Witcoff attorneys — had filed 21 amicus briefs.

### **Background**

The United States Court of Appeals for the Federal Circuit granted en banc review of a petition filed by Lighting Ballast Control to reconsider the standard of appellate review given to district-court interpretations of the meaning and scope of patent claims (claim construction). The Federal Circuit had previously held in *Cybor* that patent claim construction receives *de novo* review for correctness as a matter of law.

### **Majority Opinion**

The majority opinion rested primarily on principles of stare decisis. The court decided *Cybor* in 1998 — 15 years ago. *Cybor*'s approach also avoided unnecessarily complicating patent litigation. And *Cybor*'s detractors offered no better alternative.

The majority repeatedly emphasized the importance of stability in the law. Because stare decisis is of “fundamental importance to the rule of law,” a departure from a previous decision’s approach requires “compelling justification.” Departure from precedent may be appropriate when later cases “undermine [a precedent’s] doctrinal underpinnings,” when the precedent has proved “unworkable,” or when “a considerable body of new experience” requires changing the law. The majority found no judicial or legislative cases that would justify departing from *Cybor*, and it did not consider *Cybor*'s approach to be unworkable. Further, no better alternative has been found.

The majority also discussed the benefits of *Cybor*'s approach. "Claim construction is a legal statement of the scope of the patent right," a question that is not dependent on a witness's credibility, but rather the contents of the patent itself. As is, the Federal Circuit can resolve claim construction definitively as a matter of precedent, rather than allow different trial court constructions of the same patent. In other words, because the Federal Circuit reviews claim construction *de novo*, the court resolves the meaning and scope of a patent claim for uniform application throughout the nation, as a matter of law.

The majority also reasoned that overturning *Cybor* would be difficult in practice. Recognizing a fact-law distinction in claim construction would add another complicated layer to litigation. Parties would dispute which elements of claim construction are factual questions subject to deference and which elements are legal questions to be reviewed *de novo*. Further, a new approach would be unlikely to change actual outcomes, as only a small number of disputes even arguably present factual questions in claim construction. The majority pointed out that "amicus curiae United States could not identify any case that would have come out differently under the modified (hybrid) standard of review it proposed." Therefore, the majority was reluctant to impose an "amorphous standard" of appellate review on claim construction that would not "produce a better or more reliable or more accurate or more just determination of patent claim scope."

Finally, the majority remarked on the dissent's arguments. Doing so inherently acknowledged the dissent's point that the Federal Circuit's "internal debate over *Cybor* has been heated, and has not abated over time." The majority argued that the dissent's approach would make deference "of central significance in controlling the determination of claim construction, and hence of patent scope. The consequence would be heightened forum-shopping and the inability of the judicial system to arrive at a uniform, settled meaning for a patent's scope." According to the majority, the dissent offered no superior alternative to *de novo* review, nor any workable standard for distinguishing between legal and factual components of claim construction.

### **Concurrence**

Judge Lourie authored a brief concurrence making additional arguments for keeping *Cybor*'s standard. The problem with claim construction is not a lack of deference to a lower court's findings, but rather "the multiplicity of actors contending in a competitive economy." Inventors have the idea, patent attorneys draft the patent and claims, potentially different patent attorneys negotiate those claims with one or more examiners during prosecution, and another set of attorneys debate those claims in litigation. Thus, the actors in court are often different than those who made the invention, created the patent, and knew what it meant.

Further, Judge Lourie argued, "no deference" does not really mean "no deference." According to Judge Lourie, the Federal Circuit should, and does, give "informal deference to the work" of

district court judges and affirms when appropriate. Even if the standard were formally changed, “judgments of subordinate courts are still not unreviewable.” In short, changing *Cybor* would simply be “a cosmetic public” exercise with no actual change in practice.

### **Dissent**

Judge O’Malley authored a strong dissent, joined by Chief Judge Rader and Judges Reyna and Wallach.

The dissent was clearly dissatisfied with several members of the majority, two of whom “have been among the harshest critics of *Cybor*,” and a third who “conceded that *Cybor*’s rule may be too broad.” Further, the dissent asserted that “not once during [the Federal Circuit’s] internal dialogue over the rule promulgated in *Cybor* did anyone contend that stare decisis alone should put an end to our debate.” The majority responded to the dissent: “[I]t is comforting to know that our golden words of the past are not forgotten.” But “the court is not now deciding whether to adopt a *de novo* standard,” but rather “whether to cast aside the standard that has been in place for fifteen years.”

The dissent argued that *Cybor*’s approach is flawed, at least in part because some of its underlying assumptions. The majority and several of the amici premised their opinions on the assumptions that only questions of law are subject to *de novo* review, and that questions of law are always subject to *de novo* review. The dissent refuted both of these arguments.

Questions of fact are often decided by judges. “Stating that something is better decided by the judge is not the same as saying it is a matter of law.” The dissent interpreted *Markman* to say “that judicial efficiencies supported allocation of claim construction determinations to the court rather than to the jury.” Therefore, it is not necessary to keep *Cybor* in order to keep claim construction in the hands of judges.

Furthermore, *Cybor*’s reliance on the “faulty premise that claim construction is a purely legal exercise” leads to its direct contravention of “the clear directives of Federal Rule of Civil Procedure 52(a)(6),” which requires that, on appeal, all “findings of fact . . . must not be set aside unless clearly erroneous.” There are no exceptions to the rule “with regard to fact-finding in the claim construction context.” For the dissent, that ended the question. “The fact that our inquiry might be a difficult one does not excuse the failure to undertake it.”

Finally, the dissent disputed the majority’s assumption that the Federal Circuit exercising *de novo* review of claim construction leads to better or more uniform results. In contrast to district court judges, who can spend hundreds of hours reviewing documents, receiving testimony, and even listening to tutorials on the relevant science, the Federal Circuit “lacks the resources to do it right.” And Federal Circuit decisions are often panel dependent. The dissent pointed to two cases

involving the same patent where different Federal Circuit panels determined two different meanings for “greater than 3% elasticity,” casting doubt on the majority’s claim that *de novo* review by the Federal Circuit of all claim construction would lead to more consistent outcomes.

### **Conclusion**

The Federal Circuit’s decision is not likely to put to rest the debate over the proper standard of review for patent claim construction. The majority opinion did not focus on the particular merits of *Cybor*’s approach, arguing instead that “those who would change *Cybor*’s system of plenary review of claim construction have not shown any benefit or advantage to the law or those served by the law.” Thus, academics and practitioners are likely to continue considering the question. Such discussion would most productively be focused on how “greater deference will produce any greater public or private benefit” than the current *Cybor* standard, and a workable alternative for implementing deferential review.

The Federal Circuit’s decision may be appealed to the Supreme Court, which has discretion whether to take up the case.

The full Federal Circuit decision is available at [\*Lighting Ballast Control LLC v. Philips Electronics North America Corp.\*, No. 2012-1014, slip op. \(Fed. Cir. Feb 21, 2014\)](#). See also *Cybor Corp. v. FAS Technologies, Inc.*, 138 F.3d 1448 (Fed. Cir. 1998) (en banc).

To subscribe or unsubscribe to this Intellectual Property Advisory,  
please send a message to Chris Hummel at [chummel@bannerwitcoff.com](mailto:chummel@bannerwitcoff.com)



[www.bannerwitcoff.com](http://www.bannerwitcoff.com)

© Copyright 2014 Banner & Witcoff, Ltd. All Rights Reserved. The opinions expressed in this publication are for the purpose of fostering productive discussions of legal issues and do not constitute the rendering of legal counseling or other professional services. No attorney-client relationship is created, nor is there any offer to provide legal services, by the publication and distribution of this edition of IP Alert.



**Supreme Court Justice Characterizes  
*Alice v. CLS Bank* as Being on the  
Idea of “Solvency,” or “Computer,  
Stop”**

**Charles W. Shifley**

***Banner & Witcoff Intellectual  
Property Alert***

**April 2, 2014**



## Intellectual Property Alert: Supreme Court Justice Characterizes *Alice v. CLS Bank* as Being on the Idea of “Solvency,” or “Computer, Stop;” While All Justices Search Among King Tut, Scylla, Charybdis and Archimedes for Inspiration

By Charles W. Shifley

April 2, 2014 — The U.S. Supreme Court heard oral argument on March 31 in *Alice v. CLS Bank*, the much anticipated case concerning whether inventions executed on computers are patent-eligible subject matter under the “abstract idea” test.

In *Alice*, the petitioner Alice is a patent owner whose invention was found not patent-eligible at the district court and Federal Circuit. It sought to convince the Supreme Court that its process and system claims to intermediated settlements in trading situations are patent-eligible. The invention faced an uphill battle at the Supreme Court.

### **Alice argues for its patent**

The petitioner’s argument in *Alice* began with counsel Carter Phillips asserting that the only issue to be resolved was whether the existing standard against the patenting of natural phenomena, laws of nature and abstract ideas applied. Justice Breyer, author of *Mayo v. Prometheus* and author of a concurring opinion in *Bilski v. Kappos*, immediately interjected that intermediate settlement was no different than the hedging found ineligible for patenting in *Bilski*. Interestingly, Mr. Phillips conceded that if the patent in suit claimed intermediated settlements, it would not have a distinction from *Bilski*. But he also conceded that with the idea of the patent in hand, a second-year college class in engineering could program the idea over the weekend.

Justice Breyer proceeded to compare the idea to King Tut hiring a man with an abacus to keep track of King Tut giving away chits of gold. Upon seeing on his abacus that a limit had been reached, the “abacist” would say “stop.” He then compared the invention to the same thing with a grain elevator, reservoir of water and his checkbook — the checkbook watched by his mother. To him, the invention was simply maintaining solvency, or meant to cover the command, “computer, stop.” Justice Sotomayor added that she also saw only a function of reconciling accounts, making sure they were paid on time.

Justice Scalia took an opposite tack, asserting that the cotton gin was comparable to the invention because the gin was simply doing through a machine what people once did by hand. But Justice Breyer reasserted himself, with candid words about the limits of Supreme Court decision-making. He stated that in *Mayo v. Prometheus*, he “couldn’t figure out much ... beyond what [he] thought was an obvious case, leaving it up to [the bench and bar] to figure out how to go further.” Mr.



Phillips asserted that the Court should consider all inventions patent-eligible so long as they do not state fundamental truths, or “simply say use a computer.” Justice Kennedy asked whether the invention could have been patented without mention of a computer, and Mr. Phillips again answered “absolutely not.” He then advocated that with his invention and “almost all software,” “any computer group of people sitting around a coffee shop in Silicon Valley could [write the code] over a weekend.”

Justice Breyer pointed out that 42 briefs had been filed in the case by the parties and amici. He stated they were helpful “up to the point where [the Court] has to make a decision.” The problem, he stated, is that if processes implemented on the computer are universally eligible for patent, then competition will not be on the basis of price, service and better production methods, but on who has the best patent lawyer. But on the other hand, if computer-implemented inventions are never patent-eligible, real inventions with computers are ruled out. The issue is “how to go between Scylla and Charybdis,” roughly, between a rock and a hard place.

Asked to step out of his client representation and give the Court advice, an odd request, Mr. Phillips advocated that in providing a covered business method procedure in the America Invents Act, Congress did not say “no” to business method patents. It instead intended to take the resolution of eligibility out of the courts and put it in the Patent Office. His advice, then, was that the Court liberally interpret 35 U.S.C. § 101, and leave the culling of appropriate business method patents to 35 U.S.C. §§ 102 and 103. However, Justice Ginsburg pointed out that four justices in *Bilski* did not liberally interpret the legislative history of 35 U.S.C. § 101 as he suggested. Diverting the argument, Justice Scalia stated that the Court had not concluded in its prior decisions that “you can’t take an abstract idea and then say here is how you implement it,” meaning, apparently, that he might find eligibility for computer implementations that required “how to” explanations.

### **CLS argues against the patent**

Mark Perry next appeared for CLS Bank. He immediately asserted that the path between Scylla and Charybdis was charted in *Bilski* and *Mayo*. *Bilski*, he said, held that a fundamental economic principle was an abstract idea, and *Mayo* held that running such a principle on a computer was “not a patentable application of that principle.” Dramatically he asserted, “If *Bilski* and *Mayo* stand, Alice’s patents fail.”

In response to questions posed by Justice Kennedy and Justice Sotomayor regarding exemplary business processes that were patentable, Mr. Perry provided examples including encryption technology, solutions to limitations on streaming video and certain e-mail and word processing technology. He further advocated that “only where the method will not work without a computer,” is there to be a patent. He also strongly asserted that blanket eligibility and blanket ineligibility for computer-implemented inventions are both wrong. The rule, he asserted, “will not be bright-line” and the Court must be “contextual,” “nuanced” and “look at things in a more robust way.”

*Mayo*, Mr. Perry asserted, stated: “Simply implementing a fundamental principle on a physical machine, namely a computer, is not a patentable application of that principle.” Asked why if the test was simple, the Federal Circuit struggled, Mr. Perry responded that the Federal Circuit includes a significant element that disagrees with *Mayo* and has been resistant to applying it. To retreat from the unanimous decision of *Mayo*, he asserted, “would reward intransigence, difficulty, refusal to adhere to

what are clear precedents.” Concluding, Mr. Perry asserted the problem was small, with only 57 district court decisions on 35 U.S.C. § 101 since *Bilski* and only 12 Federal Circuit decisions on computer implementation.

### **The forecast is for Alice loss**

Notable is that the patent owner, through Mr. Phillips, admitted there was no invention in the case in the software by which the intermediated settlements of the case was implemented. The computer implementation, he conceded, was the stuff of college class members programming over a weekend, or even weekend programming at a coffee shop. He combined this with agreeing that if the patent claimed intermediated settlement, the case result was to be just as in *Bilski*. This argument likely may doom the specific patent at issue. The Court will likely take the easy path and affirm that the invention of the patent is not patent eligible.

The transcript of the oral argument in *Alice v. CLS Bank* can be found [here](#).

To subscribe or unsubscribe to this Intellectual Property Advisory,  
please send a message to Chris Hummel at [chummel@bannerwitcoff.com](mailto:chummel@bannerwitcoff.com)



[www.bannerwitcoff.com](http://www.bannerwitcoff.com)

© Copyright 2014 Banner & Witcoff, Ltd. All Rights Reserved. The opinions expressed in this publication are for the purpose of fostering productive discussions of legal issues and do not constitute the rendering of legal counseling or other professional services. No attorney-client relationship is created, nor is there any offer to provide legal services, by the publication and distribution of this edition of IP Alert.



**Global PPH and IP5 — Latest  
Iteration in the Patent Prosecution  
Highway**

**Jordan N. Bodner and Erin E. Bryan**

***Banner & Witcoff Intellectual  
Property Update***

**April 21, 2014**

## GLOBAL PPH AND IP5 – LATEST ITERATION IN THE PATENT PROSECUTION HIGHWAY



BY: JORDAN N. BODNER AND ERIN E. BRYAN

The Patent Prosecution

Highway (also referred to as the “PPH”) embodies numerous bilateral agreements between dozens of countries providing that an indication of allowable subject matter in one country may trigger accelerated examination in another country. The PPH has undergone several iterations in an effort to homogenize aspects of the agreements. Nonetheless, inter-jurisdictional variations in legal and procedural requirements remain a sticking point for many practitioners who view the PPH as unnecessarily onerous and convoluted.

A recent iteration implemented January 6, 2014, came in the form of two programs — the so-called Global Patent Prosecution Highway (Global PPH) that promises to standardize the agreements between 17 offices in 16 countries, as well as the IP5 that standardizes agreements between the United States, the European Patent Office (EPO), Japan, China and Korea.

### A PPH PRIMER

The PPH provides accelerated examination of corresponding patent applications by sharing information between multiple patent offices. Once an applicant receives a ruling from an Office of First Filing (OFF) that at least one claim of an application is patentable, the applicant may request that an Office of Second Filing (OSF) fast track the examination of corresponding claims in a corresponding application filed in the OSF. Examination in the second office may be fast tracked to speed

up the examination process and thereby lower costs of the second application. Examination will typically begin within two to three months from the PPH petition being granted (as long as the preliminaries are completed), which provides a greater efficiency for examination.

An applicant is eligible to request expedited review through the PPH once allowable claims have been identified by the OFF. The claims of the application filed in the OSF must correspond to the allowable claims in the OFF application. Once an allowance has been received, the applicant may file a request for PPH in the OSF. If the applicant is filing an application with the U.S. Patent & Trademark Office (USPTO) as the OSF, then a petition to make special may be filed with the application. The petition should be filed before substantive examination at the OSF begins, however the request may be filed when the applicant chooses. Once the petition is accepted, the applications examination may be accelerated. The examiner at the OSF will examine the application in view of the local patent laws, but may utilize the OFF’s work product, including notice of allowance and/or search reports.

In a variation, the PCT-PPH program utilizes Patent Cooperation Treaty (PCT) work product as the basis for accelerated examination. For instance, depending upon the International Searching Authority being used, accelerated examination may be requested utilizing a Written Opinion established and/or an International Preliminary Examination Report.

Revised PPH requirements were published on July 15, 2011, as part of the so-called MOTTAINAI pilot program. Designed to

[MORE>](#)

make the PPH more useful (the Japanese word, “mottainai,” refers to a sense of regret from wasting a resource), this program was implemented by a number of patent offices.

Among other changes, the revisions implemented by the MOTTAINAI program eliminated the OFF and OSF relationship, broadened the definition of “sufficient correspondence,” and eased the requirements for entering the PPH. The OSF and OFF are now identified as an Office of Later Examination (OLE) and an Office of Earlier Examination (OEE), respectively. The OLE may use examination results of the OEE as long as the OLE and the OEE have an agreement on revised requirements and the applications have the same priority/filing date. The claims of the application must be the same or similar in scope, or the claims must be narrower.

### GLOBAL PPH AND IP5

On January 6, 2014, the Global PPH and IP5 programs were initiated. Both programs generally utilize the same criteria for examining applications and are only different as to which countries participate.

#### Global PPH

[USPTO \(US\)](#)

[JPO \(Japan\)](#)

[KIPO \(Korea\)](#)

[UKIPO \(United Kingdom\)](#)

[PRV \(Sweden\)](#)

[NPI \(Nordic Patent Institute\)](#)

[DKTPO \(Denmark\)](#)

[CIPO \(Canada\)](#)

[LPO \(Israel\)](#)

[SPTO \(Spain\)](#)

[IP Australia](#)

[HPO \(Hungary\)](#)

[ROSPATENT \(Russia\)](#)

[IPO \(Iceland\)](#)

[NBPR \(Finland\)](#)

[INPI \(Portugal\)](#)

[NIPO \(Norway\)](#)

#### IP5

[USPTO \(US\)](#)

[EPO \(Europe\)](#)

[SIPO \(China\)](#)

[JPO \(Japan\)](#)

[KIPO \(Korea\)](#)

In the participating offices, the Global PPH and IP5 programs supersede previous applicable versions of the PPH. For an application to be eligible for either the Global PPH or IP5 programs, the application filed at the OLE and the OEE must have:

- the same earliest priority date;
- the OEE must have allowed at least one claim;
- all of the claims presented for examination at the OLE must sufficiently correspond to the one or more claims found allowable by the OEE;
- the OLE must not yet have begun substantive examination of the application, and a request for substantive examination must have been filed at the OLE either at the time of the PPH request or earlier;
- depending on the OLE that the request is filed in, a petition fee may be required; and
- the OEE application must have been valid and must have been substantively examined for novelty and inventive step.

When filing a request under the Global PPH and IP5, the applicant must submit a completed request form, a copy of appropriate work product relevant to the allowability of the claims of the corresponding OEE application (for instance, examination reports, etc.), and a copy of the claims found to be allowable by the OEE if not available to the OLE. Additional information that may need to be submitted includes copies of citations raised against the OEE application if not available to the OLE, translations of any documents submitted and a claim correspondence table showing the relationship between the claims of the OLE application and the OEE application.

The Global PPH request will be considered promptly by the OLE and, if any deficiencies are identified, the applicant will be given at least one opportunity to correct the application within a specified period of time. Where a country participates in both the Global PPH and IP5 programs (i.e., the U.S., Japan and Korea), the applicant may file a PPH request based on work product of an office participating in either program.

Details of the Global PPH and IP5 programs may be found on the website of the USPTO at [www.uspto.gov/patents/init\\_events/pph/](http://www.uspto.gov/patents/init_events/pph/), and on the website of the JPO at [www.jpo.go.jp/ppph-portal/index.htm](http://www.jpo.go.jp/ppph-portal/index.htm). PPH request forms may be found at the corresponding OLE website.

## A SECOND LOOK

The Patent Prosecution Highway, in all its forms, has proven to be an effective tool, but may be more effective in certain countries. According to statistics provided by the JPO, the PPH can significantly improve both first action allowance rate and overall pendency of applications.

For instance, the first action allowance rate for a PPH (not including PCT-PPH) application versus all applications for the period of July to December 2013 was 27.1 percent versus 17.3 percent at the USPTO, 24 percent versus 16 percent in Japan, and 48.8 percent versus 10.5 percent in Korea.

And, during that same period, the pendency to final decision of such PPH applications versus all applications in the USPTO, Japan and Korea was, respectively, 4.4 months versus 18 months, 2 months versus 13 months, and 2.5 months versus 13.2 months.

Additional offices (e.g., UKIPO, IP Australia and others) have exhibited shortened application pendency, as well as an increase in first action allowance rate, while other offices (e.g., EPO) do not provide any statistics regarding pendency or first action allowance, making it difficult to quantify how effective the PPH is at the EPO.

Points to keep in mind when deciding whether to utilize the PPH include the potential for examiners to overlook possible application issues in an effort to expedite examination, which depending on the office, may have an effect on the presumption of validity of an allowed application. Additionally, the application at the OLE is limited to claims substantially the same as the claims from the OEE, so the application may be narrower in scope than if otherwise examined as a new application in each office. Finally, consider the possibility of integrating the PPH with other accelerated examination procedures at the OEE. For example, allowed claims in a U.S. patent application filed using Track 1 prioritized examination procedures may be used as the basis for PPH filings in other countries.

With revisions such as MOTTAINAI and PCT-PPH, and now the Global PPH and IP5 programs, the PPH is evolving and may be worth a second look as a tool to be used in your practice. ■

Points to keep in mind when deciding whether to utilize the PPH include the potential for examiners to overlook possible application issues in an effort to expedite examination, which depending on the office, may have an effect on the presumption of validity of an allowed application.



**Justices Set to Rule on Test for  
Patent Indefiniteness**

**Paul M. Rivard**

***Banner & Witcoff Intellectual  
Property Alert***

**April 29, 2014**



## Intellectual Property Alert: Justices Set to Rule on Test for Patent Indefiniteness

By Paul M. Rivard

On April 28, 2014, the U.S. Supreme Court heard arguments in *Nautilus, Inc. v. Biosig Instruments, Inc.* involving the statutory requirement in 35 U.S.C. § 112, second paragraph for distinct patent claiming. The patent at issue relates to a heart rate monitor capable of measuring the heartbeat of an individual while exercising without attaching electrodes. The device compares electrical waves from an electrode gripped by the left hand to those from an electrode gripped by the right end in order to calculate the individual's heart rate.

Nautilus contended that the patent is indefinite based on a feature that common electrodes are placed in a "spaced relationship" to the live electrodes that record the signals. When an appropriate spacing is provided between the electrodes, interfering "noise" signals can be removed so that it is possible to determine heart rate. Nautilus urged that the patent's failure to define the particular magnitude of the spacing between the electrodes renders it fatally defective.

The district court agreed with Nautilus and ruled that the patent was invalid under 35 U.S.C. § 112, second paragraph. The district court explained that the term "spaced relationship" did not inform "what precisely the space should be" or "whether the spaced relationship on the left side should be the same as the spaced relationship on the right side."

The Federal Circuit reversed, concluding that "the claims provide inherent parameters sufficient for a skilled artisan to understand the bounds of 'spaced relationship.'" In addition, a skilled artisan could apply a test and determine the 'spaced relationship' as pertaining to the function of substantially removing EMG signals." The Federal Circuit reiterated its "insolubly ambiguous" standard under which claims should not be ruled indefinite as long as they are amenable to construction. Judge Schall concurred, agreeing that the claims are not indefinite but disagreeing that the "spaced relationship" is defined by the function of removing EMG signals.

The Supreme Court granted *certiorari* to consider the questions of (1) whether the Federal Circuit's acceptance of ambiguous patent claims with multiple reasonable interpretations – so long as the ambiguity is not "insoluble" by a court – defeats the statutory requirement of particular and distinct patent claiming; and (2) whether the presumption of validity dilutes the requirement of particular and distinct patent claiming.

Nautilus argued that whenever, after applying the tools of claim construction, a patent claim is subject to more than one reasonable construction, i.e., whenever it is ambiguous, it should be ruled indefinite. Nautilus argued that patent attorneys can easily draft claims which are not



ambiguous, but that economic incentives lead to the drafting of overly broad and ambiguous claims.

Several of the justices seemed troubled by this approach. Justice Sotomayor analogized claim construction to statutory construction and noted that judges frequently disagree over the meaning of statutory language. She was concerned that Nautilus' approach could present "a really big problem" by exposing nearly all patents to invalidation.

Justice Scalia asked whether guidance might be taken from the procedure used for courts to review agency action. Under the so-called *Chevron* rule, a reviewing court first determines whether there is more than one reasonable interpretation (i.e., ambiguity), and then looks at whether the agency's interpretation is reasonable. Nautilus suggested that a similar approach could be used for reviewing patent claims, except that whenever ambiguity is found the patent should be ruled indefinite.

Chief Justice Roberts questioned whether the standard proposed by the Solicitor General provided a better approach. Under this standard, "a patent satisfies the requirement if, in light of the specification and the prosecution history, a person skilled in the art would reasonably understand the scope of the claim." Nautilus agreed, provided that this meant there was "reasonable certainty" in the scope of the claim.

Counsel for Biosig argued the Federal Circuit correctly held that the claims were definite because their bounds were understood, and that the claims' functional language shed additional light on the "spaced relationship" limitation. Biosig also pointed to evidence that a person skilled in the art could make the invention in only a few hours after reading the patent, and argued that the patent law has long permitted some amount of experimentation.

Biosig urged that the Supreme Court's decision in *Markman* contemplated that there would be disputes between reasonable constructions of patent terms, and that patents should not be held invalid merely because there is more than one possible interpretation. Biosig agreed that a patent should be found invalid when there are two "equally plausible" constructions, but argued that indefiniteness should not be found if "the right answer is appreciably better than the second best answer."

The Court is expected to issue its ruling this June.

To subscribe or unsubscribe to this Intellectual Property Advisory, please send a message to Chris Hummel at [chummel@bannerwitcoff.com](mailto:chummel@bannerwitcoff.com)



[www.bannerwitcoff.com](http://www.bannerwitcoff.com)

© Copyright 2014 Banner & Witcoff, Ltd. All Rights Reserved. The opinions expressed in this publication are for the purpose of fostering productive discussions of legal issues and do not constitute the rendering of legal counseling or other professional services. No attorney-client relationship is created, nor is there any offer to provide legal services, by the publication and distribution of this edition of IP Alert.



**There's the Devil Federal Circuit  
Reiterates: No Room for Error in  
Priority Claims**

**Jordan N. Bodner and William E.  
Wooten**

**North Carolina Bar Association  
*IP Links***

**April 30, 2014**

## There's the Devil Federal Circuit Reiterates: No Room for Error in Priority Claims

Article Date: Wednesday, April 30, 2014

Written By: Jordan N. Bodner and William E. Wooten

**Introduction** | The late Chief Judge Giles S. Rich, in an oft-quoted précis of U.S. patent law, remarked that “the name of the game is the claim.” Giles S. Rich, “The Extent of the Protection and Interpretation of Claims — American Perspectives,” 21 *Int'l Rev. Indus. Prop. & Copyright L.*, 497, 499 (1990). The U.S. Court of Appeals for the Federal Circuit's recent decision in **Medtronic CoreValve, LLC v. Edwards Lifesciences Corp. (CoreValve)** serves as a reminder that the claims at the beginning of a patent can be just as important as those at the end.

In **CoreValve**, the Federal Circuit affirmed an invalidity determination, declined to adopt a proposed “reasonable person” test for interpreting the sufficiency of a priority claim, and reiterated that the burden of properly claiming priority rests squarely on the patentee. **CoreValve**, No. 2013-1117, slip op. at 12-13 (Fed. Cir. Jan. 22, 2014).

**The CoreValve Family** | At issue in **CoreValve** was Medtronic's U.S. Patent No. 7,892,281, entitled “Prosthetic Valve for Transluminal Delivery.” The '281 patent issued from U.S. Application Serial Number 12/348,892 (referred to in the opinion as “U.S. Application 10”). U.S. Application 10 and, in turn, the '281 patent, included two separate priority chains, only one of which was at issue in **CoreValve**. The priority chain at issue included a claim to U.S. Application Serial Number 12/029,031 (U.S. Application 8), U.S. Application Serial Number 11/352,614 (U.S. Application 6), U.S. Application Serial Number 10/412,634 (U.S. Application 4), and International Application Number PCT/FR 01/03258 (International Application 2b); International Application 2b claimed priority to French Application Number FR 00/14028 (French Application 1b). *Id.* at 3.

**The Gap** | U.S. Application 10 recited a priority chain that included claims to U.S. Applications 6 and 8, each of which included the following priority claim: “[T]his application is also a continuation-in-part of International Application No. PCT/FR 01/03258 [International Application 2b]. . . .” *Id.* at 9. The district court found that the phrase “this application” must mean “the present application” (i.e., U.S. Applications 6 and 8, respectively), and thus the priority claims in U.S. Applications 6 and 8 were defective as not expressly identifying U.S. Application 4 as the continuation-in-part. *Id.* at 10. The **CoreValve** panel deduced that Medtronic apparently “recycled the priority claim in [U.S. Application 4] for use in U.S. Applications 6 and 8.” *Id.*

**Game Changer** | Edwards contended that, due to the improper priority claims in intermediate U.S. Applications 6 and 8, the '281 patent should not be entitled to the benefit of French Application 1b and International Application 2b's filing dates, that patents issued from French Application 1b and International Application 2b constitute prior art under 35 U.S.C. section 102, and that their disclosures anticipate the claims of the '281 patent asserted by Medtronic. *See id.* at 6.

**Medtronic's Position** | Declining to contest the substance of Edwards' invalidity contentions, Medtronic focused on the priority date issue. Specifically, Medtronic argued: (1) “that the phrase ‘this application’ is not self-referential from application to application; rather, it always refers to U.S. Application 4, whether it is being used in U.S. Application 4, 6, or 8”; and (2) “that the meaning of the phrase ‘this application’ should not be rigidly determined, but instead should be based on what a reasonable person would understand it to disclose within the context.” *Id.* at 10-11.

**The Federal Circuit's Response** | Noting that Medtronic's priority date position hinged on a determination that the '281 patent's priority chain complied with the strictures of both 35 U.S.C. section 119 and 120, the **CoreValve** panel opted to address only the latter route—the one paved with precedent. *See id.* at 7 (“[W]e choose [section] 120”). The Federal Circuit explained that they had “recently clarified that the ‘specific reference’ requirement [of section 120] mandates ‘each [intermediate] application in the chain of priority to refer to the prior applications.’” *Id.* at 7-8 (quoting **Encyclopaedia Britannica, Inc. v. Alpine Elec. of Am., Inc.**, 609 F.3d 1345, 1352 (Fed. Cir. 2010)).

The panel concluded that, due to the failure of U.S. Applications 6 and 8 to “specifically reference the earlier filed applications in the priority chain, the '281 patent is not entitled to claim the priority date of International Application 2b under [section] 120.” **CoreValve**, slip op. at 8. Referring to the priority chain of U.S. Applications 6 and 8, the panel dryly noted that “[m]ore is required.” *Id.* at 9.

Citing the Manual of Patent Examining Procedure's instructions for claiming priority to an earlier filed application, as well as its own prior opinions' use of the phrase “this application,” the court dismissed “Medtronic's proposed meaning of ‘this application’ [as] an attempt at linguistic gymnastics [that] makes little sense relative to the straightforward, plain language meaning of the phrase.” *Id.* at 10 (citing M.P.E.P. § 201.11).

The court then declined to adopt Medtronic's proffered “reasonable person” approach for interpreting the disclosure of priority claims. *Id.* at 12. Emphasizing at the outset that Medtronic's “reasonable person” approach “runs afoul” of the section 120 requirement that a priority claim include “a specific reference” to each earlier filed application, the panel buttressed its stance by pointing out that the regulation implementing section 120 prescribes a level of detail that includes both the series code and serial number. *Id.* (citing 37 C.F.R. § 1.78(a)(2)(i)).

The court then shifted to the public policy underlying section 120's stringent requirements, concluding that Medtronic's “reasonable person” approach “improperly places the burden of deciphering a priority claim upon the reader or the public,” rather than the patentee, who is “best suited to understand the genealogy and relationship of her applications.” *Id.* at 13.

**The Increased Importance of an ADS** | Among the deluge of changes aimed at implementing the America Invents Act (AIA) is a requirement that priority claims be made in an application data sheet (ADS). *See* 37 C.F.R. §§ 1.55(d), 1.76(b)(5)-(6), and 1.78(a)(3). The requirement applies to U.S. non-provisional applications filed on or after Sept. 16, 2012, and Patent Cooperation Treaty (PCT) national stage applications with international filing dates on or after Sept. 16, 2012. The deadline for making priority claims remains unchanged. Priority claims must be made within four months of filing, or, if longer, within 16 months of the earliest priority date claimed. *See id.* §§ 1.55(d) and 1.78(a)(4).

**Conclusion** | Students of U.S. patent law should not be surprised to find the onus to draft proper priority claims placed squarely on the applicant's shoulders. Patent claims—the ones that come at the end—have long been construed against their authors. See, e.g., **Chef America, Inc. v. Lamb-Weston, Inc.**, 358 F.3d 1371, 1373 (Fed. Cir. 2004) (“It is the job of the patentee, and not the court, to write patents carefully and consistently.”). As the Federal Circuit's decision in **CoreValve** demonstrates, applicants and practitioners should carefully draft and review not only the claims found at the end of an application, but also those traditionally found at the beginning. Moreover, in light of the relatively recent requirement that priority claims be made in an ADS, practitioners would be well served to reconsider who within their organization is responsible for ensuring that ADSs are properly populated and reviewed.

As is so often the case: the devil is in the details. Or, as the late Chief Judge once quipped: “The life of a patent solicitor has always been a hard one.” **In re Ruschig**, 379 F.2d 990, 993 (C.C.P.A. 1967).

*Jordan N. Bodner and William E. Wooten are registered patent attorneys, active members of the North Carolina Bar and based in the Washington, D.C. office of Banner & Witcoff, Ltd.*

---

*Views and opinions expressed in articles published herein are the authors' only and are not to be attributed to this newsletter, the section, or the NCBA unless expressly stated. Authors are responsible for the accuracy of all citations and quotations.*



**U.S. Supreme Court Clarifies  
Definiteness Standard**

**Paul M. Rivard**

***Banner & Witcoff Intellectual  
Property Alert***

**June 3, 2014**



## Intellectual Property Alert: U.S. Supreme Court Clarifies Definiteness Standard

By Paul M. Rivard

June 3, 2014 —Yesterday, the U.S. Supreme Court issued its ruling in *Nautilus, Inc. v. Biosig Instruments, Inc.* involving the definiteness requirement of 35 U.S.C. § 112 (b). The patent at issue relates to a heart rate monitor capable of measuring the heartbeat of an individual while exercising without attaching electrodes. The device compares electrical waves from an electrode gripped by the left hand to those from an electrode gripped by the right hand in order to calculate the individual's heart rate.

At issue was a claim feature that common electrodes are placed in a “spaced relationship” to live electrodes, which record the signals. The district court construed the term to mean there is a “defined relationship” between the live and common electrodes on each side of the cylindrical bar. However, the district court granted a motion for summary judgment on indefiniteness because the term “spaced relationship” did not inform “what precisely the space should be” or “whether the spaced relationship on the left side should be the same as the spaced relationship on the right side.”

The Federal Circuit reversed, concluding that “the claims provide inherent parameters sufficient for a skilled artisan to understand the bounds of ‘spaced relationship,’” such as the fact that the distance separating the electrodes cannot be greater than the width of a user’s hand. The majority also pointed to the fact that “a skilled artisan could apply a test and determine the ‘spaced relationship’ as pertaining to the function of substantially removing EMG signals.” The Federal Circuit reiterated its “insolubly ambiguous” standard under which claims should not be ruled indefinite as long as they are amenable to construction. Judge Schall concurred, agreeing that the claims are not indefinite but disagreeing that the “spaced relationship” is defined by the function of removing EMG signals.

In a unanimous decision delivered by Justice Ginsburg, the Supreme Court rejected the Federal Circuit’s articulation of the definiteness standard, which it said “tolerates some ambiguous claims but not others.” The High Court ruled that “[i]n place of the ‘insolubly ambiguous’ standard, we hold that a patent is invalid for indefiniteness if its claims, read in light of the specification delineating the patent, and the prosecution history, fail to inform, with reasonable certainty, those skilled in the art about the scope of the invention.”

The Court emphasized the patent law’s competing concerns between encouraging innovation and providing adequate public notice of patent rights. The Court said that the newly announced

“reasonable certainty” standard strikes an appropriate balance between these concerns by “mandat[ing] clarity, while recognizing that absolute precision is unattainable.”

Although the Court disagreed with the Federal Circuit’s articulation of the appropriate test for indefiniteness, it did not address the underlying question of whether the claims at issue are definite. The case was remanded to the Federal Circuit to consider this question in light of the Court’s decision.

To subscribe or unsubscribe to this Intellectual Property Advisory,  
please send a message to Chris Hummel at [chummel@bannerwitcoff.com](mailto:chummel@bannerwitcoff.com).



[www.bannerwitcoff.com](http://www.bannerwitcoff.com)

© Copyright 2014 Banner & Witcoff, Ltd. All Rights Reserved. The opinions expressed in this publication are for the purpose of fostering productive discussions of legal issues and do not constitute the rendering of legal counseling or other professional services. No attorney-client relationship is created, nor is there any offer to provide legal services, by the publication and distribution of this edition of IP Alert.



**Computer-Implemented Inventions:  
Ideas That Are Fundamental Truths  
and Generically Implemented Are  
Not Patent Eligible**

**Charles W. Shifley**

***Banner & Witcoff Intellectual  
Property Alert***

**June 20, 2014**





## Intellectual Property Alert: Computer-Implemented Inventions: Ideas That Are Fundamental Truths And Generically Implemented Are Not Patent Eligible

By Charles W. Shifley

June 20, 2014 — In a unanimous opinion authored by Justice Thomas on June 19, 2014, the Court held in *Alice Corp. v. CLS Bank Int'l*, 13-298, that all the patent claims in the case, meaning all method, system and “computer-readable medium” claims, were not patent eligible.

While unanimous, the details of the opinion will nevertheless likely be debated hotly and without foreseeable end by IP professors, commentators, and practitioners, just as will be the whole of the subject of patent eligibility for computer-implemented inventions. Debate will continue in that essentially nothing new was added by the opinion to the subject’s jurisprudence, and provocative ambiguities were expressly placed in the opinion.

While three Justices in concurrence would have decided the case on the principle that no business method patents should exist whatsoever, their principle was not implemented by the whole of the Court. The Court’s test of eligibility, in contrast, is more nuanced blocking patents on fundamental, long-existing practices of human activity, implemented generically on computers, but leaving other practices and implementations open to the possibility of patenting. The question of whether an improvement in computer functioning, or an improvement in non-computer technology or a technical field, will be required for a computer-implemented invention will be a central focus of the foreseeably unending debate.

### Petitioner’s weakness eases Court’s decision

In *Alice*, the petitioner was a patent owner whose invention was found not patent eligible by the district court and Federal Circuit. It sought to convince the Supreme Court about the patentability of its process and system claims to intermediated settlements in trading situations. It lost. The Federal Circuit was affirmed.

Major reasons for the patent owner’s loss are revealed by the weaknesses of the owner’s case. The owner/petitioner’s brief conceded that its patent claims described intermediated settlement. Slip op. at 9. At oral argument, given opportunity, the petitioner was unable to articulate anything that distinguished the inventions from intermediated settlements in the abstract. Oral argument further included the concession that with the idea of the patent in hand, a second-year college class in engineering could program the idea over the weekend at a Silicon Valley coffee shop. (This is not an exaggeration; this was the actual concession, down to the engineering class, weekend, and coffee shop.)

Unfortunate for others was the ease of decision that the petitioner's weaknesses provided the Court. Rather than be required to state how the public could determine whether the idea of an invention was abstract, the Court could shirk that it "need not labor to delimit the precise contours of the 'abstract ideas' category." Slip op. at 10. It only had to inform the petitioner that the abstract ideas category was not limited to principles that existed apart from human action. Slip op. at 10.

Rather than be required to confront specifics of sophisticated computer programming, the Court could state that the patent claims at issue involved only "generic computer implementation." Slip op. at 10. Put in other words, "each step [of the claims] does no more than require a generic computer to perform generic computer functions." Slip op. at 15. Put somewhat more carefully, the Court could state that the method claims involved only electronic recordkeeping, obtaining data, adjusting account balances, and automated instructions, while the system claims involved only a data processing system, a communications controller, and a data storage unit. Slip op. at 15-16.

#### Court waffles with abstract ideas and required inventive concept

Unfortunately for the public and practitioners, the Court shifted between broad and narrow articulations of the abstract ideas category, and broad and narrow articulations of what additions to an abstract idea an "inventive concept," may entitle a patent claim to eligibility.

In describing what constitutes an abstract idea, the Court in places stated broadly that an idea fits the abstract ideas category if the idea is a "building block of human ingenuity." E.g., slip op. at 6. Elsewhere, it articulated more specifically that an idea might only be abstract if it covered a fundamental practice long prevalent in one of the public's systems of activities, such as its system of commerce. Slip op. at 9.

With respect to additions to an abstract idea that may entitle the idea to be eligible for patent, the Court stated broadly that only an inventive concept was necessary. Slip op. at 12. The concept could be any element or combination of elements sufficient to ensure the patent amounts to significantly more than a patent on the abstract idea itself. Slip op. at 7. But elsewhere, it articulated that an improvement to the functioning of a computer was possibly necessary, or an improvement in a non-computer technology or technical field. Slip op. at 15.

Given the ambiguities of the opinion in its shifting articulations of the tests for the abstractness of ideas and the inventiveness of inventive concepts, patent owners in future disputes can be imagined to potentially argue that the ideas of their patents are not fundamental to the overarching system such as commerce within which they exist, but only one of many available and alternative practices within the system. They might also argue that their ideas were not long prevalent in the system, but instead, in their full conception down to their details, conceived and brought into existence first by their alleged inventors. Forced to concede the existence of abstract ideas, patent owners might alternatively argue that the additions to the ideas in the claims, whatever the additions are, other than generic computer implementations, are sufficient to ensure that the patents involved are more than patents on the abstract ideas themselves.

In contrast, accused infringers can be imagined arguing that the ideas of asserted patents are building blocks of human ingenuity, even where they are smaller blocks — because no size of block was stated in *Alice*. Accused infringers can also be imagined to argue as if a specific form of an idea was instead the idea itself, especially in their labeling of the idea. Accused infringers can also easily be imagined arguing that patents having abstract ideas are not eligible for the patenting they received because they do not include improvement to the functioning of computers or improvements in a non-computer technology or technical field.

#### Decision fails to provide solution

Given the lack of labor of the opinion in delimiting the contours of the abstract ideas category, patent professors and commentators are predicted to continue their outcry that no one knows what an abstract idea is. Because apart from the ideas of *Bilski*, hedging financial risk, and *Alice*, intermediated settlement, and apart from the formulas of *Benson*, *Flook*, and *Diehr*, they are right, we don't.

And given the heavy emphasis on the need for an inventive concept, the same professors and commentators will start a cry that no one knows what an inventive concept is. And again, apart from generic computer implementation by electronic recordkeeping, obtaining data, adjusting account balances, and automated instructions, through data processing systems, communications controller, and data storage units, we don't.

What we do know, giving *Alice* an evenhanded interpretation, is only that patents on ideas that cannot be distinguished from fundamental truths long prevalent in human systems, such as commerce, which are only generically computer implemented, are not eligible for patents.

To subscribe or unsubscribe to this Intellectual Property Advisory,  
please send a message to Chris Hummel at [chummel@bannerwitcoff.com](mailto:chummel@bannerwitcoff.com)



[www.bannerwitcoff.com](http://www.bannerwitcoff.com)

© Copyright 2014 Banner & Witcoff, Ltd. All Rights Reserved. The opinions expressed in this publication are for the purpose of fostering productive discussions of legal issues and do not constitute the rendering of legal counseling or other professional services. No attorney-client relationship is created, nor is there any offer to provide legal services, by the publication and distribution of this edition of IP Alert.



**Three Rounds to Knock Out  
Ultramercial's Patent on  
"Advertising as Currency"**

**Shawn P. Gorman and Aseet Patel**

***Banner & Witcoff Intellectual  
Property Alert***

**November 21, 2014**



## Intellectual Property Alert: Three Rounds to Knock Out Ultramercial’s Patent on “Advertising as Currency”

By [Shawn P. Gorman](#) and [Aseet Patel](#)

Nov. 21, 2014 — After sparring three separate rounds at the Court of Appeals for the Federal Circuit, in a panel opinion authored by Judge Lourie, the Federal Circuit affirmed the district court’s grant of Defendant WildTangent’s pre-answer Fed. R. Civ. P. 12(b)(6) motion to dismiss the suit for failure to claim patent eligible subject matter. *See Ultramercial, Inc. v. Hulu, LLC*, No. 2010-1544, slip op. at 3 (Fed. Cir. Nov. 14, 2014) [hereinafter *Ultramercial III*]. The Court held all claims of Ultramercial’s U.S. Patent No. 7,346,545 (the ’545 patent) invalid under 35 U.S.C. § 101 as patent ineligible. The Court’s scrutiny primarily focused on the method recited as claim 1, however, the Court reasoned that “[a]s the other claims of the [’545] patent are drawn to a similar process [as claim 1], they suffer from the same infirmity as claim 1 and need not be considered further.” *Id.* at 5. Claim 1 recites:

A method for distribution of products over the Internet via a facilitator, said method comprising the steps of:

a first step of receiving, from a content provider, media products that are covered by intellectual-property rights protection and are available for purchase, wherein each said media product being comprised of at least one of text data, music data, and video data;

a second step of selecting a sponsor message to be associated with the media product, said sponsor message being selected from a plurality of sponsor messages, said second step including accessing an activity log to verify that the total number of times which the sponsor message has been previously presented is less than the number of transaction cycles contracted by the sponsor of the sponsor message;

a third step of providing the media product for sale at an Internet website;

a fourth step of restricting general public access to said media product;

a fifth step of offering to a consumer access to the media product without charge to the consumer on the precondition that the consumer views the sponsor message;

a sixth step of receiving from the consumer a request to view the sponsor message, wherein the consumer submits said request in response to being offered access to the media product;

a seventh step of, in response to receiving the request from the consumer, facilitating the display of a sponsor message to the consumer;

an eighth step of, if the sponsor message is not an interactive message, allowing said consumer access to said media product after said step of facilitating the display of said sponsor message;

a ninth step of, if the sponsor message is an interactive message, presenting at least one query to the consumer and allowing said consumer access to said media product after receiving a response to said at least one query;

a tenth step of recording the transaction event to the activity log, said tenth step including updating the total number of times the sponsor message has been presented; and

an eleventh step of receiving payment from the sponsor of the sponsor message displayed.

The Court’s legal reasoning for the holding of invalidity followed a pattern similar to many of their recent decisions involving the issue of patent eligibility. *See buySAFE, Inc. v. Google, Inc.*, 765 F.3d 1350 (Fed. Cir. 2014); *I/P Engine, Inc. v. AOL, Inc.*, Nos. 2013-1307, -1313, 2014 WL 3973501 (Fed. Cir. Aug. 15, 2014); *Digitech Image Techs., LLC v. Elecs. for Imaging, Inc.*, 758 F.3d 1344 (Fed. Cir. 2014). The Court recapitulated the framework set out in *Alice Corp. v. CLS Bank Int’l* as follows:

A § 101 analysis begins by identifying whether an invention fits within one of the four statutorily provided categories of patent-eligible subject matter: processes, machines, manufactures, and compositions of matter. 35 U.S.C. § 101. . . . “First, we determine whether the claims at issue are directed to one of those patent-ineligible concepts.” . . . Then, in the second step, if we determine that the claims at issue are directed to one of those patent-ineligible concepts, we must determine whether the claims contain “an element or combination of elements that is ‘sufficient to ensure that the patent in practice amounts to significantly more than a patent upon the [ineligible concept] itself.’”

*Ulramercial III*, slip op. at 7–8 (citations omitted) (alteration in original) (characterizing *Alice Corp. v. CLS Bank Int’l*, 134 S. Ct. 2347 (2014)).

Under the two-part § 101 analysis, the Court first examined method claim 1 of the ’545 patent to assess whether it recited an abstract idea. The Court found that although claim 1 recites an “ordered combination of [eleven] steps, [it] recites an abstraction—an idea, having no particular concrete or tangible form.” *Id.* at 9. The Court reasoned that “[a]lthough certain additional limitations, such as consulting an activity log [as recited in the second step of claim 1], add a degree of particularity, the concept embodied by the majority of the limitations describes only the abstract idea of showing an advertisement before delivering free content.” *Id.* at 9–10 (emphasis added). Moreover, the Court noted that the inclusion of merely novel or non-routine components, which *Ulramercial* vehemently argued are recited in claim 1 of the ’545 patent, do not necessarily turn an abstraction into something concrete. *Id.* at 10; *see Supplemental Brief of Plaintiffs-Appellants, Ulramercial, Inc. v. Hulu, LLC*, No. 2010-1544 (Fed. Cir. Aug. 27, 2014), 2014 WL 4402271, at \*5-7. The Court stressed this point by elaborating on the distinctiveness of the first step of the two-part analysis, stating that: “any novelty in implementation of the idea is a

factor to be considered only in the second step of the *Alice* analysis.” *Ultramercial III*, slip op. at 10.

Nevertheless, in the second step of the two-part § 101 analysis, the Court was still unpersuaded by Ultramercial’s arguments about the novelty of its method steps. The Court reasoned “[t]hat some of the eleven steps were not previously employed in this art is not enough—standing alone—to confer patent eligibility upon the claims at issue.” *Id.* at 12. “None of these eleven individual steps, viewed ‘both individually and as an ordered combination,’ transform the nature of the claim into patent-eligible subject matter.” *Id.* at 11 (quoting *Alice Corp.*, 134 S. Ct. at 2355). The Court continued: “The majority of those steps comprise the abstract concept of offering media content in exchange for viewing an advertisement.” *Id.* (emphasis added). “Adding routine additional steps such as updating an activity log, requiring a request from the consumer to view the ad, restrictions on public access, and use of the Internet does not transform an otherwise abstract idea into patent-eligible subject matter. Instead, the claimed sequence of steps comprises only ‘conventional steps, specified at a high level of generality,’ which is insufficient to supply an ‘inventive concept.’” *Id.* at 11 (quoting *Alice*, 134 S. Ct. at 2357). In particular, the Court noted that “the use of the Internet is not sufficient to save otherwise abstract claims from ineligibility under § 101.” *Id.* (citing *CyberSource Corp. v. Retail Decisions, Inc.*, 654 F.3d 1366, 1370 (Fed. Cir. 2011) (reasoning that the use of the Internet to verify credit card transaction does not meaningfully add to the abstract idea of verifying the transaction)).

In addition, the Court scrutinized the claims under the machine-or-transformation test, which *Bilski v. Kappos* stated can provide a “useful clue” in the second step of the two-part § 101 analysis. *See Bilski v. Kappos*, 561 U.S. 593, 604 (2010). Even under the machine-or-transformation test, the Court arrived at the same conclusion—that the claims are directed towards patent ineligible subject matter. “Any transformation from the use of computers or the transfer of content between computers is merely what computers do and does not change the analysis.” *Ultramercial III*, slip op. at 13. Regarding the machine prong of the machine-or-transformation test, the Court explained that the recitation of a “facilitator” in the preamble of claim 1 did not tie the claims to a novel machine, because “the specification [of the ’545 patent] makes clear that the facilitator can be a person and not a machine.” *Id.* Regarding the transformation prong of the test, the Court concluded that “[t]hese manipulations of ‘public or private legal obligations or relationships, business risks, or other such abstractions cannot meet the test because they are not physical objects or substances, and they are not representative of physical objects or substances.’” *Id.* (quoting *In re Bilski*, 545 F.3d 943, 963 (Fed. Cir. 2008) (en banc), *aff’d on other grounds*, *Bilski*, 561 U.S. 593).

### **Concurring Opinion – Judge Mayer**

Spanning 12 pages, Judge Mayer’s concurring opinion was almost as long as the 14-page panel opinion. In the concurring opinion, Judge Mayer reiterated some of the same positions as in his previous concurring opinion in *I/P Engine, Inc. v. AOL, Inc.*, Nos. 2013-1307, -1313, 2014 WL 3973501 (Fed. Cir. Aug. 15, 2014) (Mayer, J., concurring). Judge Mayer emphasized three main points regarding his views on 35 U.S.C. § 101 and enforcement of patent-eligible subject matter under the Court’s guidance set forth in *Alice*.

“First, whether claims meet the demands of 35 U.S.C. § 101 is a threshold question, one that must be addressed at the outset of litigation.” *Ultramercial III*, slip op. at 1 (Mayer, J., concurring) (emphasis added). Section 101 “is the sentinel, charged with the duty of ensuring that our nation’s patent laws encourage, rather than impede, scientific progress and technological innovation.” *Id.* at 2. Judge Mayer’s strong language, albeit in a concurring opinion, will likely provide fodder for litigators in the decision over whether or not to pursue a Rule 12(b)(6) motion to dismiss, much in the same way that WildTangent did in this case.

Second, despite the Patent Act indicating that issued patents shall be “presumed valid,” Judge Mayer stated that: “no presumption of eligibility attends the section 101 inquiry.” 35 U.S.C. § 282; *Id.* at 1. Judge Mayer explained: “Because the PTO has for many years applied an insufficiently rigorous subject matter eligibility standard, no presumption of eligibility should attach when assessing whether claims meet the demands of section 101.” *Id.* at 6–7.

“Third, *Alice Corporation v. CLS Bank International*, for all intents and purposes, set out a technological arts test for patent eligibility.” *Id.* at 1. Judge Mayer went on to explain that “*Alice* recognized that the patent system does not extend to all products of human ingenuity. Because the system’s objective is to encourage ‘the onward march of science,’ its rewards do not flow to ideas—even good ones—outside of the technological arena.” *Id.* at 7–8; *see also Myriad*, 133 S. Ct. at 2117 (“Groundbreaking, innovative, or even brilliant discovery does not by itself satisfy the § 101 inquiry.”). “In assessing patent eligibility, advances in non-technological disciplines—such as business, law, or the social sciences—simply do not count.” *Id.* at 8. Judge Mayer further elaborated that “[i]t is not that generic computers and the Internet are not ‘technology,’ but instead that they have become indispensable staples of contemporary life. Because they are the basic tools of modern-day commercial and social interaction, their use should in general remain ‘free to all men and reserved exclusively to none.’” *Id.* at 11 (quoting *Funk Bros. Seed Co. v. Kalo Inoculant Co.*, 333 U.S. 127, 130 (1948)).

The concurring opinion admitted that the Supreme Court “declined to hold ‘that business methods are categorically outside of § 101’s scope.’ Notably, however, [the Supreme Court] invited [the Federal Circuit] to fashion a rule defining a ‘narrower category’ of patent-ineligible claims directed to methods of conducting business.” *Id.* at 9. Judge Mayer appears to believe that his proposed rule “holding that claims are impermissibly abstract if they are directed to an entrepreneurial objective, such as methods for increasing revenue, minimizing economic risk, or structuring commercial transactions, rather than a technological one, would comport with the guidance provided in both *Alice* and *Bilski*.” *Id.*

## **Conclusion**

*Ultramercial III* held that claim 1 of the ’545 patent was patent ineligible as directed to an abstract idea and applied the same rationale to the remaining claims. Given that the Supreme Court previously admonished the Federal Circuit for formulating bright-line rules, it is not surprising that the Court did not proffer a definition of “abstract idea;” instead, the Court provided a benchmark, noting that the ’545 patent failed to claim “significantly more” than simply the abstract idea. Nevertheless, the Court did acknowledge that it did “not purport to state



that all claims in all software-based patents will necessarily be directed to an abstract idea. Future cases may turn out differently.” *Ultramercial III*, slip op. at 10.

Going forward, perhaps the Court’s repeated references to a “majority” of the 11 steps recited in claim 1 of the ’545 patent may suggest a new best practice for patent practitioners drafting new patent applications and prosecuting existing applications, particularly in the business method and software arts. Further, in the wake of *Alice*, some of the suggestions raised by practitioners and judges, have sometimes seemed counter-intuitive, but may help lead to a path to finding patent eligible subject matter under the *Alice* framework. See, e.g., *McRO, Inc., v. Capcom, Inc.*, No. 12-10337, 2014 WL 4758745, at \*8 (C.D. Cal. Sept. 22, 2014) (“Section 101 motions can place parties in unfamiliar and uncomfortable positions: here it is to the patentee’s advantage to identify noninfringing alternatives...; the reverse of their positions at the infringement and damages stages of the case.”).

Finally, *Ultramercial III* is also telling for what is *not* stated in the opinion, almost as much as what is expressly stated. For example, Judge Lourie—who authored the Court’s opinion, and also sat on the panels of *Ultramercial I* and *Ultramercial II*—did not reconcile the Court’s decision with the previous legal reasoning and analysis confirming the ’545 patent as claiming patent-eligible subject matter. See *Ultramercial, LLC v. Hulu, LLC*, 657 F.3d 1323 (Fed. Cir. 2011) [*Ultramercial I*]; *Ultramercial, LLC v. Hulu, LLC*, 722 F.3d 1335 (Fed. Cir. 2013) [*Ultramercial II*]. A juxtaposition of the analysis and reasoning in *Ultramercial I* and *Ultramercial II* against the reasoning in *Ultramercial III* may be revealing of the changing landscape.

Click [here](#) to download the decision in *Ultramercial III*.

To subscribe or unsubscribe to this Intellectual Property Advisory, please send a message to Chris Hummel at [chummel@bannerwitcoff.com](mailto:chummel@bannerwitcoff.com)



[www.bannerwitcoff.com](http://www.bannerwitcoff.com)

© Copyright 2014 Banner & Witcoff, Ltd. All Rights Reserved. The opinions expressed in this publication are for the purpose of fostering productive discussions of legal issues and do not constitute the rendering of legal counseling or other professional services. No attorney-client relationship is created, nor is there any offer to provide legal services, by the publication and distribution of this edition of IP Alert.

**SUPREME COURT**

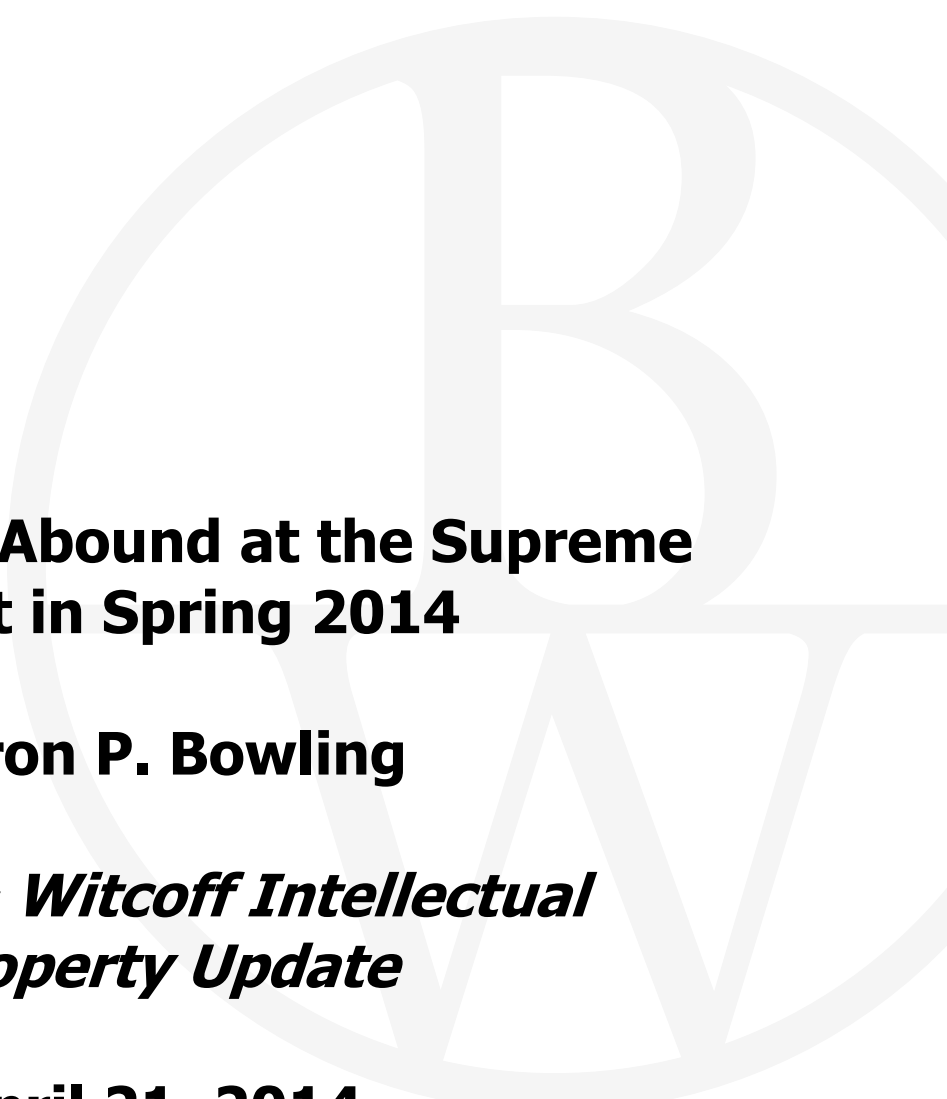

**IP Decisions Abound at the Supreme  
Court in Spring 2014**

**Aaron P. Bowling**

***Banner & Witcoff Intellectual  
Property Update***

**April 21, 2014**

## IP DECISIONS AROUND AT THE SUPREME COURT IN SPRING 2014



BY: AARON BOWLING

After leaving the realm of intellectual property law alone for decades, and allowing the Federal Circuit 25 years of mostly undisturbed jurisprudence, the United States Supreme Court has strongly reestablished its presence over the past eight years. This year especially, the Court will hear a wide array of patent, trademark and copyright cases, setting the stage for 2014 to be a banner year for Supreme Court IP decisions. Now, more than ever, successful and effective IP practice will require close observance of the high court's activity. To help, a synopsis follows of each case decided, or to-be-decided, in 2014.

### CAN LACHES BE APPLIED WHEN PLAINTIFF IS WITHIN THE STATUTE OF LIMITATIONS?

On January 21, the Supreme Court heard oral arguments in *Petrella v. MGM*, a copyright infringement action involving 1980 boxing movie, "Raging Bull." In its forthcoming opinion, the Supreme Court will address the applicability of laches to copyright infringement claims brought within the statute of limitations.

Laches is an equitable defense that bars a plaintiff's unreasonably delayed claims. In *Petrella*, the daughter and heir of screenwriter Frank Petrella sued Metro-Goldwyn-Mayer Studios (MGM) in 2009, alleging that the "Raging Bull" film constituted an unauthorized exploitation of Petrella's derivative rights.

Although Petrella was asserting her rights nearly 30 years after MGM released the film, she sought damages only for acts of infringement occurring within the three-year statute of limitations set forth in the Copyright Act, i.e., from 2006 to the filing of her complaint.

Nonetheless, the Central District of California, and subsequently the Ninth Circuit, held that Petrella's claim was barred by laches. Both courts agreed that Petrella's delay was unreasonable, and that the delay prejudiced the defendants, both from a commercial and evidentiary standpoint.

At oral arguments in January, the Justices actively debated Congress' intended purpose for the three-year statute of limitations provision, and whether Congress' purpose was distinct from the underlying policy objectives of laches. Furthermore, the Court considered, if laches and the statute of limitations can in fact coexist, should laches bar the plaintiff from obtaining injunctive relief, damages or both?

The high court appeared divided, reflecting a stark division that currently exists among federal appellate courts: the Fourth Circuit completely bars defendants from asserting laches within the statute of limitations; the Eleventh Circuit allows laches during the statutory period only for retrospective (not prospective) relief; the Second Circuit allows laches only for equitable (not legal) relief; and the Ninth Circuit allows laches without restriction.

The decision, expected in June, is highly anticipated amongst copyright owners, particularly those in the film and music industries, where copyright owners often assert their rights years after the alleged infringement.

### PATENTEES ALWAYS BEAR BURDEN OF PROVING INFRINGEMENT

On January 22, the Supreme Court began its year by unanimously reversing the Federal Circuit in *Medtronic v. Mirowski Family Ventures*. The high court held that the burden of proving infringement remains on the patent owner, even when a licensee seeks a declaratory judgment of noninfringement. The decision, authored by

Justice Stephen Breyer, substantially benefits patent licensees, who, upon showing declaratory standing, may now force the licensor to prove that a licensed patent covers the licensee's products, and do so at a time and forum of the licensee's choosing.

As a general rule, the patentee always carries the burden of proving infringement; but at the case below, the Federal Circuit carved out an exception in the limited circumstances where a licensee files declaratory judgment against its licensor. In those cases, the three-judge panel held, the *licensee* must prove *noninfringement*, rather than the patentee proving infringement.

The Supreme Court quickly rejected the Federal Circuit's burden shift, first taking a statutory approach and pointing out that the Declaratory Judgment Act has only procedural, not substantive, impact. The burden of proof is a substantive matter, and a burden shift a substantive change, and thus, the burden shift was legal error.

The Court also rejected the Federal Circuit on policy grounds, opining that the new exception would cause post-litigation uncertainty about the scope of the litigated patent. If the declaratory judgment had a different burden than its corresponding coercive action, the Court explained, the declaratory judgment action would have no claim preclusive effect over the later action. Instead, the parties would be forced to relitigate the entire infringement allegation, and the declaratory judgment action would fail to achieve its intended purpose of providing an "immediate and definitive determination of the legal rights of the parties."

The respondents expressed concerns that, without the Federal Circuit's exception, licensees could easily "force the patentee into full-blown patent infringement litigation . . . at [their] sole discretion." The Court countered

that those circumstances are strictly limited to situations where the licensee can show a genuine dispute of "sufficient immediacy and reality" about the patent's validity or its application. Overall, the Court concluded, the "general public interest considerations are, at most, in balance . . . and do not favor a change in the ordinary rule imposing the burden of proving infringement upon the patentee."

### CHANGES TO THE STANDARD FOR ATTORNEYS' FEES AWARDS IN PATENT CASES APPEAR IMMINENT

On February 26, the Supreme Court heard oral arguments in two cases, *Octane Fitness v. Icon Health & Fitness* and *Highmark v. Allcare Health Management*, both directed to the standard for determining when an award of attorneys' fees is appropriate. Under 35 U.S.C. § 285, courts should award attorneys' fees only in "exceptional" cases. The Federal Circuit finds a case is "exceptional" only when "both (1) the litigation is brought in subjective bad faith, and (2) the litigation is objectively baseless."

In *Octane*, the district court granted summary judgment of noninfringement in favor of alleged infringer Octane, but denied Octane's request for attorneys' fees, finding that plaintiff's case was neither objectively baseless nor brought in bad faith. After the Federal Circuit affirmed, Octane petitioned the Supreme Court, asserting that the Federal Circuit's "rigid" test for awarding fees "improperly appropriates a district court's discretionary authority" and "raises the standard for accused infringers (but not patentees) to recoup fees." As a result, Octane argued, patent plaintiffs are encouraged to bring "spurious patent cases" to cause competitive harm or coerce unwarranted settlement from defendants.

In *Highmark*, defendant Highmark also prevailed at district court by defeating a claim of infringement, but the Federal Circuit

Overall, the Court concluded, the "general public interest considerations are, at most, in balance . . . and do not favor a change in the ordinary rule imposing the burden of proving infringement upon the patentee."

MORE➤

reversed in part the district court's award of attorneys' fees. In its petition, Highmark asked the Supreme Court to address the level of deference that appellate courts give to fee award determinations. As the law stands, the Federal Circuit uses three distinct standards of review for the various aspects of its "exceptional" test. The "objectively baseless" prong receives *de novo* review; the "subjective bad-faith" prong is reviewed for clear error; and if the case is deemed exceptional, the awarding of fees is reviewed under an abuse of discretion standard.

At oral argument, the Court appeared to favor both petitioners. Regarding *Octane*, the majority of justices seemed convinced that district courts require more discretion in deciding whether to award attorneys' fees in accordance with § 285. A revised standard may instruct district courts to consider the totality of the circumstances and determine if the failure to shift fees would result in a "gross injustice." Regarding *Highmark*, the majority of justices appeared to agree that appellate courts need to provide more discretion to district court fee awards, for example, by utilizing an abuse of discretion standard.

If the Supreme Court's ruling falls along these lines, practitioners can expect district courts to issue attorneys' fees to alleged infringers more readily, and can expect appellate courts to more rarely overturn those awards on appeal.

### ARE COMPUTER-IMPLEMENTED SOFTWARE METHODS PATENT ELIGIBLE?

On March 31, the Supreme Court heard arguments in *Alice Corp. v. CLS Bank International* on whether claims to computer-implemented process or system inventions are ineligible for patent protection under 35 U.S.C. § 101 as being directed to abstract ideas.

Alice's patents relate to a computerized trading platform used for conducting financial transactions. Under the claimed invention,

a third party "settles" (oversees and ensures) obligations between a first and second party so as to eliminate the risk that one party will perform while the other will not.

CLS allegedly began infringing the Alice patents in 2002. After licensing negotiations failed, CLS filed declaratory judgment in the District Court of D.C., asserting invalidity and noninfringement. The District Court granted summary judgment of invalidity, holding that Alice's patents constituted patent ineligible abstract ideas under § 101.

The district court explained that the method "of employing an intermediary to facilitate simultaneous exchange of obligations in order to minimize risk" is a "basic business or financial concept." Thus, the court continued, a "computer system merely 'configured' to implement an abstract method, is no more patentable than an abstract method that is simply 'electronically' implemented."

At the Federal Circuit, a three-judge panel reversed the district court, holding that computer-implemented inventions like Alice's are *eligible* under § 101 unless it is "manifestly evident" that the claims are about an abstract idea. To be "manifestly evident," the "single most reasonable understanding" must be "that a claim is directed to nothing more than a fundamental truth or disembodied concept, with no limitations in the claim attaching that idea to a specific application."

CLS petitioned for rehearing *en banc*, and after granting the petition, the Federal Circuit vacated the earlier panel opinion, reinstated the district court's holding and ultimately issued six separate opinions spanning more than 125 pages. The Court split 5-5 with respect to the eligibility of Alice's computer system claims and failed to offer a majority-endorsed approach for determining whether a computer-implemented invention is a patent-ineligible, abstract idea.

In urging the Supreme Court to grant its cert petition, Alice pointed to the Federal Circuit's "inability to make a decision" and the apparent "enormous confusion that exists" as evidence that prompt intervention is necessary.

The level of interest in *Alice v. CLS Bank* among those in the software industry is enormous. The Supreme Court received 51 amicus briefs, including those filed by technology giants Google and Microsoft, and an amicus co-authored by Banner & Witcoff's Charles W. Shifley on behalf of the Intellectual Property Law Association of Chicago.

At oral argument on March 31, the Justices struggled to gain clarity and consensus on what benefits, if any, the proposed changes to software patent eligibility may provide. Justice Stephen Breyer, the most active member of the bench, likened the Court's predicament to being "between Scylla and Charybdis." Like Odysseus navigated a strait between the two monsters, the Supreme Court endeavored to define patent eligibility so as to allow the patenting of "real inventions with computers," yet prevent the patenting of abstract ideas.

In its forthcoming opinion, expected by the end of June, the Supreme Court may chart new waters and rule broadly on the patent eligibility of software-based patents, or it may instead rule narrowly, affirming the Alice invention as ineligible for patent, and confronting the issue of software eligibility another day.

### THE LANHAM ACT AND FALSE ADVERTISING OF FOOD PRODUCTS

In *POM Wonderful v. Coca Cola*, the Supreme Court will address the interplay between the false advertising provisions of the Lanham Act and the Food, Drug & Cosmetics Act (FDCA). In 2008, POM sued Coke under the Lanham Act and California state false advertising laws, alleging that Coke misled consumers into believing that Coke's Pomegranate Blueberry product contained predominantly pomegranate and blueberry juice.

Lanham Act § 1125(a) broadly prohibits false advertising, authorizing suit against those who use a false or misleading description or representation "in connection with any goods." Any person "who believes that he or she is or is likely to be damaged by" the use of that false description or representation may bring suit. Likewise, the FDCA provides that a food is misbranded if "its labeling is false or misleading in any particular," or "[i]f any word, statement, or other information required by" the FDCA or its regulations "to appear on the label or labeling is not prominently placed thereon with such conspicuousness . . . and in such terms as to render it likely to be read and understood by the ordinary individual under customary conditions of purchase and use."

Coke's Pomegranate Blueberry juice beverage contains 0.3 percent pomegranate juice and 0.2 percent blueberry juice in a fruit juice blend that contains 99.4 percent apple and grape juice. Food and Drug Administration (FDA) regulations, however, allow juice producers to describe their product using the names of juices that are used in only very small volumes as flavoring. Thus, even if POM's assertions of false advertising were true, Coke was nonetheless in compliance with FDA regulations.

With that conflict in mind, the Central District of California held that the FDCA barred POM's Lanham Act claim against the name and labeling of Coke's product and expressly preempted POM's state law claims. The Ninth Circuit affirmed, pointing to FDCA's 337(a), which requires that "all such proceedings for the enforcement, or to restrain violations, of [the FDCA] shall be by and in the name of the United States." The Ninth Circuit held that the FDA "comprehensively regulates food and beverage labeling," and "for a court to act when the FDA has not — despite regulating extensively in this area — would risk undercutting the FDA's expert judgments and authority." To "give effect to Congress' will,"

**MORE**➤

the Ninth Circuit furthered, “we must respect the FDA’s apparent decision not to impose the requirements urged by POM.”

After hearing arguments on April 21, the Supreme Court’s holding may go in a number of directions: it may bar all private claims under the FDCA, it may bar Lanham Act claims directed to products regulated by the FDCA, or it may reverse the Ninth Circuit and allow private claims against food companies.

### ARE STREAMING INTERNET TELEVISION BROADCASTS “PUBLIC PERFORMANCES?”

In *American Broadcasting Companies v. Aereo*, the Supreme Court will decide whether a company “publicly performs” a copyrighted television program when it retransmits a broadcast of that program to paid subscribers over the Internet.

Under the federal Copyright Act, the owners of protected creations have an exclusive right “to perform the copyrighted work publicly.” Aereo, a two-year-old company based in New York, captures over-the-air television broadcasts and retransmits the broadcasts to Aereo subscribers. Each Aereo subscriber, for \$8 a month, receives a miniature antenna to capture the signal and interact with a cloud-based digital video recorder.

While cable and satellite companies normally pay copyright owners “retransmission consent fees” in order to carry network programming, Aereo does not compensate nor obtain authorization from the broadcasting companies.

Last April, the Second Circuit ruled in favor of Aereo, declaring that such transmissions are not a “public performance,” and thus there is not a violation of the federal Copyright Act. Despite the victory below, Aereo filed cert at the Supreme Court in order to obtain a definitive answer on the issue. Without the Supreme Court stepping in, Aereo alleged, the TV broadcasting industry would otherwise “wage a war of attrition” by re-litigating the issue in every market to which Aereo expands its business.

The Second Circuit decision followed its 2008 decision in *Cartoon Network v. Cablevision*, where it held that Cablevision’s transmission of DVR-recorded programs were not public performances. In so holding, the Second Circuit concluded that one-to-one transmission of a specific program signal is not a public performance. Thus, as the industry brief notes, “so long as no two people can receive the same transmission of a performance, the public performance right is not violated — even if the performance is being transmitted concurrently to thousands of members of the public.”

In the present case, the Second Circuit compared Aereo’s business to a local consumer’s ability to watch and record a program for later viewing (i.e., DVR). In that light, because Aereo assigns each of its users an individual antenna at the time the show is streamed or recorded, the company’s “performance” is private, not public. “Control, exercised after the copy has been created, means that Aereo’s transmissions from the recorded copies cannot be regarded as simply one link in a chain of transmission, giving Aereo’s copies the same legal significance as the RS-DVR copies in *Cablevision*.”

Thus, the Second Circuit held, Aereo is lawfully providing a service to local residents, all of whom could have performed the service themselves, individually. The Supreme Court will hear arguments from Aereo and ABC on April 22.

### IS A CLAIM WITH MULTIPLE, REASONABLE INTERPRETATIONS INDEFINITE?

In *Nautilus v. Biosig*, the Supreme Court will review the Federal Circuit’s test for invalidating an issued patent on grounds of indefiniteness under 35 U.S.C. § 112(b) (pre-AIA). In particular, petitioner Nautilus urges the Supreme Court to reject the Federal Circuit’s requirement that the alleged infringer prove, by clear and convincing evidence, that claims are “insoluble,” i.e., that the claim is “not amenable to construction.”



Patent claims, in delineating the patentee's right to exclude others from making, using and selling the invention, play a critical role in enforcing the core public interests lying at the foundation of the United States patent system. If the patentee fails to draft claims of sufficient precision and definiteness, the public is not adequately informed of the bounds of the protected invention. Instead, the carefully prescribed rights provided to the patentee are inflated, and the contribution to science lessened. Thus, 35 U.S.C. § 112(b) requires that patent claims "particularly point[] out and distinctly claim[]" the claimed subject matter; and failure to do so renders the patent indefinite and therefore invalid and unpatentable.

At the Federal Circuit below, a three-judge panel held that the term "spaced relationship" did not suffer from indefiniteness. Although "spaced relationship" arguably permitted multiple, reasonable interpretations by those skilled in the art, the claim was nonetheless amenable to a construction, and therefore, not "insoluble." Petitioner Nautilus now asks the high court to address whether "the Federal Circuit's acceptance of ambiguous patent claims with multiple reasonable interpretations — so long as the ambiguity is not 'insoluble' by a court — defeat[s] the statutory requirement of particular and distinct patent claiming."

The Federal Circuit's test for indefiniteness, Nautilus argues, allows for unreasonable advantages to the patentee and disadvantages to others arising from uncertainty as to their respective rights. This "zone of uncertainty which enterprise and experimentation may enter only at the risk of infringement claims" stifles innovation. Moreover, Nautilus asserts, allowing claims with multiple, reasonable interpretations incentivizes patent drafters to purposefully obfuscate their invention. This may lead to further downstream problems for the judicial

system, where courts are forced to "spend a substantial amount of judicial resources trying to make sense of unclear, overbroad, and sometimes incoherent claim terms."

The Supreme Court will hear arguments on April 28 amidst a flurry of recent debate on indefiniteness, including an August 2013 Government Accountability Office study for Congress that identified "unclear and overly broad patents" as one of the three key factors cited by stakeholders as contributing to the recent increase in patent litigation. All of the patent community will be watching closely, as even a minor change to the definiteness law could have far-reaching implications.

#### **DOES INDUCED INFRINGEMENT REQUIRE DIRECT INFRINGEMENT BY A SINGLE ENTITY?**

In *Limelight v. Akamai*, on April 30, the Supreme Court will review an *en banc* Federal Circuit decision holding that induced infringement involving multiple actors under 35 U.S.C. § 271(b) does not require a single entity to have directly infringed the patent under 35 U.S.C. § 271(a) (direct infringement). The Supreme Court's decision may be momentous for the telecommunication and technology industries, where end users are increasingly interacting with large, multi-component networks to complete multi-step processes.

35 U.S.C. § 271(b), which codifies induced infringement, states that "whoever actively induces infringement of a patent shall be liable as an infringer." Traditionally, courts have held that induced infringement under § 271(b) requires (1) an act of knowing inducement to infringe (with knowledge of the patent); and (2) actual direct infringement of the patent as defined by § 271(a).

The Akamai patents-in-question pertain to website "content-delivery" technology. In particular, the asserted patents claim a

The Federal Circuit's test for indefiniteness, Nautilus argues, allows for unreasonable advantages to the patentee and disadvantages to others arising from uncertainty as to their respective rights.

[MORE>](#)

A 6-5 majority of a sharply-divided Federal Circuit rejected Limelight's argument, holding that "it is not necessary to prove that all the steps were committed by a single entity."

method of rapidly delivering Internet content (e.g., streaming video) to users by rerouting embedded website objects to servers located in close proximity to the user. At the district court, Akamai alleged that Limelight induced infringement of those patented methods by providing content to its users via the claimed methods, and a district court jury subsequently awarded Akamai over \$40 million in lost profits.

On appeal before the Federal Circuit, Limelight asserted there was no induced infringement because there was no direct infringement under § 271(a). Rather, Limelight claimed, no single entity practiced each of the steps of the claimed method: Limelight completed the first several steps and end users performed the last step. Accordingly, Limelight concluded, the district court's ruling on induced infringement failed as a matter of law.

A 6-5 majority of a sharply-divided Federal Circuit rejected Limelight's argument, holding that "it is not necessary to prove that all the steps

were committed by a single entity." Instead, § 271(a) direct infringement may be based on "acts of infringement . . . committed by an agent of an accused infringer or a party acting pursuant to the accused infringer's direction or control."

Leaders of the technology industry have staunchly opposed the Federal Circuit decision, claiming that the court impermissibly created a new basis for patent infringement. Many have also contended that the Federal Circuit's new rule imposes an unreasonable obligation on businesses selling otherwise non-infringing products and services, forcing them to monitor third-party end users.

Other parties, including several biotechnology firms, have backed the Federal Circuit decision, asserting that the new rule closes a significant loophole. Under the new rule, they point out, parties can no longer easily evade the exclusionary rights of method patent holders by having an end user perform the final steps. ■

---

Banner & Witcoff will closely monitor each of these cases over the next several months and will continue to provide updates and analysis in its IP Alerts. To subscribe to these alerts, please contact Chris Hummel at [chummel@bannerwitcoff.com](mailto:chummel@bannerwitcoff.com).



**Supreme IP: The U.S. Supreme  
Court Weighs in on IP Rights**

**Ross A. Dannenberg and R. Gregory  
Israelsen**

***Banner & Witcoff Intellectual  
Property Update***

**September 19, 2014**

# SUPREME IP: THE U.S. SUPREME COURT WEIGHS IN ON IP RIGHTS



BY ROSS A. DANNENBERG & R. GREGORY ISRAELSEN

Starting with *Medtronic, Inc.*

*v. Mirowski Family Ventures, LLC* — analyzed in Banner & Witcoff's Spring 2014 Newsletter — the U.S. Supreme Court considered a number of intellectual property cases in its 2013–14 term. From patent-eligible subject matter to the copyright implications of new technology, the Court's opinions provide guidance on a wide variety of topics, each of which is analyzed below. In addition, as of September 2, 2014, the Supreme Court has granted certiorari in another three cases. These are also introduced below.

## PATENT CASES

### *Alice Corp. v. CLS Bank International*: Patent-Eligible Subject Matter

One of this term's most-watched intellectual property cases was *Alice Corp. v. CLS Bank International*, where the Court reviewed the standard for determining patent-eligible subject matter under 35 U.S.C. § 101. The Court examined judicially created

risk that only one party to an agreed-upon financial exchange will satisfy its obligation, . . . using a computer system as a third-party intermediary." The Court held that the claims at issue in *Alice* were "directed to an abstract idea," and thus not patentable.

The Court elicited a two-step framework to determine whether claims are directed to an abstract idea. In future cases, when a district court addresses this issue, the court must first "determine whether the claims at issue are directed to [a] patent-ineligible concept" — here, an abstract idea. Second, the court must "search for an 'inventive concept' — *i.e.*, an element or combination of elements that is 'sufficient to ensure that the patent in practice amounts to significantly more than a patent upon the [ineligible concept] itself.'"

To determine whether a concept is an abstract idea, the court "must distinguish between patents that claim the 'building blocks' of human ingenuity and those that integrate the building blocks into something more." While the Court acknowledged that "[a]t some level, 'all inventions

Since 2013, the Supreme Court has either heard or granted certiorari in 7 patent cases, 2 copyright cases, and 4 trademark/Lanham Act cases.

exceptions to statutory text; specifically, that "laws of nature, natural phenomena, and abstract ideas are not patentable."

In *Alice*, the claims were directed to a "scheme for mitigating 'settlement risk' — *i.e.*, the

embody, use, reflect, rest upon, or apply . . . abstract ideas," patent claims that "risk disproportionately tying up the use of the underlying' ideas" are excluded as abstract ideas.

[MORE ►](#)

To determine whether a patent applicant has sufficiently “transform[ed] a claimed abstract idea into a patent-eligible application,” the court looks for an “inventive step.” Specifically, “[a] claim that recites an abstract idea must include ‘additional features’ to ensure ‘that the claim is more than a drafting effort designed to monopolize the abstract idea.’” For example, the Court reinforced the notion that the claim must “do more than simply state the [abstract idea] while adding the words ‘apply it.’”

In analyzing the claims at issue, the Court did not “labor to delimit the precise contours of the ‘abstract ideas’ category in this case,” but simply held that “there is no meaningful distinction between the concept of risk hedging in *Bilski v. Kappos*” — which claimed “a longstanding commercial practice” — and the claims in *Alice*. Further, in searching for an “inventive step,” the Court held that the claims covered “‘well-understood, routine, conventional activities’ previously known to the industry. In short, each step does no more than require a generic computer to perform generic computer functions.” Therefore, the claims were not patent eligible under Section 101. In the Court’s view, the claims — if allowed to be patented — would have prevented anyone else from performing any form of computerized intermediated settlement.

***Nautilus, Inc. v. Biosig Instruments, Inc.*: Definiteness Requirement of 35 U.S.C. § 112, ¶ 2**

Section 112 of the Patent Act requires a patent specification to “conclude with one or more claims particularly pointing out and distinctly claiming the subject matter which the applicant regards as [the] invention.” In *Nautilus*, the Court examined “the proper reading of the statute’s clarity and precision demand.” The claims before the Court were

directed to a heart-rate monitor used with exercise equipment. The Court did not express an opinion on the validity of the claims, but held that “a patent is invalid for indefiniteness if its claims, read in light of the specification delineating the patent, and the prosecution history, fail to inform, with reasonable certainty, those skilled in the art about the scope of the invention.” The Court refers to this as the “reasonable-certainty standard.” The Court rejected the Federal Circuit’s previous indefiniteness standard, which considered a claim indefinite “only when it is ‘not amenable to construction’ or ‘insolubly ambiguous.’”

The Court explained several aspects of the Section 112, ¶ 2 inquiry. First, the Court evaluates definiteness “from the perspective of someone skilled in the relevant art.” Second, “claims are to be read in light of the patent’s specification and prosecution history.” Third, the Court measures definiteness “at the time the patent was filed.”

Interestingly, the Court did not reconcile how claim definiteness can be evaluated both in light of the specification *and prosecution history* and *at the time the patent was filed*. Additionally, the Court acknowledged that “applicants face powerful incentives to inject ambiguity into their claims,” and explained that “the patent drafter is in the best position to resolve” ambiguities in claims.

Thus, in *Nautilus*, the Court attempted to achieve a “delicate balance” by establishing a “reasonable-certainty standard” for evaluating definiteness. However, the Court did not provide an illustrative example for how to apply its new standard, instead remanding to the Federal Circuit to reconsider the disputed claims under this new “reasonable certainty” standard.

### ***Limelight Networks, Inc. v. Akamai Technologies, Inc.: Divided Infringement***

In *Limelight*, the Court held that a defendant is not liable for inducing infringement of a patent under 35 U.S.C. § 271(b) when no one has directly infringed the patent under § 271(a). The Court reversed an *en banc* panel of the Federal Circuit, which had held that § 271(b) liability for induced infringement “arises when a defendant carries out some steps constituting a method patent and encourages others to carry out the remaining steps.”

Limelight Networks operates a content-delivery network, “and carries out several of the steps claimed in” a patent for which Akamai is the exclusive licensee. “[B]ut the record is undisputed that Limelight does not” perform all the steps of the claimed method.

The Court relied heavily on the Federal Circuit’s 2008 decision in *Muniauction, Inc. v. Thomson Corp.*, where the Federal Circuit “started from ‘the proposition that direct infringement requires a single party to perform every step of a claimed method.’” The Court did not consider whether that proposition was correct — the question presented being induced infringement under § 271(b), not direct infringement under § 271(a). Instead, the Court “assum[ed] without deciding that the Federal Circuit’s holding in *Muniauction* is correct,” and held that “there has simply been no infringement of [a] method” when “the performance of all the patent’s steps is not attributable to any one person.” In other words, there can be no induced infringement absent a showing of direct infringement.

This holding parallels the Court’s approach to contributory infringement in *Deepsouth Packing Co. v. Laitram Corp.* There the Court

“rejected the possibility of contributory infringement” where “a manufacturer produced components of a patented machine and then exported those components overseas to be assembled by its foreign customers.” Because the machines were never assembled in the United States, there was never direct infringement, and the manufacturer could not be liable for contributory infringement. “Similarly, in this case, performance of all the claimed steps cannot be attributed to a single person, so direct infringement never occurred.” The Court therefore held that Limelight was not liable for induced infringement.

### ***Octane Fitness, LLC v. Icon Health & Fitness, Inc., and Highmark Inc. v. Allcare Health Management System, Inc.: Standard for Awarding Attorneys’ Fees in Patent-Infringement Cases***

Section 285 of the Patent Act provides that “[t]he court in exceptional cases may award reasonable attorney fees to the prevailing party.” In *Octane Fitness, LLC v. Icon Health & Fitness, Inc.*, the Court considered the proper approach for evaluating a request for fees under § 285. The district court, after granting Octane Fitness’s motion for summary judgment of non-infringement, denied Octane’s request for fees under the approach established in 2005 by the Federal Circuit in *Brooks Furniture Mfg., Inc. v. Dutilleul Int’l*. The *Brooks Furniture* approach limited the award of attorney fees in patent cases to “when there has been some material inappropriate conduct” or when the litigation is both “brought in subjective bad faith” and “objectively baseless.” The Federal Circuit affirmed both orders.

On review, the Court unanimously rejected the *Brooks Furniture* approach. The Court explained that the *Brooks Furniture* [MORE ▶](#)

approach is “unduly rigid, and impermissibly encumbers the statutory grant of discretion to district courts.” Instead, the analysis “begins and ends with the text of § 285 . . . This text is patently clear.” The only constraint on district courts’ discretion to award attorney fees is that they do so only in “exceptional cases.” An exceptional case is “simply one that stands out from others with respect to the substantive strength of a party’s litigating position . . . or the unreasonable manner in which the case was litigated.” Thus, a district court “may determine whether a case is ‘exceptional’ in the case-by-base exercise of their discretion, considering the totality of the circumstances.” Further, according to the Court, this approach is not new, but rather a return to the standard used from 1946 to 2005.

Additionally, the Court rejected *Brooks Furniture’s* clear-and-convincing-evidence standard of proof required for patent litigants to prove entitlement to fees. Section 285 does not require a “specific evidentiary burden, much less such a high one.” Instead, the correct standard of proof is a preponderance of the evidence, “because it ‘allows both parties to share the risk of error in roughly equal fashion.’”

The Court therefore reversed the Federal Circuit, and remanded the case for review using the correct standard.

On remand, the Federal Circuit itself remanded the *Octane Fitness* case back to the district court. In doing so, the Federal Circuit reminded the district court that it is not *obligated* to award fees if a case is determined to be exceptional, but rather may choose to do so at its discretion.

In *Highmark Inc. v. Allcare Health Management System, Inc.*, argued together with *Octane Fitness*, the Court considered the standard for reviewing a district court’s award of fees under § 285.

Citing the Court’s focus on the text of § 285 in *Octane Fitness*, the Court held that “[b]ecause § 285 commits the determination of whether a case is ‘exceptional’ to the discretion of the district court, that decision is to be reviewed on appeal for abuse of discretion.” Therefore, the Court reversed and remanded the case to the Federal Circuit for review of the district court’s fee grant using an abuse-of-discretion standard.

### COPYRIGHT CASES

#### *American Broadcasting Companies, Inc. v. Aereo, Inc.*: Meaning of “Public Performance” Under Copyright Act

Another closely watched intellectual property case this term was *American Broadcasting Companies, Inc. v. Aereo, Inc.* A 6–3 majority of the Court held that Aereo infringed the exclusive right to “perform [a] copyrighted work publicly” when “selling its subscribers a technologically complex service that allows them to watch television programs over the Internet at about the same time as the programs are broadcast over the air.”

Aereo’s system includes thousands of tiny antennas in a central location, which individual users may use to watch over-the-air broadcast content. When a user selects content to watch, a single antenna is allocated to that user — and only that user — and the content received by that antenna is transmitted over the Internet to that user. The user can thus watch over-the-air content over the Internet nearly simultaneously with the over-the-air broadcast.

The Court analyzed two questions in determining whether Aereo infringed the right to perform a copyrighted work publicly. First, “does Aereo ‘perform’ at all? And second, if so, does Aereo do so ‘publicly?’”

In analyzing whether Aereo performs, the Court admitted that “the language of the Act does not clearly indicate when an entity ‘perform[s]’ . . . and when it merely supplies equipment that allows others to do so.” The Court analogized Aereo’s technology to cable TV (CATV) technology of 40 years ago. CATV providers “placed antennas on hills above” cities, then “amplified and modulated the signals” to rebroadcast them to customers. In 1968 and 1974, the Court held that CATV systems did not infringe the copyrights of the content they rebroadcast; “[v]iewers do not become performers by using ‘amplifying equipment’ and a CATV provider should not be treated differently for providing viewers the same equipment.” But in 1976, Congress amended the Copyright Act “to reject the Court’s holdings . . . [and] to bring the activities of cable systems within the scope of the Copyright Act.”

Even though the Court acknowledged a “particular difference between Aereo’s system” and CATV systems — that only “in automatic response to the subscriber’s request does Aereo’s system activate an antenna and begin to transmit the requested program” — the Court “d[id] not see how this single difference, invisible to subscriber and broadcaster alike, could transform a system that is for all practical purposes a traditional cable system into” one that does not “perform” within the scope of the Copyright Act.

In analyzing whether Aereo performs “publicly,” the Court similarly ignored “technological differences” between Aereo’s system and traditional cable systems. In the Court’s view, “Congress would as much have intended to protect a copyright holder from the unlicensed activities of Aereo as from those of cable companies.” Thus, the Court interpreted “the public” to apply to “a group of individuals acting as ordinary members

of the public who pay primarily to watch broadcast television programs.”

Even though the Court held that Aereo infringed the right of public performance, the Court stressed that “we do not believe that our limited holding” will “discourage or control the emergence or use of different kinds of technologies.” The Court specifically noted that “questions involving cloud computing, remote storage DVRs, and other novel issues not before the Court” are not covered by its holding. Justice Scalia authored a strong dissent.

It remains to be seen if “Congress will take a fresh look at this new technology” and “decid[e] whether the Copyright Act needs an upgrade.” But for now, the Court limited its holding to Aereo’s system and others like it, thus hoping to avoid disturbing future investments in and development of other new technologies.

### ***Petrella v. Metro-Goldwyn-Mayer, Inc.:* Applicability of Laches to Copyright- Infringement Claims**

In *Petrella*, a 6–3 majority of the Court held that laches cannot be invoked as a bar to a copyright-infringement claim for damages brought within the Copyright Act’s three-year statute of limitations. The author’s daughter, Paula Petrella, inherited the copyright to a 1963 screenplay on which the 1980 MGM film *Raging Bull* was based. She sued MGM for infringement in 2009. Petrella “sought no relief for conduct occurring outside” the three-year limitations period, but the district court and the Ninth Circuit nevertheless invoked laches as a bar to relief, because Petrella *could have* brought her claim earlier.

Congress established “a right to sue for infringement occurring no more than three years back from the time of suit,” [MORE ►](#) and “[t]hat regime leaves ‘little



[SUPREME IP, FROM PAGE 21]

place' for a doctrine that would further limit the timeliness of a copyright owner's suit." The Court did, however, recognize that "the consequences of a delay in commencing suit may be of sufficient magnitude" to limit the amount or type of relief that may be rewarded. For example, in *Chirco v. Crosswinds Communities, Inc.*, the owner of a copyrighted architectural design was not "entitled to an order mandating destruction of" a housing development in which more than 168 units were built, with 109 units occupied. That relief would be inequitable for two reasons: "the plaintiffs knew of the defendants' construction plans before the defendants broke ground, yet failed to take readily available measures to stop the project; and the requested" destruction would be "an unjust hardship' upon the defendants and innocent third parties."

Petrella's claim did not present the kind of extraordinary circumstances that would bar some types of relief at the outset. "Allowing Petrella's suit to go forward will put at risk only a fraction of the income MGM has earned during [the past three decades] and will work no unjust hardship on innocent third parties." The Court noted, however, that if Petrella ultimately prevails, the district court "may take account of her delay in commencing suit" when determining

appropriate damages. But her delay cannot completely "foreclos[e] the possibility of any form of relief."

### CASES FOR 2014-2015 TERM

While not hearing a single trademark case in its previous term, the Court has already granted certiorari of two trademark cases for its next term, plus an additional patent case:

- *Teva Pharmaceuticals USA, Inc. v. Sandoz, Inc.*: The Court will consider the appropriate standard for reviewing a district court's factual findings in patent claim construction.
- *B&B Hardware v. Hargis Industries*: The Court will consider whether the Trademark Trial and Appeal Board's finding of likelihood of confusion precludes a respondent from relitigating that issue in infringement litigation.
- *Hana Financial v. Hana Bank*: The Court will consider whether the jury or the court determines whether use of an older trademark may be tacked to a newer one.

As always, Banner & Witcoff attorneys will watch these and other cases before the Court, and provide updates and analysis as more information becomes available. ■



## JOSEPH M. POTENZA ELECTED ABA-IPL REPRESENTATIVE TO THE ABA HOUSE OF DELEGATES

Joseph M. Potenza was elected as the American Bar Association Section of Intellectual Property Law (ABA-IPL) Representative to the ABA House of Delegates during the organization's Annual Meeting in Boston, Aug. 6-12, 2014. He will serve a three-year term, expiring in 2017.

**TRADEMARKS**



**Trademarks by Design: Combining  
Design Patents and Trademarks to  
Protect Your Intellectual Property**

**Robert S. Katz, Helen Hill Minsker  
and Erik S. Maurer**

***American Intellectual Property Law  
Association Spring Meeting***

**March 2014**



BANNER & WITCOFF, LTD.  
INTELLECTUAL PROPERTY LAW

## Trademarks by Design: Combining Design Patents and Trademarks to Protect Your Intellectual Property

March 2014

### Authors:

- **Robert S. Katz**, Principal Shareholder, Washington, DC – [rkatz@bannerwitcoff.com](mailto:rkatz@bannerwitcoff.com)
- **Helen Hill Minsker**, Principal Shareholder, Chicago – [hminsker@bannerwitcoff.com](mailto:hminsker@bannerwitcoff.com)
- **Erik S. Maurer**, Principal Shareholder, Chicago – [emaurer@bannerwitcoff.com](mailto:emaurer@bannerwitcoff.com)

**Chicago, IL**  
Ten South Wacker Drive  
Suite 3000  
Chicago, IL 60606

**Washington, DC**  
1100 13<sup>th</sup> Street NW  
Suite 1200  
Washington, DC 2005

**Boston, MA**  
28 State Street  
Suite 1800  
Boston, MA 02109

**Portland, OR**  
121 SW Salmon Street  
11<sup>th</sup> Floor  
Portland, OR 97204

[www.bannerwitcoff.com](http://www.bannerwitcoff.com)

## INTRODUCTION

Design patents and trademarks are separate species of intellectual property (IP), but each can provide significant commercial advantages to their owners. Design patents grant the inventor exclusive rights to the invention for a period of fourteen years which will soon be changed to fifteen years. However, at the end of that time, the design invention is dedicated to the public unless it is protected by another intellectual property right. Trademarks, if properly maintained, can exist forever. With the growing importance of IP rights, old ideas, such as combining trademarks and design patents, deserve another look as a means to accomplish this. Moreover, with the Supreme Court's declaration in *Wal-Mart Stores, Inc., v. Samara Brothers, Inc.*, 529 U.S. 205 (2000), that secondary meaning is required before certain types of product designs are entitled to trade dress protection, design patents may be the most effective way to ward off infringers while secondary meaning for trademarks and/or trade dress is established. This article addresses the relationship between design patent protection and trademark protection and described the strategy of using the combination of these rights.

## THE LEGAL FRAMEWORK

The Patent Law provides for the granting of design patents to any person who has invented any new, original and ornamental design for an article of manufacture. Design patents cover the way an article looks, and may be drawn to the shape/configuration of an article, surface ornamentation applied to the article, or a combination of both. A design patent does not need to be directed to the entire article, and claiming a portion of the article is permitted, *In re Zahn*, 617 F.2d 261 (CCPA 1980). During the soon to be fifteen year term, the owner of the patent has the right to exclude others from making an infringing design.

A trademark is any word, name, symbol, or device that serves as an indicator of source. Thus, the shape of article can serve as a trademark provided that all other requirements are met. Although an application to register a trademark can be filed before a mark is actually in use, ultimately trademark rights arise, and can only be maintained, through use of a mark. Federal trademark registrations carry a presumption that the registration is valid and the registrant has the exclusive right to use the mark. The term of a federal registration is ten years, with renewals available in ten-year increments, so long as the mark remains in use.

Both design patents and trademarks are entitled to a variety of statutory remedies, which may include damages, infringer's profits, injunctions, and under certain circumstances, attorneys' fees. Differences relating to injunctive relief are addressed later in this article. However, not all remedies are available under all circumstances, so the facts of a particular case must be reviewed to determine which remedies are possible.

## INTERPLAY BETWEEN DESIGN PATENTS AND TRADEMARKS

In many instances, the same design can be protected by trademark and design patent laws. Examples of well-known design trademarks which also have been the subject of design patents include the DUSTBUSTER® vacuum cleaner, the APPLE iPod® electronic music player, and the NIKE Air Max 1995® shoe upper.

At first blush, combining design patents and trademarks might seem contrary to public policy -- design patents grant a limited period of protection for a design, while trademark law may provide perpetual protection for the same design. However, the CCPA (predecessor to the Court of Appeals for the Federal Circuit) made it clear in *In re Mogen David Wine Corporation*, 328 F.2d 925 (CCPA 1964) and *In re Honeywell, Inc.*, 328 F.2d 925 (CCPA 1974), that trademark rights exist independently of design patent rights. Trademark protection is granted to prevent the public from being confused, while the purpose of design patents is to encourage inventors to develop novel, ornamental designs. However, trademark protection is not extended to designs that are merely ornamental and are not indicators of source. For example, in *In re Owens-Corning Fiberglas Corp.*, 774 F.2d 1116 (Fed. Cir. 1985), a key issue was whether the color pink for fiberglass insulation was merely ornamentation, or whether it was an indicator of source.

The e-commerce revolution has underscored the need to protect IP assets in cyberspace, such as the appearance of computer screen displays and web pages. Designs, such as computer icons, are now commonly protected in various forms through both design patents and trademarks. For example, Sun Microsystems has the coffee cup symbol for its JAVA® product registered as a trademark, and also has a design patent (where the coffee cup is combined with the words “JAVA WORKSHOP”). Thus, a combination of design patent and trademark protection may be the most effective way to protect your trademarks, trade dress and designs in cyberspace.

## FUNCTIONAL V. ORNAMENTAL

A design patent protects the ornamental appearance of the article of manufacture and not its structural or utilitarian features. Articles protected under the design patent laws must be “primarily ornamental” and not “primarily functional,” *L.A. Gear Inc. v. Thom McAn Shoe Co.*, 988 F.2d 1117 (Fed. Cir. 1993). However, in a design patent context, “primarily functional” is not construed as broadly as the phrase might suggest. In determining whether a design is “primarily functional” or “primarily ornamental,” the claimed design is viewed in its entirety, not on a feature-by-feature basis, *L.A. Gear, supra*. If the functional aspects of the design could be accomplished in other ways, it is likely to be primarily ornamental. *Rosco, Inc. v. Mirror Lite Co.*, 304 F. 3d 1373 (CAFC 2002). However, if a design is dictated solely by the functionality of its article of manufacture, it is not patentable, *Best Lock Corp. v. Ilco Unican Corp.*, 94 F.3d 1563 (Fed. Cir. 1996). For most designs, the issue of functionality is not likely to create a problem during the prosecution of the design patent application, but it may arise during litigation.

Trademark protection is not available for designs that are merely ornamental, nor is it available for designs that are de jure functional. In contrast to the design patent process, functionality likely will be raised as an issue during the prosecution of a trademark application, and also may arise during litigation.

If a design is “de jure functional” (functional as a matter of law), it will never be registrable as a trademark. A design is functional as a matter of law if it is “essential to the use or purpose of the article or if it affects the cost or quality of the article.” *TrafFix Devices, Inc. v. Mktg. Displays, Inc.*, 532 U.S. 23, 33, (2001); *Qualitex Co. v. Jacobson Prods. Co.*, 514 U.S. 159, 165, (1995); *Inwood Labs., Inc. v. Ives Labs., Inc.*, 456 U.S. 844, 850, n.10, (1982).

However, a design that is “de facto functional” (functional as a matter of fact), still may be either inherently distinctive or capable of acquiring distinctiveness, and therefore be registrable. For example, in *In re Morton-Norwich Products Inc.*, 671 F.2d 1332 (CCPA 1982), a bottle with a pump for spraying liquid was found de facto functional -- the elements of the mark were used to store and spray liquid -- but potentially registrable as a trademark, provided the owner could prove that the trademark had acquired distinctiveness. (The design in *Morton-Norwich* also was the subject of a design patent.)

It should also be noted that if the product features sought to be protected as a mark were the subject of an expired utility patent, this “adds great weight to the statutory presumption that features are deemed functional until proven otherwise” and that one who seeks such protection “must carry the heavy burden of showing that the feature is not functional.” *TrafFix Devices v. Marketing Displays, Inc.*, 532 U.S. 23 (2001).

Another type of functionality that may also be cited to preclude trademark protection in certain circumstances is “aesthetic functionality.” In contrast to utilitarian functionality, “aesthetic functionality” refers to situations where the feature may not provide a truly utilitarian advantage in terms of product performance, but provides other competitive advantages. (Aesthetic functionality inquiries may look at whether the design would put competitors at a significant non-reputation related disadvantage). Cases in which aesthetic functionality has been addressed cover such diverse products as black outboard motors (*Brunswick Corp. v. British Seagull Ltd.*, 35 F.3d 1527 (Fed. Cir. 1994), *cert. denied*, 514 U.S. 1050 (1995)), red soles on shoes (*Christian Louboutin S.A. v. Yves Saint Laurent America, Inc.*, 696 F.3d 206 (2d Cir. 2012)), red wax seals on whiskey bottles (*Maker’s Mark Distillery, Inc. v. Diageo North America Inc.*, 679 F.3d 410, 418-19 (6th Cir. 2012) and a basketweave pattern on leather goods (*In re Bottega Veneta International S.a.r.l.*, Appl. No. 77219184 (TTAB Sept. 30, 2013)).

Although some types of designs are inherently distinctive, and automatically entitled to trademark protection, for many designs (particularly product configurations), acquired distinctiveness (secondary meaning) must be shown. In *Wal-Mart*, the Supreme Court made a distinction between product designs and packaging designs. While the Court agreed that a packaging design could be inherently distinctive, it held that a product design may only be protectable trade dress if secondary meaning has been demonstrated.

## **OBTAINING TRADEMARK REGISTRATIONS FOR DESIGNS**

The registrability of design trademarks often hinges on demonstrating that the design is not de jure functional. Thus, the PTO and courts look at factors, such as whether the design is the subject of a utility patent or a design patent. If it is the subject of a utility patent, there at least is a presumption that the design is de jure functional and not registrable as a trademark. In contrast, because design patents cover primarily ornamental designs, the existence of a design patent can provide strong evidence that a design is not de jure functional. Advertising for a product is also a factor in determining whether a design is de jure functional. Does the IP owner advertise the utilitarian functions of the design, or does it use advertising to demonstrate that the design is an indicator of source? Additional factors in determining whether a design is de jure functional include whether there are alternative designs available to competitors, and whether the design results from a comparatively cheap, simple method of manufacturing the product.

While the latter two factors may bar even a distinctive design from registration, the first two factors, the presence or absence of a design patent and advertising for a product, can be most useful in establishing a trademark for the product. It often takes many years, and substantial advertising expenditures, before the public will recognize a design as a trademark. Thus, Owens-Corning hired the Pink Panther to urge us to “THINK PINK,” as it sought to register pink as a trademark for fiberglass insulation and United Parcel Service asked us to consider “What Can Brown Do For You?” in its effort to protect the color brown for its delivery services. Such advertising campaigns are rarely successful overnight, so the design patent’s term to exclude can be used to develop public awareness that a particular design is also an indicator of source. Now that the Supreme Court has raised the bar for protecting product designs, the period of exclusivity granted by a design patent becomes even more important in protecting IP rights.

## **DIFFERENT RIGHTS, POTENTIALLY DIFFERENT REMEDIES**

In general, design patent lawsuits are subject to the same precedents that control utility patent lawsuits. To that end, for example, design patent plaintiffs must satisfy the *eBay* requirements to obtain permanent injunctive relief, and courts will not presume the existence of irreparable harm when infringement is found. *eBay Inc. v. MercExchange, L.L.C.*, 547 U.S. 388 (2006).

Notably, irreparable harm requires showing a causal nexus between the infringing design and the plaintiff’s injury. *Apple, Inc. v. Samsung Electronics Co., Ltd.*, 735 F.3d 1352, 1362-63 (Fed. Cir. 2013). For example, in *Apple v. Samsung*, the district court denied permanent injunctive relief because Apple could not show that the infringing design features drove consumer demand for the accused Samsung products. *Id.*

On appeal, the Federal Circuit cautioned against overly rigid standards for demonstrating causal nexus because *eBay* is premised in flexible principles of equity. *Id.* at 1364. Nevertheless, the Federal Circuit affirmed denial of a permanent injunction against Samsung’s design patent infringements, agreeing that “Apple must show some connection between the patented feature and demand for Samsung products,” and the district court’s findings would not be disturbed under the controlling standard of review. *Id.*

Trademarks, in contrast, may yet afford an automatic entitlement to a permanent injunction against on-going violations – provided the asserted mark is famous and liability flows from dilution. Here, the Federal Trademark Dilution Revision Act of 2006 (“FTDA”) provides that the owner of a famous mark is entitled to an injunction against marks that are “likely to cause dilution by blurring or dilution by tarnishment of the famous mark, regardless of the presence or absence of actual or likely confusion, of competition, or of actual economic injury.” 15 U.S.C. § 1125(c)(1).

This situation might have played out in *Apple v. Samsung*, but for the fact Samsung stopped selling phones that were found to dilute Apple’s famous iPhone trade dress before the district court addressed the issue of post-judgment permanent injunctive relief. There, the district court exercised its discretion to deny a permanent injunction because it was undisputed that Samsung voluntarily stopped its diluting conduct. *Apple, Inc. v. Samsung Electronics Co., Ltd.*, 909 F.Supp.2d 1147, 1158 (N.D.Cal. 2012). On appeal, the Federal Circuit affirmed denial of a



permanent injunction against the diluting phone designs, but avoided the direct question of whether the FTDA would otherwise automatically authorize issuance of permanent injunction. *Apple*, 735 F.3d 1373-74, n.9. Instead, the Federal Circuit interpreted Ninth Circuit precedents, concluding that the district court could have issued an injunction notwithstanding Samsung's voluntary cessation, but that the court acted within its discretion. *Id.* at 1375.

## **DESIGN PATENT, TRADEMARK OF BOTH?**

Not all designs warrant obtaining both design patent and trademark protection. The following factors are just some of the relevant considerations in deciding what protection is appropriate:

1. The importance and life expectancy of the design. If the design is of great importance, then both design patent and trademark protection may be warranted. If it will have a relatively short commercial life, then design patent protection alone may be sufficient.
2. The nature of competitors: is this an industry where copying is rampant? If copying is the norm, then obtaining the maximum protection through both design patents and trademark registrations may be critical.
3. Cost of asserting rights: Developing a winning evidentiary record in a trademark case may require extensive surveys and be more costly than preparing the evidence for a design patent case. On the other hand, if the design patent is more narrow than the scope of trademark protection, it may be worth the risk of additional cost to prove trademark infringement.
4. The relative ease/difficulty of registering the design under the trademark and the design patent law. If the design lacks inherent distinctiveness or secondary meaning, then a design patent may provide a quick means of securing protection. Design patents typically issue in 1-1/2 years, while a trademark registration for a mark that faces a functionality objection may face many years of prosecution (or persecution, depending on your viewpoint) before a registration issues.
5. Budget: will the design fit in a single design patent or trademark application, or are multiple applications required? If budget is a factor, look to see whether elements of the design require individual or collective protection, and then determine which type of protection is most economical.
6. Time: Has more than one year passed since the design was on sale or in public use? If so, then design patent protection is precluded by statute, but trademark protection may still be available.
7. If a design is not inherently distinctive, can it be turned into a trademark through a targeted advertising campaign, such as the "THINK PINK" campaign of Owens-Corning? If so, use the design patent's term of exclusivity to develop consumer goodwill. At the very least, use it to obtain the five years of substantially exclusive use needed to register the trademark on the basis of acquired distinctiveness.

8. Audit your IP portfolios regularly. Many changes will occur in the marketplace during the life of a design patent. Look at your design patent portfolio periodically to see whether any of the designs deserve trademark protection.

## **NOW & THEN – THINK AHEAD**

Savvy counsel will explain to their clients how the relative ease of acquiring 14 (or 15) years of design patent protection for a new design contrasts with the rigorous requirements for later proving acquired distinctiveness and perpetual trademark rights in that design. For aspiring soothsayers aiming to predict the next iconic design, keep the following issues in mind.

**Consistently define the design from the outset** – claiming parts of a design in a patent should be consistent, or at least compatible, with future trade dress definitions. Here, issuance of a design patent covering some or all of the future claimed trade dress can bolster non-functionality and distinctiveness arguments.

**Beware functionality** – counsel clients to distinguish functional and ornamental properties of industrial design. Ensure that in-house and outside teams are coordinating on utility and design patent prosecution, and that trademark counsel is engaged where significant new designs are being launched. Regional circuit law controls trade dress functionality analyses and aesthetic functionality should be a consideration. Work with clients to highlight the ornamental, non-functional, and recognizable aspects of industrial designs.

**Be smart with agreements** – trademarks are vessels of goodwill that must be mindfully protected. Design patents, on the other hand, are property rights that can be enforced – or not – as clients and their budgets direct. Beware that failure to police design infringements and licensing of design rights without thought to associated goodwill could defeat future claims to owning protectable trade dress.

These are but some of the considerations counsel should discuss with design-focused clients. In sum, patents and trademarks are different rights that provide different protections at different points in time. Savvy counsel will survey the field of play from thirty-thousand feet well before advising clients about on-the-ground tactics.

In short, analyze whether design patent protection is available, whether trademarks already exist in the designs you have, or whether they can be trademarks by design, and select your protection accordingly.



**Aesthetic Functionality in the TTAB  
since *Louboutin***

**Anna L. King**

***Banner & Witcoff Intellectual  
Property Update***

**April 21, 2014**

## AESTHETIC FUNCTIONALITY IN THE TTAB SINCE LOUBOUTIN



BY: ANNA L. KING

The doctrine of aesthetic functionality was revived in the recent *Louboutin* case to protect the competitive need to use color to communicate a particular message. In that case, Christian Louboutin S.A. tried to enforce its trademarked red lacquered outsole against Yves Saint Laurent's use of the color red on a monochromatic shoe (including on the outsole). *Christian Louboutin S.A. v. Yves Saint Laurent America, Inc.*, 778 F. Supp. 2d 445, 447-48 (S.D.N.Y. 2011). The district court relied on *Qualitex*, finding that color would only be protectable if it distinguishes one's goods and identifies their source, without serving a function. *Qualitex Co. v. Jacobson Prods. Co.*, 514 U.S. 159, 162 (1995). It accordingly held that Louboutin's red outsole served non-trademark functions, such as eluding energy and sexiness, and could not be upheld as a trademark as it would hinder creativity and artistic freedom in the fashion industry to preclude competitors from using the color on shoes.

The U.S. Court of Appeals for the Second Circuit reversed the district court's decision. It noted that to uphold the district court's decision would be to single out the fashion industry and hold it to a different standard than other industries. It reviewed Louboutin's evidence of acquired distinctiveness of the mark and determined that it had little support for acquired distinctiveness extending to uses where the red outsole did not contrast with the upper portion of the shoe (e.g., monochromatic shoe like that of YSL). Thus,

it held that Louboutin's red outsole is entitled to limited protection as a trademark. *Christian Louboutin S.A. v. Yves Saint Laurent America Holding, Inc.*, 696 F.3d 206 (2d Cir. 2012). This protection amounts to a limitation of the red outsole registration to situations where the red outsole contrasts in color with the upper portion of the shoe.

This was seen as a win for the fashion industry as well as for both parties. The fashion industry was allowed once again to protect single colors as trademarks. As for the parties, Louboutin viewed it as validation of its trademark albeit in limited circumstances, and YSL interpreted it as a win because it was allowed to continue to use red soles on monochromatic red shoes. The decision also provided a test for aesthetic functionality. The decision held that a mark is aesthetically functional and therefore ineligible for trademark protection if: (1) the design feature is essential to the purpose of the good; (2) the design feature affects the cost or quality of the product; and (3) protection of the design feature would significantly hinder competition.

In 2013, the Trademark Trial and Appeal Board addressed the issue of aesthetic functionality and provided some guidance into the "competitive need" factor in two noteworthy cases. In the first case, *Florists' Transworld Delivery (FTD)* attempted to register the color black for packaging for its flower arrangements. *In re Florists' Transworld Delivery, Inc.*, 106 USPQ2d 1784 (TTAB 2013). The Board echoed the Second Circuit's test in *Louboutin*; however, it focused its analysis on the issue of competitive need to consider whether a single color can be registered as a trademark for a particular product. The Board also cited to an earlier case noting that "functionality hinges on whether registration of a particular feature hinders competition and not whether the



[MORE >](#)



*Drawing and specimen images from U.S. Trademark serial No. 77590475*

These recent decisions indicate that the doctrine of aesthetic functionality is likely here to stay.

feature contributes to the product's commercial success." *M-5 Steel Mfg. Inc. v. O'Hagin's Inc.*, 61 USPQ2d 1086, 1097 (TTAB 2001).

The Examining Attorney submitted evidence that color has significance in the floral industry and noted that the color black, in particular, serves an aesthetic function in relation to floral packaging. It is associated with an elegant, classic look. It is also a color to communicate grief or condolence as well as a color associated with Halloween. Accordingly, he argued, and the Board agreed, the color black is necessary in the floral industry to communicate these messages and allowing FTD to own exclusive rights to the color black for floral packaging would hinder competition.

In a concurrence opinion, Judge Bucher agreed with the results of the majority, but indicated that instead of attempting to negotiate the various functionality cases and categorize each case into a pre-existing label such as "aesthetic functionality," he would instead apply "first principles." This would simply ask if "public interest is best served by refusing to permit a particular feature to be taken from the 'public domain.'" He indicates that the answer will turn "on whether the non-traditional indicator should remain permanently available for competitors to use freely."

In a subsequent decision, the Board did not adopt this simplified test, but again considered the doctrine of aesthetic functionality when considering the registrability of Bottega Veneta's basket-weave pattern used on its leather

products. *In re Bottega Veneta International S.a.r.l.*, Serial No. 77219184 (September 30, 2013) [non-precedential]. The Board again focused on the competitive need to use the particular design. In this case, the Examining Attorney submitted many examples of uses of weave patterns to show the competitive need for such designs; however, the Board noted that the patterns submitted into evidence were all distinct from the applied for mark. In view of the very narrow description Bottega Veneta submitted for its mark ("a configuration of slim, uniformly-sized strips of leather, ranging from 8 to 12 millimeters in width, interlaced to form a repeating plain or basket-weave pattern placed at a 45-degree angle over all or substantially all of the goods") and the lack of any designs submitted into evidence that totally matched the description of the weave design, the Board held that there was not a competitive need for this particular design of weave for leather goods. As Bottega Veneta was also able to prove acquired distinctiveness, the design was allowed to register.



*Drawing from U.S. Trademark serial No. 77219184*

These recent decisions indicate that the doctrine of aesthetic functionality is likely here to stay. It is also apparent that courts and the Trademark Trial and Appeal Board are willing to continue providing protection for designs and colors where exclusive rights thereto would not be perceived as restricting a competitor's need. What constitutes a "competitor's need" will continue to be an industry specific analysis and relate to the commercial message being conveyed by the particular color or design. Thus, the lessons learned from these cases are to know the particular market at issue and consider how the specific color or pattern is perceived in that market before pursuing trademark protection. ■



**NFL Teams 0-2 in the TTAB**

**Helen Hill Minsker**

***Banner & Witcoff Intellectual  
Property Update***

**September 19, 2014**

## NFL TEAMS 0-2 IN THE TTAB



BY HELEN HILL MINSKER

This past summer yielded two interesting decisions from the Trademark Trial and Appeal

Board (TTAB) of the U.S. Patent and Trademark Office (USPTO) involving NFL teams. In the Washington Redskins case, the TTAB cancelled several registrations owned by the Washington Redskins that included the word “Redskins” on the ground that the term was disparaging. Although for different reasons than the Washington Redskins case, the New York Giants likewise found an unsympathetic ear in the TTAB when it attempted to register the term “G-MEN.”

**Marketplace Fame & Use Evidence Isn't Enough to Avoid Likelihood of Confusion: *In re New York Football Giants, Inc.*, (TTAB July 3, 2014) (unpublished)**

The New York Football Giants sought to register “G-MEN” for “shirts; t-shirts; tops” in Class 25 (SN 85599795). The USPTO refused registration on the basis of likelihood of confusion with a prior registration for GMAN Sport for “boxer shorts; socks; t-shirts; tank tops,” also in Class 25.



The Giants tried mightily to convince the TTAB that even though there was overlap in the description of the goods in their application and the cited registration, and no restrictions on the intended uses or channels of trade, the mark “G-MEN” in its application is so famous that there was no likelihood of confusion. As the TTAB noted at the outset of its opinion,

“The essence of Applicant’s argument as to why there is no likelihood of confusion is that its G-MEN mark is (1) so famous that (2) when used in the context of football related merchandise, it has a unique and singular meaning for a distinct set of products.”

Per the Giants, “[t]here is no more fundamental and grievous error than to conclude that confusion is likely by comparing two marks in the abstract, divorced from marketplace circumstances...” The TTAB boiled down the Giants’ argument to the proposition that if the Applicant produces evidence of record relating to the fame of its mark, and the nature of the goods/channels of trade for the goods, then “... the lack of express restrictions or limitations in the respective descriptions of the goods is no longer relevant.” The problem for the Giants, according to the TTAB, is that this interpretation is expressly contrary to longstanding TTAB and Federal Circuit law.

The TTAB, which seemed to be somewhat frustrated by the position taken by the Applicant, notes that usually, when this type of argument is made, it is because the Applicant fails to recognize that Board precedent requires it to take into account the specific identification of the goods in the application. Here, the TTAB noted, “... Applicant’s counsel appears not to have ignored such precedent, but to have made a direct argument that application of such precedent, over the course of many years, has been improper and the Board’s focus, in likelihood of confusion cases, on broadly construed identifications, has been in error.”

The TTAB then proceeded to provide a primer on its longstanding precedent that requires it to focus on the

[MORE ►](#)

[NFL TEAMS, FROM PAGE 7]

similarity or dissimilarity of the goods *as described in an application or registration*. Having concluded that, under its precedent, the goods as described in the application are overlapping, the TTAB also found the Giants

by the boundaries of the description in the application or registration, and the type of marketplace analysis that courts typically make in assessing likelihood of confusion in an infringement context. The Supreme Court

## “There are fundamental differences between how the TTAB looks at likelihood of confusion and how a court analyzes the issue.”

arguments relating to the other factors considered in determining likelihood of confusion were not persuasive, and it affirmed the refusal to register the mark.

This case provides a good example of the differences between the analysis of likelihood of confusion in a registrability proceeding, which is constricted significantly

presently has before it the case of *B&B v. Hargis*, where it will weigh how much deference, if any, courts should give to a TTAB decision on likelihood of confusion. The Giants case is a reminder that even though some aspects of the analysis may be similar, there are fundamental differences between how the TTAB looks at likelihood of confusion and how a court analyzes the issue. ■

## DONALD W. BANNER DIVERSITY SCHOLARSHIP FOR LAW STUDENTS

Banner & Witcoff is proud to offer the Donald W. Banner Diversity Scholarship for law students. This scholarship is part of the firm's commitment to fostering the development of intellectual property lawyers from diverse backgrounds.

Law students who meet the selection criteria and have entered into a J.D. program at an ABA-accredited law school in the United States are eligible to apply for the scholarship. Applicants may not be a current or past employee of Banner & Witcoff, or directly related to a current employee of the firm.

Application materials are now available for the 2015 scholarship award. Please visit [www.bannerwitcoff.com/diversity](http://www.bannerwitcoff.com/diversity) for more information.



BANNER&WITCOFF  
COMMITMENT TO DIVERSITY







**NFL Redskins Federal Trademark  
Registrations Cancelled**

**Ernest V. Linek**

***Banner & Witcoff Intellectual  
Property Update***

**September 19, 2014**

## NFL REDSKINS FEDERAL TRADEMARK REGISTRATIONS CANCELLED



BY: ERNEST V. LINEK

On June 18, 2014, in a 2-1 decision in *Blackhorse v. Pro Football, Inc.*, the Trademark Trial and Appeal Board (TTAB)

of the United States Patent and Trademark Office (USPTO) cancelled six federal registrations for trademarks that include the term “Redskins.”

In the Federal Trademark Cancellation Action (No. 92046185) before the TTAB, two judges held in an 81-page majority opinion that the Native American Indian petitioners had successfully shown that these six REDSKINS trademarks were disparaging to Native American Indians.

Under the Federal Trademark Act of 1946 (Lanham Act), these six trademarks were deemed to have been obtained contrary to the provisions of Section 2(a) of the statute (15 U.S.C. 1052(a)), which prohibits registration of any mark that may disparage persons or bring them into contempt or disrepute, and the TTAB ordered that the registrations be cancelled.

A dissenting opinion was filed by one of the three judges on the TTAB panel, based on that judge’s opinion that there was insufficient evidence presented by the petitioners to support the claim of disparagement by the marks. In his dissenting opinion, Judge Bergsman stated:

This case is *not* about the controversy, currently playing out in the media, over whether the term “redskins,” as the name of Washington’s professional football team, is disparaging to Native Americans *today*. The provisions of the

statute under which the Board must decide this case — §§ 2(a) and 14(3) of the Trademark Act, 15 U.S.C. §§ 1052(a) and 1064(3) — require us to answer a much narrower, legal question: whether the evidence made of record in this case establishes that the term “redskins” was disparaging to a substantial composite of Native Americans *at the time each of the challenged registrations issued*.

*See generally* *Consorzio del Prosciutto di Parma v. Parma Sausage Prods., Inc.*, 23 USPQ2d 1894, 1898-99 (TTAB 1992) (discussing the language of Lanham Act § 14(3) and explaining that the “registration was obtained” language Congress used to specify when a registration for a mark may be cancelled under the enumerated statutory provisions, such as § 2(a), “shows an intent that only if it should not have issued in the first place should a registration more than five years old be cancelled”).

In the majority opinion, the TTAB found that based on the evidence presented by the parties and on applicable law, the *Blackhorse* petitioners carried their burden of proof.

By a preponderance of the evidence, the petitioners established that the term “Redskins” was disparaging of Native Americans, when used in relation to professional football services, at the times the various registrations involved in the cancellation proceeding were issued. Thus, in accordance with applicable law, the federal registrations for the “Redskins” trademarks involved in this proceeding must be cancelled.

[MORE ►](#)

[NFL REDSKINS, FROM PAGE 9]

### EXACTLY WHAT IS A TTAB CANCELLATION PROCEEDING?

A cancellation proceeding is an action held before the TTAB in which a party seeks to cancel an existing registration of a mark. Such an action is a mini-trial conducted under specific rules of practice before the TTAB, including parts of the Federal Rules of Evidence and the Federal Rules of Civil Procedure.

Under the Trademark Act, a person (including any legal entity) who believes he will be damaged by the continuing registration of a mark may file a petition with the TTAB to cancel the registration, asserting one or more grounds for cancellation.

Most USPTO cancellation proceedings assert grounds for cancellation under Section 2 of the Trademark Act, 15 U.S.C. § 1052, which specifies a variety of types of terms or marks that Congress has determined to be ineligible for federal registration, including those that are determined, as in this case, to disparage an individual or group.

### CAN ANY REGISTERED TRADEMARK BE THE SUBJECT OF A CANCELLATION PROCEEDING?

Yes. According to federal trademark law, even a long-standing registration can be the subject of a cancellation proceeding *at any time*, if an appropriate ground for cancellation is asserted.

A claim that a registered trademark was *disparaging* of an individual or group at the time it was originally registered is one such example of a claim that can be appropriately brought at any time, regardless of the age of the registration.

### CAN THE TRADEMARK OWNER APPEAL?



Yes. A party dissatisfied with the TTAB's decision has two initial options to seek further judicial review:

- (1) One option is to file an appeal to the U.S. Court of Appeals for the Federal Circuit in Washington, D.C.; or
- (2) Another option is to file a civil action in the U.S. District Court for the Eastern District of Virginia, which has jurisdiction over civil actions seeking review of TTAB cancellation proceedings.

### ARE THE SIX REDSKINS REGISTRATIONS NOW CANCELLED?

No. This decision by the TTAB is not the final decision for these trademarks. The trademark owner, Pro Football, Inc., has now sought review by the U.S. District Court for the Eastern District of Virginia.

#### THESE SIX FEDERAL REGISTRATIONS FOR TRADEMARKS THAT INCLUDE THE TERM "REDSKINS" WERE CANCELLED IN JUNE:

1.Registration No. 836122 (1967):	2. Registration No. 978824 (1974):	3.Registration No. 986668 (1974):	4. Registration No. 987127 (1974):	5. Registration No. 1085092 (1978):	6. Registration No. 1606810 (1990):
	WASHINGTON REDSKINS			REDSKINS	REDSKINETTES

Accordingly, these six REDSKINS registrations will remain “on the federal register of marks” and not be listed in the USPTO’s records as “cancelled” until after all judicial reviews have been completed. This could include a final appeal to the U.S. Supreme Court.

### WHAT DOES THE TTAB DECISION MEAN FOR THESE TRADEMARKS?

If the cancellation of the registrations for the trademarks involved in this case is affirmed following all possible reviews in the federal courts, Pro Football, Inc., as record owner of the involved registrations, would lose the legal benefits conferred by federal registration of the marks. Such lost benefits include:

- (a) the legal presumptions of ownership and of a nationwide scope of rights in these trademarks;
- (b) the ability to use the federal registration ® symbol, and;
- (c) the ability to record the registrations with the U.S. Customs and Border Patrol Service so as to block the importation of infringing or counterfeit foreign goods.

### WHAT DOES THE TTAB DECISION NOT MEAN FOR THESE TRADEMARKS?

This decision does not require the Washington D.C. professional football team to change its name or stop using the trademarks at issue in this case.

Cancellation of the federal registration of a trademark does not mean that the owner loses all legal rights in the mark. This is because trademark rights in the United States come from use of the mark on or in conjunction with goods or services, not merely from the additional, and optional, step of federal registration.

The TTAB decision — if upheld by the federal courts — determines only whether a mark can be registered with the federal government (and

thus gain the additional legal benefits thereof), not whether it can be used.

Regardless of the federal registration status, the trademark owner retains its rights in the mark based on use of the mark. Such rights are known as “common law” rights, and those use-based rights will continue to exist even if a federal registration is cancelled.

### PRO FOOTBALL APPEALS TTAB DECISION

On August 14, 2014, Pro Football Inc., the owner of the subject Washington Redskins trademarks, filed a federal lawsuit seeking to overturn the USPTO’s cancellation of its trademark registration on grounds that the name is disparaging to Native Americans, calling the agency’s decision “replete with errors of fact and law” and additionally, unconstitutional.

The complaint, filed in the U.S. District Court for the Eastern District of Virginia, claimed that the TTAB ruling against the team violated the First and Fifth Amendments of the U.S. Constitution. It urged the court to reverse the TTAB’s decision, declare that the word “Redskins” and the team’s marks do not disparage Native Americans, and deem part of the Lanham Act unconstitutional under the First Amendment, among other remedies.

According to the complaint:

“The Redskins Marks, as designations of the professional football team, do not disparage Native Americans or bring them into contempt or disrepute under any analysis of the terms ‘disparage,’ ‘contempt,’ or ‘disrepute.’ To the contrary, the name ‘Redskins,’ when used in association with professional football — as it has been for over 80 years — **denotes only the team** and connotes the history and tradition of the club.” [MORE ►](#)

[NFL REDSKINS, FROM PAGE 11]

In the appeal, Pro Football seeks an Order of the Court regarding the following:

- (1) Reversing the TTAB Order scheduling the cancellation of the Redskins Marks;
- (2) Declaring that the word “Redskins” or derivations thereof contained in the Redskins Marks, as identifiers of the Washington, D.C. professional football team, do not consist of or comprise matter that may disparage Native Americans;
- (3) Declaring that Section 2(a) of the Lanham Act, 15 U.S.C. § 1052(a), is unconstitutional, both on its face and as applied to Pro Football by the TTAB, under the First Amendment of the U.S. Constitution, and is void for vagueness;
- (4) Declaring that the TTAB Order violates Pro Football’s rights under the Fifth Amendment of the U.S. Constitution; and
- (5) Declaring that Defendants’ petition for cancellation in the TTAB challenging the Redskins Marks under Section 2(a) was barred at the time it was brought by the doctrine of laches.

According to the Complaint, errors made by the TTAB include its failure to restrict its analysis to the relevant time frame of 1967-1990, when the registrations were first issued. As articulated by the dissent:

It is astounding that the petitioners did not submit any evidence regarding the Native American population during the relevant time frame, nor did they introduce any evidence or argument as to what comprises a substantial composite of that population thereby leaving it to the majority to make petitioners’ case have some semblance of meaning (Bergsman, A.T.J., dissenting).

## WHAT HAPPENS NOW?

This case is far from over. The petitioners now have 60 days to respond to the complaint, just as Pro Football did after the TTAB’s decision.

New evidence can be presented to the district court by both parties — and it is expected that this will be done by both sides. The district court case will proceed according to a schedule set by the court, much like the previous district court case, *Harjo v. Pro-Football Inc.*, based on another TTAB decision that cancelled several REDSKINS trademark registrations.

The reputation of the Eastern District of Virginia court as a “rocket docket” will likely mean that this case will be decided on a faster track than the previous case handled by the U.S. District Court for the District of Columbia. In 1999, the TTAB ruled that the name Washington Redskins was disparaging in the *Harjo* case but the decision was reversed on appeal because the TTAB’s finding of disparagement was not supported by substantial evidence and the suit was barred by laches.

The new venue is a result of the America Invents Act, as cases from the TTAB are now reviewed at the Eastern District of Virginia court. Will there be enough evidence this time or is the dissenting judge in the TTAB correct?

Stay tuned. ■



**Supreme Court Considers Whether  
Judge or Jury Should Tackle  
Trademark “Tacking”**

**Ross A. Dannenberg**

***Banner & Witcoff Intellectual  
Property Alert***

**December 10, 2014**



## Intellectual Property Alert: Supreme Court Considers Whether Judge or Jury Should Tackle Trademark “Tacking”

By **Ross A. Dannenberg**

December 10, 2014 – On December 3, 2014, the United States Supreme Court heard oral arguments in the case *Hana Financial, Inc. v. Hana Bank et al.*, on writ of certiorari from the United States Court of Appeals for the Ninth Circuit. This is the second of two trademark cases the Court has heard in as many days, doubling the number of trademark cases that the Court has heard over the past 10 years. At issue in the case is the trademark doctrine of “tacking,” whereby a party may “tack” the use of an older mark onto a new mark for purposes of determining priority, allowing the trademark owner to make slight modifications to a mark over time without losing priority rights.

As summarized by the respondent, superior trademark rights generally belong to the party that was first to use its mark in commerce, not necessarily the party that was first to register it. So, the “first use” or priority date of a mark is central to any infringement analysis. In the vast majority of cases, the inquiry is simple because both parties have used their marks unchanged. On some occasions, however, one of the parties may have altered its mark in response to market trends or simply to freshen up its brand image. When a mark is altered, the question arises whether the alteration resets the priority clock, or whether the trademark owner may “tack” its use of the altered mark onto its original mark to retain the benefit of its earlier priority date. The parties do not dispute the standard to determine whether tacking is permissible in any particular case—tacking is available when both marks convey to consumers a “continuing commercial impression” such that the marks are “legal equivalents” of one another. What the parties dispute is whether that determination is a question of law or a question of fact, and whether or not that determination should be made by a judge or jury.

In this case, respondent Hana Bank had adopted the mark HANA OVERSEAS KOREAN CLUB in 1994. Petitioner Hana Financial adopted the mark HANA FINANCIAL in 1995. Hana Bank switched to the mark HANA BANK some time later. Priority thus hinges on whether Hana Bank can tack its use of HANA BANK to its previous use of HANA OVERSEAS KOREAN CLUB. The district court held that the issue of whether tacking was permissible is a question of fact, and gave the issue to the jury to decide. The jury, relying largely on an advertisement that included the text “Hana Bank” alongside the mark HANA OVERSEAS KOREAN CLUB, decided that HANA OVERSEAS KOREAN CLUB and HANA BANK created a continuing commercial impression, and decided in favor of respondent Hana Bank.

Based on the oral argument, it would appear that both parties agree that the result in this case would have differed had a judge decided the issue of tacking rather than a jury, because courts have historically allowed tacking in only very narrow circumstances. The oral arguments in this case focused on the legal/equitable questions involved, and similarities to the trademark concept of likelihood of confusion (which was not lost on Justice Kennedy, referring to the “likelihood of confusion” as an “elephant in the room” during oral argument). The Justices quickly honed in on the similarities of likelihood of confusion and tacking, noting that determining a mark’s “commercial impression” is not dissimilar to the factual analysis that one undertakes when evaluating a likelihood of confusion for potential trademark infringement. And more specifically, at least in the likelihood of confusion context, that the analysis is undertaken by a jury, not a judge.

Petitioner’s arguments that decisions made by juries would be less consistent than decisions made by judges (and therefore less reliable as precedent) appeared to fall on deaf ears, as the Justices pointed out glaring inconsistencies even in previous judge-made decisions (Justice Alito stated that he could not even conceive of a way to reconcile two cases cited in the briefs, and that he would “rather blame [the inconsistency] on the jury than the court”). The Justices further noted that judges could reign in juries through the use of existing judicial tools such as properly worded jury instructions and motions for judgment as a matter of law (JMOL). Lastly, one Justice pointed out that even the *stare decisis* value of judge-made decisions is limited because each determination is heavily fact based—another reason why the decision should be left to the jury.

Reading the tea leaves, it appears to this writer that the Justices ultimately consider tacking and the “commercial impression” of a mark to be a simple concept—much simpler than patent claim construction as was at issue in the *Markman* case cited by the parties—and that it is a context-specific inquiry involving questions of fact that should be answered by a jury, not a judge. Existing judicial tools can be used to address concerns regarding consistency and the appropriate bounds of the tacking doctrine. The Court seems poised to adopt the position that a judge can set boundaries in tacking cases just as the judge would in any other civil trial matter, and leave the ultimate decision to the “panel of consumers” known as the jury.

Audio of the oral arguments is available [here](#). A transcript of the oral arguments is available [here](#).

To subscribe or unsubscribe to this Intellectual Property Advisory, please send a message to Chris Hummel at [chummel@bannerwitcoff.com](mailto:chummel@bannerwitcoff.com)



[www.bannerwitcoff.com](http://www.bannerwitcoff.com)

© Copyright 2014 Banner & Witcoff, Ltd. All Rights Reserved. The opinions expressed in this publication are for the purpose of fostering productive discussions of legal issues and do not constitute the rendering of legal counseling or other professional services. No attorney-client relationship is created, nor is there any offer to provide legal services, by the publication and distribution of this edition of IP Alert.





**Supreme Court Hears Oral  
Arguments in *B&B Hardware, Inc. v.  
Hargis Industries, Inc.***

**R. Gregory Israelsen**

***Banner & Witcoff Intellectual  
Property Alert***

**December 10, 2014**



## Intellectual Property Alert: Supreme Court Hears Oral Arguments in *B&B Hardware, Inc. v. Hargis Industries, Inc.*

By R. Gregory Israelsen

December 10, 2014 – On December 2, 2014, the Supreme Court of the United States heard oral arguments in *B&B Hardware, Inc. v. Hargis Industries, Inc.*, the first trademark case to reach the Court in nearly ten years. William F. Jay, of Washington, DC, argued on behalf of petitioner B&B Hardware. John F. Bash, Assistant to the Solicitor General, represented the United States as amicus curiae and argued in support of the petitioner. Neal K. Katyal, of Washington, DC, argued on behalf of respondent Hargis Industries.

### **Background**

Petitioner B&B Hardware, Inc., is a California business that owns the registered mark SEALTIGHT, which was registered in 1993. B&B manufactures and sells self-sealing fasteners, “all having a captive o-ring, for use in the aerospace industry.” B&B’s fasteners are designed for use in high-pressure environments and sealing applications.

Respondent Hargis Industries, Inc., is a Texas business that also manufactures and sells fasteners, albeit in the construction industry. Specifically, Hargis sells sheeting screws, which are designed to attach sheet metal to wood or steel building frames.

In 1996, Hargis applied to register the mark SEALTITE for its “self-piercing and self-drilling metal screws for use in the manufacture of metal and post-frame buildings.” The U.S. Patent and Trademark Office (USPTO) refused Hargis’s application because the SEALTITE mark “so resembles” B&B’s SEALTIGHT mark that it was “likely to cause confusion.”

In March 1997, Hargis sought cancellation of B&B’s registration before the Trademark Trial and Appeal Board. B&B opposed the cancellation and sued Hargis for trademark infringement. The cancellation proceeding was stayed pending the outcome of the litigation. In May 2000, a jury found that B&B’s mark was merely descriptive and had not acquired secondary meaning. In 2001, the Board resumed proceedings on Hargis’s cancellation petition, which it eventually dismissed in June 2003.

While the cancellation proceeding was pending, Hargis submitted supplemental materials in support of its application to register SEALTITE. The USPTO withdrew its previous refusal, approved Hargis's application, and published Hargis's mark for opposition. In February 2003, B&B filed an opposition proceeding, which began in 2006. In 2007, the Board sustained B&B's opposition and denied Hargis's registration of SEALTITE.

In 2003, B&B also filed a second infringement action, which proceeded in parallel with the opposition proceeding. In 2007, after the Board denied Hargis's application, the district court dismissed B&B's second infringement action on the ground that it was precluded by the judgment in the first infringement action. B&B appealed, and the Eighth Circuit reversed, holding that because the jury never reached the issue of likelihood of confusion in the first action, collateral estoppel did not apply.

On remand, the jury found that there was no likelihood of confusion between the two marks. B&B sought a new trial based on the district court's refusal to give preclusive effect, or even deference, to the Board's likelihood-of-confusion finding. The court denied B&B's motion. The Eighth Circuit affirmed, holding that the Board "did not decide the same likelihood-of-confusion issues presented to the district court."

B&B petitioned for certiorari, and the Supreme Court granted review on two questions:

- (1) Whether the Trademark Trial and Appeal Board's finding of a likelihood of confusion precludes respondent from relitigating that issue in infringement litigation, in which likelihood of confusion is an element; and
- (2) whether, if issue preclusion does not apply, the district court was obliged to defer to the Board's finding of a likelihood of confusion absent strong evidence to rebut it.

### **Oral Arguments**

Justice Ginsburg opened the questioning in oral arguments, pointing out that "the stakes are so much higher" in an infringement proceeding when compared to a registration proceeding. Counsel for B&B, Mr. Jay, acknowledged that the stakes are different, but argued that the inquiry is the same—specifically, likelihood of confusion. Therefore, Mr. Jay argued, the Board's "judgment is preclusive because it's deciding the same issue."

By contrast, counsel for Hargis, Mr. Katyal, argued that the question being asked is different. Specifically, the Board proceeding considers whether the resemblance of the mark is likely to confuse, whereas the district court's de novo proceeding considers whether the use of the mark is likely to confuse. The Court sought clarification on this distinction. For example, Justice Breyer referred to 15 U.S.C. § 1114—the infringement statute—which repeatedly mentions "use," including use in "advertising, sales, all different ways in which use causes confusion." Mr. Katyal explained that in a registration proceeding, the consideration is whether the resemblance

of the mark *in connection* with the goods is confusing, as opposed to an infringement proceeding, which considers *how the goods are used*—“the advertising, the marketing, the sales.”

The oral arguments included significant discussion about the evidence available in each proceeding. For example, Justice Sotomayor referenced *Kappos v. Hyatt*—in which the Court unanimously affirmed that evidence not submitted to the USPTO in patent prosecution is admissible when bringing suit against the Director of the USPTO under 35 U.S.C. § 145—to make the point that the Court has blessed the idea that an applicant does not have to submit all possible evidence to the Board for consideration. Mr. Jay explained that the applicant always has the option to appeal the Board’s decision to a district court, where the additional evidence could be presented, but if the applicant does not take that option, the “bedrock principle of the law on judgments [is] that new evidence is not enough” to avoid preclusion.

The Court also considered, however, how much evidence is actually presented in practice. Justice Breyer noted that in Board proceedings, there are no live witnesses, there is no expert testimony regarding consumer confusion, and the Board stresses “that they should not be like a district court.” Justice Kagan noted that a Board proceeding can cost only “10 percent of the cost of an infringement suit.” Mr. Katyal contrasted Hargis’s Board proceedings—where there were four depositions and no discovery—with the infringement trial, where there were 14 live witnesses and 4,000 pages of discovery.

The Justices were clearly concerned about the scope of their decision. For example, Justice Alito asked if it would be worthwhile to create a rule that applies to a very limited set of circumstances—that is, the number of cases in which the elements of issue preclusion would be met by the Board proceeding. Justice Kagan asked Mr. Jay about the proportion of parties that currently seek review by the Board instead of an alternative (e.g., infringement litigation in district court), and whether the Board is the primary avenue for resolving these types of disputes. Mr. Jay responded that Justice Kagan had asked “a difficult question,” but that “fewer than 200 Board cases go to final judgment each year in contested proceedings.”

The Justices also explored a middle ground, although neither side seemed interested in compromise. Mr. Jay said that if the Court gave deference instead of full preclusion, the deference should accord “great weight,” because the earlier proceedings were full and fair, and the issues were the same. By contrast, Mr. Katyal said that preclusion requires “an identical inquiry,” and “the procedures and the incentives at stake” must also be identical. But, Mr. Katyal continued, “that theoretical world never happens in reality.”

Understandably, the oral arguments included multiple hypothetical situations—presented by both the Justices and counsel—to aid in understanding concepts that in the abstract may be difficult to grasp. For example, Justice Breyer repeatedly referred to the same hypothetical situation in which Louis Vuitton—of designer-clothing fame—becomes involved in a trademark dispute

with the fictional Lilly Vuitton over a mark for lipstick. In another example, Mr. Katyal described a fictional mark SIKE for shoes. These hypothetical discussions presented some of the lighter moments of the arguments. For example, in discussing whether Mr. Katyal’s hypothetical SIKE shoes would have a confusing resemblance but not confusing use, Justice Kennedy lightheartedly asked, “What is the answer? . . . I need to know.”

## **Conclusion**

The Justices during oral arguments were not clearly leaning one way or another. They asked both sides difficult questions, and pushed back hard at times when they disagreed with counsel. But they also allowed all three presenters significant stretches of time to talk, which could indicate that the Justices did not completely disagree.

B&B’s argument that identical questions with identical evidence requires preclusion seemed to carry some weight. Chief Justice Roberts told Mr. Katyal that, “it seems to me you could prevail on the idea that when the [] uses are actually different it’s not precluded, but when they are [] the same, it is. That’s the basic preclusion rule.”

Conversely, Hargis’s argument—that the only time the Board is considering the same use questions as an infringement proceeding is in a “theoretical world”—may convince the Court that “the way it’s done in practice” would never fairly require preclusion anyway. Mr. Katyal drove this point home near the end of his argument by saying, “the main banana is infringement. Congress has known that. That’s the way it’s been for hundreds of years. There isn’t going to be any sidestepping of an infringement inquiry in an appropriate case. It’s going to happen.”

The opinion, which is expected to be released by April or May 2015, will affect how practitioners approach USPTO opposition and cancellation proceedings and district-court litigation.

---

Audio of the oral arguments is available [here](#). A transcript of the oral arguments is available [here](#).

To subscribe or unsubscribe to this Intellectual Property Advisory, please send a message to Chris Hummel at [chummel@bannerwitcoff.com](mailto:chummel@bannerwitcoff.com)



[www.bannerwitcoff.com](http://www.bannerwitcoff.com)

© Copyright 2014 Banner & Witcoff, Ltd. All Rights Reserved. The opinions expressed in this publication are for the purpose of fostering productive discussions of legal issues and do not constitute the rendering of legal counseling or other professional services. No attorney-client relationship is created, nor is there any offer to provide legal services, by the publication and distribution of this edition of IP Alert.

**ADDITIONAL  
PUBLISHED  
WORKS**



**Look Before You Leap ... Intellectual  
Property and Crowd-Funding**

**Robert S. Katz (Contributor)**

***Medium***

**July 15, 2014**



MauroNewMedia on Jul 15

33 min

WATCH IT  
ONCOMING  
TRAFFIC



# Look Before You Leap... Intellectual Property and Crowd- Funding

Why Major Crowd Funding Sites Couldn't Care Less  
About Protecting Your Ideas and How to Deal with  
It.

Charles L Mauro CHFP



**CL Mauro** / President / MauroNewMedia / NYC / USA

The logo for IPvCrowd Funding is displayed on a blue rectangular background. The text "IPvCrowd" is in a bold, black, sans-serif font, with a white "v" symbol between "IP" and "Crowd". Below it, the word "Funding" is written in a larger, bold, black, sans-serif font.

Recently, I was invited to speak at the Northeast Conference of the Industrial Designers Society of America on intellectual property and crowd-funding (CF). I am not a lawyer but I have consulted with some of the best around. Over the

past 35 years I have been an expert witness in over 75 major patent cases related to product design, industrial design and GUI design. That experience has taught me a great deal about how innovators deal with the realities of their intellectual property.

As an expert in support of such litigation, most of what one learns with respect to the current intellectual property system is what inventors do wrong. In fact, a primary focus of IP-related litigation is to prove or disprove the effectiveness of the IP-related processes of the opposing parties: Who did what improperly in terms of filing their patents, writing claims, preparing the design patent drawings, referencing prior art, naming inventors, claiming inventions that are obvious or not truly innovative. This effort becomes an extensive analysis whereby one examines the entire history of a given patent application, seeking problems in the filing process and the decision-making of the USPTO (United States Patent and Trademark Office) in granting the patent. □

This eventually leads to an opinion, among others, as to whether the patent is

valid and enforceable and what is the actual scope of the claimed invention. These are the knives and forks of the litigators' meal. They determine whether or not you, the inventor, end up with an innovation worth a billion dollars or pennies. Patent litigation is a blood sport. It is also a cornerstone of effective high-tech business practice. This, of course, cuts both ways as the patent holder and accused patent infringer take up positions and attempt to enforce or dismantle protections only the legal system can ultimately verify or reject.

At the end of the day, intellectual property protection is far better than the alternative: just giving away your next big thing to all takers and I can assure you there are takers. The Founding Fathers who signed the US Constitution held in very high regard the ability of inventors to have a limited monopoly on ideas they developed. Indeed, the authority for Congress to enact laws to issue patents is enshrined in the US constitution. Some have said the US patent system is a cornerstone of our commercial success in global markets. This option is yours to hold or squander. If you are considering crowd-funding your next big idea, look before you leap. Oncoming traffic can be fatal.

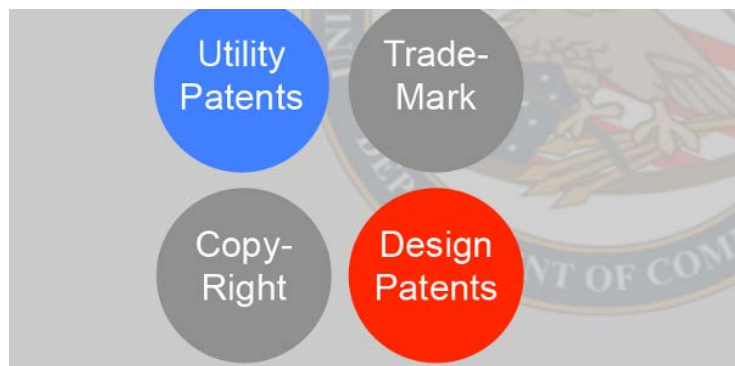

**Know Your Options** Clearly, as an innovator of confidence, you have at your disposal IP frameworks that allow you to protect almost all aspects of your next big thing. If you are about to seek crowd-funding, your understanding of what you are

giving up in the interest of speed and access to investors is not a simple issue. Below is a simplified overview of IP protections available to you, should you decide to protect your innovation before launching on a crowd-funding

platform of your choice. Note that registered IP falls under the category of exclusive rights; in other words, obtaining this kind of protection gives you the right to exclude others from infringing on your IP. One enforces exclusive rights often by litigation. First, what protections are available.

**Utility Patents:** This form of IP covers the functional aspects of the product (or service, chemical composition, method of operation, etc.) you create and is the primary vehicle for helping ensure that how your product works is protected from infringing parties. Utility patents are the most costly form of IP and require the assistance of a skilled patent attorney. They can also take the most time to create and file. If you have functional innovations that meet certain legal requirements, utility patents have high value. For in-depth information go here:

(<http://www.uspto.gov/patents/resources/types/utility.jsp>)

**Design Patents:** These cover how your product looks visually. A design patent can be directed at the overall appearance of your product or just a portion thereof. In recent years, design patents have become very important. The way your product looks is the essential means of establishing a presence in the marketplace. In a world where there is significant competition from products that have similar functional attributes, a design patent can be more important than a utility patent. Never forget that the design of your product conveys a great deal about your invention well beyond the simple visual impression. The cost of a design patent application is generally substantially less than utility patents. For in-depth information go here:

([http://www.uspto.gov/web/offices/com/iip/pdf/brochure\\_05.pdf](http://www.uspto.gov/web/offices/com/iip/pdf/brochure_05.pdf))

**Trademarks:** These cover the names and logos used to identify your innovation and your company (the source of your innovation) in the marketplace. These are not costly to file. If you fail to file trademark protections, anyone can co-opt the name of your company and even your logo

with relative impunity in any states in the US where you are not selling your product. There are certain trademark common law rights that attach to your innovation as soon as you create it, but filing for a trademark gives you additional rights. For in-depth information go here: (<http://www.uspto.gov/trademarks/>)

**Copyrights:** This type of protection covers written material related to your invention, including promotional and marketing materials, instruction manuals, photographs of your product (perhaps on your website) and related communications. Copyrights also cover artwork that is associated with your physical product but is conceptually separate (such as a label on your packaging). Copyright protection attaches as soon as you make the expressive work; you don't have to file to have rights, but filing (also known as "registering," in this context) gives you additional rights. Like trademarks, these are less costly to file for and can be critical in protecting how you describe and identify your new invention in the marketplace. Be advised that filing for a copyright registration is a prerequisite to accessing the court system for litigation. Further, failure to file for a copyright registration within 3 months of your first public disclosure of your work will result in disqualification from later seeking attorneys fees and statutory damages in the event you need to bring an infringement case. If you fail to file copyright protections, anyone can co-opt your marketing materials, web site design, package design and the like. For in-depth information go here: (<http://www.uspto.gov/main/profiles/copyright.htm>)

**Trade Dress:** This type of protection can only be obtained by having your product achieve high levels of success in the marketplace through broad exposure leading to documented high levels of consumer recognition. Because of these high standards to secure trade dress protection, it is not something to be considered in the initial stages of a new product introduction. If a product

design does reach this high level of consumer recognition, you can apply for registered trade dress (similar to applying for a registered trademark) or seek to establish such rights in court if there is an infringement of your iconic design. There are advantages to registering trade dress early, including identifying your trade dress so you can craft advertisements and a marketing message that helps in showing secondary meaning. Defending a given design via trade dress protection can only be achieved through costly and complex litigation. I mention trade dress to be comprehensive. Note that the details of trade dress protection are actually much more complex than overviewed here. For in-depth information go

here: (<http://tmep.uspto.gov/RDMS/detail/manual/TMEP/Oct2012/TMEP-1200d1e835.xml>)

**Big USPTO Changes Impact Crowd-Funding** Under recent changes in the US patent system known as the America Invents Act (AIA), you as an innovator are living in a different world than inventors that came before you. When Congress changed the US patent system in September of 2011, they tweaked a few things mostly of interest to lawyers. However, one change is vitally important to you when considering crowd-funding for your project. For in-depth information on AIA go here:

[http://www.uspto.gov/aia\\_implementation/index.jsp](http://www.uspto.gov/aia_implementation/index.jsp)

Prior to AIA, the entire US patent system was based on the idea that whoever invented something first had rightful claim to the invention. This was called “First-To-Invent.” As you can imagine, this led to no small amount of problems when an inventor filed for a patent but later found out that someone else had come up with same idea earlier. It was felt that this led to increased litigation costs for a variety of reasons including the complexity of searching and establishing who came up with a given invention first. Often whoever prevailed in the murky evidentiary battles (discovery process) prevailed in the case.

Now, under AIA, the USPTO operates under an entirely different model consistent with much of the rest of the world's IP systems. As an innovator, you are now subject to the requirement known as the "First-Inventor-To-File" system (FITF) not the old "First-To-Invent" system. The new system provides a bright line test as to who is entitled to a patent, namely, the inventor who FILED first.

### **Others May Patent Your Idea**

It may seem like an arcane and unimportant technical detail, but consider this. If you submit your next big thing on a crowd-funding site without filing for IP protection and it is very successful, anyone can



file a patent on your design under "First-Inventor-To-File." Even if they did not invent the idea, if they do file, they may end up owning your IP, and it is a difficult and costly process to prove to the USPTO that they captured your idea and were not an inventor. If you think this is far-fetched... think again.

When you put up your innovation without protection, millions of individuals have access to your product, and I can assure you that of those millions there are some number who are simply trolling for ideas to file patents on knowing that you, as an early-stage innovator, may not have the awareness or bank account to deal with such problems. This is, of course, a basic business model of some Non-Practicing Entities (NPEs) or patent trolls. Note that no one can fraudulently take your invention if they are not the inventor, but if a skilled patent troll decides to file anyway, you may be facing substantial legal fees to prove the invention is yours.

**First-Inventor-to-File Cuts Both Ways** It turns out that under the new FITF system there are sometimes strategic reasons for releasing your innovations without filing for IP protection. This comes as a surprise to those who do not understand how FITF works.

**Blocking Your Competitor From IP By Early Disclosure** A situation in which you might consider this option is when you are confident that a major competitor is going to launch an invention that is essentially the same as your invention very soon. Under this situation, it might make strategic business sense to publicly disclose your invention via a press release, by posting comprehensive information about the invention on your website, or by launching your invention on a crowd-funding site so that the formal disclosure record shows that your product predated your competitor's product. If your competitor then applied for protection under "First-Inventor-To-File" they would be subject to rejection based on your "first-to-disclose" behavior. What, exactly do I mean by this?

If you publicly disclose your invention and then the second inventor files, in legal terms your disclosure is technically "prior art." Should your competitor attempt to patent their competitive product, their application would be rejected because your design preceded theirs in the public marketplace of ideas and inventions. However, if you attempt to file later, your patent application would also be rejected because you were not the first-inventor-to-file. Understand what is happening here: This is a form of intellectual property mutually-assured destruction. You have no IP and neither does your competitor. Let's be clear: this is not the norm nor a recommendation. Your best option is to file a patent application first and require that your competitor license your IP later. Keep in mind the flip side of this situation. Even if your competitor invented a like product earlier, they have no IP rights if you also invented the same invention and filed first, before they disclosed their invention to the public. This is another example of how oncoming traffic

in crowd-funding situations is complex and can be fatal.

**The Bigger Picture** All of this clever strategic thinking is interesting but when taken from the larger perspective, most early-stage inventors who are considering crowd-funding or VC support do not understand how IP protection actually impacts the basic asset value of their ideas and eventual business success.



**Plus 20% / Minus 20%** It is surprising how few inventors, especially recent graduates of leading design and engineering programs, have even minimal understanding of how to protect their innovations. It is no coincidence that this is the same profile that is fodder for the crowd-

funding cannon. Yet the valuation of these same inventors' ideas is often determined to a significant extent by whether or not they have filed for and have obtained some measure of IP protection. VCs are famous for this method of decreasing the value of your innovations. No IP, -20% of the valuation. Rock solid IP, +20%. So the bottom line on IP is the bottom line. Of course, as with all matters legal, it is not really that simple. Some innovators create technologies that have staggering valuations and essentially no IP...think Facebook or Instagram or even the very early days of Apple. But as soon as Wall Street shows up, IP pops to the top of the list. There is an increasing trend today toward using patents as collateral for funding and financing. This is not surprising considering that IP as a percentage of shareholder value has substantially increased in recent decades. According to the Brookings Institution and Ocean Tomo, in 1978, the value of IP rights were about 20%



of overall shareholder value, whereas today the value is greater than 85%. This is another way of saying, if you want to be a billionaire, thinking in terms of robust IP cannot be ignored. However achieving this goal by crowd-funding you innovation may not get you there. The basic thinking behind CF has been around a long time.

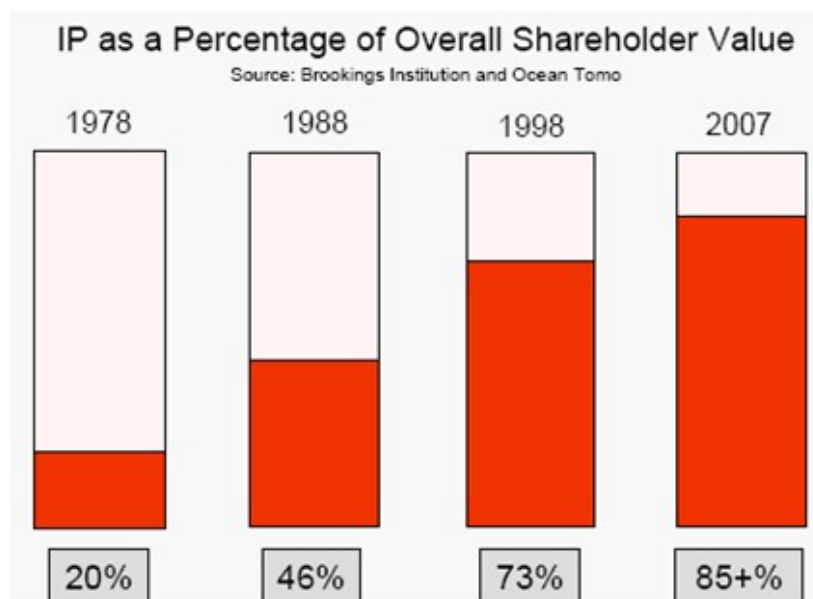

In the newly minted crowd-funding world, churn is the business model. In this model, the concept is to expose your ideas to as many potential investors as possible, get them to pony up their credit cards and when you reach your goal, take

**Pump  
+  
Dump**

their profit and dump your project. Prior to creation of the crowd-funding platforms this approach was known as “Pump and Dump,” in which mostly sketchy stockbrokers pushed high-risk investments through cold-calling methods to drive up the price of a penny stock, then dumped the stock at a

higher value and ran for the next idea. So sketchy was this process that some P&D firms ran afoul of the SEC and other legal entities. Crowd-funding is essentially the same scheme but has been repackaged in slick websites with a compelling “your-idea-can-save-the-world” brand positioning. It is hard to miss the similarities between Pump and Dump and crowd-funding. Some may disagree, but structurally they are one in the same. Without churn there is no workable business for these new funding schemes. Have no illusions; crowd-funding platforms know exactly what they are doing.

Predicting the success of your project on a major crowd-funding site has been reduced to a science. It is now possible to predict, within roughly 4 hours after you launch your innovation via CF, if it will be successful. For example researchers at Georgia Institute of Technology examined factors driving funding, creating a list of the top 100 phrases signaling that a project will or will not be funded and describing predictive principles such as reciprocity, scarcity, authority, social identity, and others. Research from École Polytechnique Fédérale de Lausanne (EPFL) and Northwestern University yielded similar sets of quantitative predictors of success and failure for campaigns based on various factors.

The science behind churn drives key aspects of the way crowd-funding sites determine how long campaigns will likely run before achieving success and who gets approved in the first place. If there is a defining variable for crowd funding, it is speed. Get in front of as many individuals with a credit card and an optimistic point of view as fast as possible. However, this need for speed comes with often poorly understood liability related to intellectual property rights and protections. Such issues can cause you no small amount of angst if not outright financial loss, but not in the ways you might imagine.

It turns out, much to the surprise of most early-stage inventors undertaking crowd-funding, that intellectual property rights and related legal frameworks

**DO NOT** go away just because churn and speed are attractive concepts for funding one's next big thing on crowd-funding platforms. Both speed and churn work against IP in ways those undertaking crowd-funding generally do not understand or appreciate. The interesting point is that such concerns cut two ways.



**Your stuff**  
**My stuff**

Pay attention here. Possibly the greatest risk to your potential success is not people stealing your ideas, but something entirely different. Your most significant risk is likely to be violation of the intellectual property of individuals

and companies who have already patented your concepts and will not be happy to see you tossing about their IP. Unless you employ some level of prior art search, you are essentially putting yourself in the way of very serious oncoming traffic. Traffic in this case means all manner of rough play by lawyers who are retained by those whose IP you may have infringed. What does this mean?

It means that if you do not employ some measure of IP defense prior to launching your crowd-funded project, chances are that you are going to find yourself with a cease-and-desist letter and a judgment against you that will make your student loan debt look like a rounding error. Such an event is probably not on your project plan or included in your Kickstarter funding model. When you put up your spiffy new gadget on Kickstarter you had better be sure that you do not violate the IP of others who have patents, copyrights or trademarks which are, in the opinion of a team of Harvard-educated lawyers, covered by another party's intellectual property rights.

This problem is not lost on crowd-funding sites and related business models. To be totally clear, crowd-funding sites couldn't care less about protecting your IP but they care a lot about not being sued by others who feel your IP violates their IP. If one takes the IP-related content posted on major crowd-funding sites as an indication of interest, it is clear that the only IP-related issue most CF sites care about is you infringing someone else's ideas. In fact, here is what major CF sites have to say about IP protections and infringement.

## **Kickstarter**

Kickstarter's *Terms of Use* exclusively addresses established copyrights being infringed upon by users of the Kickstarter service (i.e. you). Kickstarter makes no reference to IP protection or assistance for inventors and startups using the site. The site's *Getting Started* guidelines are absent of any suggestion that creators obtain copyrights, trademarks, or patents for their ideas and inventions. Kickstarter says "the easiest way to avoid copyright troubles altogether, though, is to create all the content yourself or use content that is free for public use" in order to ensure innovators avoid infringing on copyrights. (*Important note: when it comes to patents, just because you create content yourself does not mean that your idea is not infringing someone's IP*).

*Ref: [Kickstarter Terms of Use](#)*

If you have any questions about where Kickstarter stands on protecting your ideas, this statement in the FAQs will clarify: *How do I know someone won't steal my ideas?* "Being open and sharing ideas is an essential part of Kickstarter. The platform is collaborative by nature, and is a powerful community-building tool for project creators. If you are unwilling to share information about your project with potential backers then Kickstarter probably isn't for you." *Translate: We couldn't care less about others stealing your ideas; we just want to churn the projects and make a profit. If you don't*

like it, go some place else. *Ref: [Kickstarter FAQs](#)*

## **IndieGoGo**

IndieGoGo's *Terms of Use* covers issues of IP theft and infringement only in the context of infringement perpetrated by inventors who post their ideas on the site. When asked how IndieGoGo protects users from idea theft, Slava Rubin, the site's CEO, said "We're not liable for any of that stuff."

*Ref: [IndieGoGo Terms of Use](#)*

*Ref: [How to Find Funding | Raise Money](#)*

## **GoFundMe**

Like Kickstarter and IndieGogo, GoFundMe only addresses established copyrights being infringed by inventors using the site, not vice versa, and provides no IP protection or information on obtaining patents or trademarks for innovators.

*Ref: [GoFundMe Terms and Conditions](#)*

## **RocketHub**

As with its counterparts, RocketHub only addresses established copyrights being infringed upon by users of the site, not vice versa.

*Ref: [RocketHub User Agreement](#)*

## **KarmaKrowd**

At present, the only crowdfunding site which addresses the issue of IP protection is recent start-up, KarmaKrowd, created and run by intellectual property attorney Cindy Summerfield, and her partner, fellow patent attorney, Patrick Richards. Unlike its counterparts, KarmaKrowd assists innovators with patents, copyrights, and trademarks before launching their ideas and inventions on the site. *(Important note: We do not endorse this site but mention it here as a reference)*

*Ref: KarmaKrowd*

# Road Map 1.2.3

**What Happens When?** What happens if a crowd-funding site receives an IP complaint against your project? The answer is simple. You and your project are toast and dealing with the violation is your problem, not the crowd-funding site's. If you have any doubt, read

the T&C you will be required to sign before putting up your project for funding. Crowd-funding is a two-way street when it comes to IP-related matters. Not understanding this can lead to a very unpleasant outcome. All of this leads to the obvious question: how should one go about dealing with IP-related matters before disclosing ideas to the crowd-funding machine? The rules of the road are not obvious but workable if one understands the underlying issues. Here are 4 steps to consider.

## 1 STOP

**Rule Number One** Stop and think before you toss up your project for crowd-funding without concern for protecting the ideas you have. This is not easy to do when caught up in the brand messaging of crowd-funding sites

and the general excitement to get your stuff in front of others with the hope of gaining positive feedback and funding. If you post up your ideas on a crowd-funding site without IP protections in place, two things happen.

**Your Protections are Done For** In most countries of the world except the US, your patent protections are toast. Yup, done for. When you disclose your

invention to the public without first filing a patent application, you give up your right to secure patent rights. You might not think of this as a big deal but today the vast majority of those who copy products are **not** US companies. For example, giving up patent rights in China may not be a good choice. This leads to the obvious question of what constitutes disclosure. My colleagues at leading law firms agree that there is no hard-and-fast definition, but for sure putting up your idea on a CF site is big-time disclosure. If you posted up your idea on a blog, gave a presentation at a conference, showed it at a trade show, participated in a pitch demo series, posted it on a portfolio site... these are all public disclosure.

**Timing is Everything** If you are going to be in the business of building an amazing future from your ideas, just know that timing is everything when it comes to IP. I can assure you, as one who has participated in major IP infringement cases, the first thing opposing counsel will look at is *when* you first disclosed your idea. If the litigation is years later, you may not remember when you first disclosed your product. I have seen several hundred million dollars in royalty payments lost as the result of an inventor not understanding and keeping track of when they first disclosed an idea. Keep track of when, where and how you show your stuff to the public.



**The Big Clock In The Sky** If you disclose your idea without first filing for patent protection in the US you have a bit more flexibility than in most other countries, but the important idea is that in the US when you disclose, a giant clock

starts ticking. From the date you disclose your invention, you have one year to file either a patent or a provisional patent application (note that a provisional

can only be filed for a utility patent). If you file a provisional (actually a misnomer) you must file the formal patent application within one year thereafter. So simply put, if you disclose you have at most two years to file for IP protection. This is not nearly as good as it sounds. The so-called provisional patent application must cover all the same subject matter as the final patent application. Therefore, the cost and time involved is essentially equal. Keep in mind that a competitor who invented the same thing first could always come forward during this process with evidence that they were first-to-disclose, which will invalidate your patent applications unless you can prove otherwise. A big waste of money. Because a provisional patent needs to be just as comprehensive as a non-provisional patent, many attorneys recommend against filing a provisional patent except in some special circumstances. (*Note: For more information about disclosure grace periods in various countries, [click here.](#)*)

**Provisional Patents Are Not Provisional** If you toss a weak provisional patent at the USPTO you are making your life a lot more difficult down the road when you file a formal patent application. You also make your life much more difficult if you are granted a patent and then litigate against an infringer. If that happens the entire history of your filing is open to review by opposing counsel. Aspects of your provisional patent filing that you would never think would be a problem can and do become fodder for opposing counsel sometimes with devastating outcomes. If you changed your ideas significantly during the process, all manner of complications can and will ensue. Indeed, you will only be afforded the earlier provisional application filing date if the substance of that application matches the substance of the formal patent application. In other words, if you file a provisional application containing half-baked ideas, you will only be entitled to the earlier provisional filing date for those half-baked ideas, not your finalized ideas that you included in the later filed formal patent application.





## **2THINK IP Y/N**

**Really, How Good Is Your Idea?** The surprising aspect of IP that is often overlooked by early-stage inventors and entrepreneurs of all stripes is the question of whether or not they actually have an innovation that is worthy of IP

protection in the first place. It often comes as a major surprise to innovators who retain a patent attorney to review their invention for possible IP protection that almost everything they believe is wildly innovative and unique has been invented and protected before by someone else.

Keep in mind that your idea cannot be protected if there is any form of a publicly disclosed prior solution that, in the opinion of a USPTO Examiner, renders your application unpatentable. This process is a major eye-opener for most early-stage inventors. I have seen many highly talented engineers, designers, inventors walk into an attorney's office with 100 patentable features and walk out with nothing more than a recommendation to file for trademark protection on the new company's logo. To be clear I have also seen the opposite. This is another way of saying: do not fuss over what you think is protectable unless you get the opinion of a expert. There are very few truly new ideas.

If you find that your next big thing was invented 10 years ago, then you might consider not tossing it up on Kickstarter. Just remember that those who invented the same idea may well send you a cease-and-desist letter followed by all manner of time-consuming legal complaints and eventual litigation. Do not even **THINK ABOUT** the approach of launching on Kickstarter first and

begging for forgiveness later. I can assure you, forgiveness only comes with forfeiture of some measure of your operating capital, which is not where you want to be when creating the next big thing.

All of this is another way of saying that it is a mistake to think that, when you launch on a crowd-funding site, you are doing anything less than launching a potential business with all the upside potential benefits and downside risks. In fact, compared to VC funding (which most often operates under the cloak of confidentiality), by crowd-funding your innovation (which is completely open to the public), you are dramatically increasing your risks related to IP loss or infringement of others' IP. In this regard, before you toss your great invention into oncoming traffic you should consider taking both a defensive and offensive IP strategy. Here is what I mean.

**Think Defensive IP Strategy Before Disclosure** You and your colleagues should conduct a search for related products in the marketplace and identify any that appear to have similar features, functions, appearances, names and copyrighted material. The more in-depth the search, the less risk you will have of being sued by those who already have IP on your innovation or even a component of your innovation. If you come across products which have similar features or appearances, pull their patents from [USPTO.gov](http://USPTO.gov) or Google Patents and review for similarities and violations. Surprisingly, this is not as hard as it sounds at the basic level and you can use this same material in your offensive IP strategy.

**The Art of Patent Search** A word of warning on patent searches. The [USPTO.gov](http://USPTO.gov) patent search section of the main website is famously difficult to understand and can be off-putting in the



extreme. Usability is not a high priority for USPTO web design.

However, the USPTO is the final word on filed applications and issued patents. Google Patents is easier to use and applies a different search algorithm, so it can be helpful to use in addition the USPTO patent search.

When searching [USPTO.gov](http://USPTO.gov) for patents, always look beyond any competitive product's patents and conduct a series of broader searches by product category, topic category, and/or names of pioneering inventors in your field. However, another word of warning from someone who has searched for patents before the Internet existed (not a fun way to spend your time). Even today with most filed patents available online, the USPTO does not always have patents properly classified by product category, and entire categories of products can be missing. The most famous current example is that the USPTO does not have categories for "Robots" or "Smart Watches." If you want to search for conflicts for a new robotic technology or robot design you have to search other product categories and hope you hit on relevant prior art. On the other hand, when time is of the essence, in many cases patent attorneys will recommend that you file the patent application and forgo patentability studies. All this aside, you will not be excused if you accidentally or innocently failed to locate a relevant prior patent. The ball is in your court, it is your problem. This is why there is a large and very profitable industry that does nothing but search for patents and prior art for law firms and corporations when filing and litigating patents. Prior art search is big business but it is also your business if you want to avoid legal problems.

**Do Not Tease the Big Animals** If your idea appears to be present in a leading high-tech company's products and that company is known for aggressive patent enforcement, DO NOT launch on a crowd-funding platform without consulting a patent attorney. It is far better to pay an attorney to determine your risk before launching a product than to pay them to defend you later on. Furthermore, those brave souls who ante-up their credit cards in crowd-funding programs look askance at their money going to support litigation versus creating a product.

**Think Offensive IP Strategy Before Disclosure** Using the same material gathered in conducting your defensive strategy, identify areas of IP where there are major gaps or unprotected innovations. It has always been interesting how much one can learn from examination of patents issued for competitive products or other products which are in some way related to one's invention. This is especially important when searching the patents or related IP of a competitor for possible conflicts. It is surprising what companies protect and FAIL to protect. This information can be a major source of innovation for your next big thing. How you make use of this material is up to you. Offensive use of IP filings is well understood by corporations and inventors large and small. Take advantage of this resource pool before you crowd-fund your innovation. You may end up with a far more valuable solution that you thought possible.

**Think No IP Before Disclosure** This is the point covered earlier whereby you disclose your invention without filing for any product-related IP simply to keep a major competitor from securing IP protection as well. Keep in mind that if you adopt this strategy, you will not be able to secure IP in most other countries of the world and that you are likely to see competitors spring up who you will have no impact on in terms of IP protections. Undertake this strategy with caution and counsel.

**Consider VC Funding** This is the old-world way. It is a fact that obtaining VC funding is vastly more complex and time consuming than crowd-funding. There is a reason for this. VC funding has certain advantages that make it worth



considering. This assumes you have an innovation of suitable scale and with meaningful IP already in place or planned for. Here is a basic comparison between crowd-funding and venture capital funding. The differences may surprise you.

**Big Numbers** In crowd-funded projects, a massive number of individuals see your work instantly as opposed to a very small group of pain-in-the-ass recent MBAs who have a vested interest in keeping your stuff confidential. As I have said before, the CF platforms, regardless of their warm and fuzzy brand positioning and save-the-world attitude, couldn't care less about whether or not you are protecting your ideas. They care only about churn: more projects, funded faster and at higher funding levels. This drives the valuations of their business and related compensation.

**Not Your Friends** Many of the individuals who view your project on a CF platform will not have your best interest in mind. This group includes a surprisingly large number of individuals and corporations trolling for new ideas to copy and NPEs, also known as patent trolls, scanning for any possible indication that your clever new thing infringes patents in their portfolio. This problem is not going away anytime soon as Congress failed this past session to enact protections related to the abusive practices of NPEs. If you are set upon by an NPE, a responsible VC firm is generally well-equipped to respond with appropriate (\$600 per hour) legal resources. These costs, by the way,

come out of your equity profile. If you crowd-fund your idea without IP in place you may well experience, with startling rapidity, your next big thing reproduced exactly as designed on Alibaba or Amazon. Neither of these e-com behemoths care a wit about protecting your next big thing.

**Churn and Burn** As I have said before, crowd-funding sites directly ignore IP protection for your ideas for a very real business reason. In fact the last thing CF sites want is for you to take the time to work out a viable IP strategy before disclosing your next big thing. Careful planning related to your IP is not conducive to high levels of churn.

On the other hand, the entire concept of VC funding is based on a highly controlled version of churn and burn but in reverse. VCs burn before they churn. By this I mean that they reject a massive percentage of ideas (burn) and flip companies at all stages of development for a profit (churn). As a result, VC funding is by its very nature brutally honest and not warm and fuzzy in the least. However, generally you know where someone who is putting a lot of his or her money into your product thinks you will end up.

All VCs are interested in your IP and will want you to make the right decisions related to protections and filings. It is their money in your idea and protection is a primary objective. As noted above, VCs factor IP directly into the asset value of your innovation. Without IP, you are going to have a rough road with VC funding just as you will with CF.

Even though I will receive a ton of negative comments about this, my experience strongly suggests that once you have conducted significant research and have formulated an IP strategy and

# **3 GO PLAN A/B**

**BEFORE** you post up on a crowd-funding platform, pay the fee and meet with an experienced patent attorney. Over a long, successful career as an expert witness working many hours on difficult cases with leading patent attorneys, I have found them to be an exceptionally positive and engaging bunch. Most patent attorneys have undergraduate degrees in engineering, design or a related science. Many have worked in these professions before transitioning to patent law. It is my experience that they love innovation and design as much as you do. Yes, they make a good living but in the end that is your goal as well or you would not be inventing things of potential value to others. Based on my experience, here is a list of 10 factors to consider when seeking legal assistance before crowd-funding your next big thing. These are not in priority order.

- 1. Never go to your family's lawyer for IP recommendations. They may have had a course in patent law 30 years ago, and yes, they are going to be cheerful and positive, but they are not going to be helpful. Forget friendly, go for experienced, even if Mom and Dad agree to pay the bill for the family lawyer.**
- 2. Before the initial meeting with a patent attorney make it clear that you are considering launching your product on a major crowd-funding platform and that you need their opinion on how to proceed. Confirm that they have a working understanding of crowd-funding and related issues.**
- 3. Never go see a lawyer who does not practice patent law covering your specific type of invention or product category. If you're seeking guidance on patenting a new GUI design, do not consult with a patent lawyer who**

**does automobile utility patents.**

- 4. Always get a reference from a previous client who is an early-stage inventor like yourself. If a lawyer has not dealt with your type of problem and related budgets, they are going to cause you no small amount of anxiety over costs and schedules.**
- 5. Do not automatically write off a bigger IP firm. Lawyers need to nourish new clients just like the rest of us. Sometimes, IP-focused, established law firms with good reputations have options for taking on a limited number of start-up clients. No harm in asking. If your college roommate's mother or father is a partner in the patent law practice of BigLawFirm, go for it. Get a meeting any way you can.**
- 6. Do not visit a patent lawyer without having already done your homework in terms of defensive and offensive research. You should also have a very clearly defined version of your idea in nearly complete form or in a form that describes exactly what you intend to crowd-fund and produce.**
- 7. Be prepared with a formal written list of features and functions which you believe are truly innovative and patentable. This should be in a numbered list with a description of what the feature does and why you think it is unique and patentable. At the top of the page before the list is a simple description (one paragraph) of your big idea and why it is innovative.**
- 8. If your product has a specific visual appearance, make sure you have a model or drawings of how it will appear to the consumer. The more detail you have, the better. Design patent protection is an absolutely critical IP protection with very high value in an increasingly complex world.**
- 9. Bring a copy of your company name and logo and your product name and logo.**
- 10. Money invested in a quality patent application pays off. Before you visit an**



attorney, confirm their billing policy, rates and whether or not they will be billing you for the initial consultation. If they are billing you for the initial consultation, do not take that as a negative sign. Pay the freight and get their opinions. As a new client, you should expect to pay a retainer based on the scope of the work expected to be done. Do not leave without a clearly defined next step.

**In The End** Crowd-funding is a new phenomena made possible by loosening governmental controls on how we invest in companies combined with web-based delivery of ideas in a compelling and easy to access format. The current crop of crowd-funding platforms can be thought of as the early days of a totally new form of capital formation which will hopefully lead to new funding models for early-stage companies. Like bankers in the Wild West, they tend to run fast and loose with formal procedures and have minimal regard for the little guy. This will change.

**The Old and the New World** It is a fact that the current IP systems (on a global basis) were not designed for such a fast moving and broadly distributed presentation of new ideas and funding models. In this regard, IP systems are as outdated as the crowd-funding platforms are advanced. This does not remove from either process the requirement to nourish an ecosystem in which protection of intellectual property can be respected and maintained.

***Charles L Mauro CHFP***

### **About the Author**

Charles L Mauro is President of MauroNewMedia, a New York-based consulting firm founded in 1975 specializing in professional usability engineering and man-machine systems design. He has received awards and

citations from the Human Factors and Ergonomics Society, Association of Computing Machines, NASA, and others.

He has lectured on UI/UX design and usability engineering at MIT, Stanford University, UC Berkeley, UPenn and many other leading educational institutions. Mr. Mauro has been retained as an expert witness in over 75 major cases representing leading high technology companies covering GUI and product design patent litigation. He has given presentations at USPTO Design Day and is founder of the USPTO Examiners Afternoon, a yearly event which brings together USPTO patent examiners with leading design experts and attorneys. He is currently Chairman of the Industrial Design Society of America (IDSA) Design Protection Section.

## **Connecting with the author**

[Twitter @PulseUX](#)

[Charles L. Mauro CHFP LinkedIn](#)

## [PulseUX Blog](#)

PulseUX provides the professional fields of user experience research and design with a voice for critical analysis and commentary. We strive to create an active and articulate view on matters of the interface between man and machine.

[MauroNewMedia: Case Studies \(66 Projects\) page](#)

## **Other popular long-form articles by Charles L Mauro CHFP**

[Apple v. Samsung: Impact and Implications for Product Design, User Interface Design \(UX\), Software Development and the Future of High-](#)

[Technology Consumer Products \(1 million + views\)](#)

[Milestones and Missteps UX/UIUX Design Review for 2013: Winners and Losers... Not the Usual Suspects \(500K + views\)](#)

[Why Angry Birds is So Successful and Popular: A Cognitive Tear Down of the User Experience \(3 million + views\)](#)

[User-Centered Design in the New World of Complex Design Problems](#)

[User Interface Design and UX Design: 75 Important Research Papers Covering Peer-Reviewed and Informal Studies](#)

[Recent interview on Bloomberg TV: Why Games Like Candy Crush are So Addicting \(King World IPO Analysis\)](#)

## **IP related resources**

[USPTO.Gov](#)

The United States Patent and Trademark Office (USPTO) is the federal agency for granting U.S. patents and registering trademarks. Their mission is to provide high quality and timely examination of patent and trademark applications, guide domestic and international intellectual property policy, and deliver intellectual property information and education worldwide.

[Google Patents](#)

Google search engine that indexes patents and patent applications from the United States Patent and Trademark Office (USPTO).

## **Blogs related to IP matters**

## Patently-O

A patent law blog run by American patent attorney, Dennis Crouch, which features analysis on current Federal Circuit law and other subjects. Cited by BusinessWeek as being the most widely read blog on patent law.

## Foss Patents

A blog run by award winning intellectual property activist-turned-analyst Florian Mueller, which covers software patent news and issues with a particular focus on wireless, mobile devices.

## **Special Interest Groups Related to IP Matters**

[IDSA Design Protection Section LinkedIn](#) (membership by request)

## **Resources and other points of view on crowd-funding and IP**

[Using crowdfunding sites could destroy your nascent business idea](#)

[Technology: Caution before you crowdfund!](#)

[How to protect your ideas on crowdfunding sites](#)

[Crowdfunding with a twist: Intellectual property work comes with fundraising at this startup](#)

---

## **Reviewers and Contributors**

I would like to thank the following leading IP attorneys who have reviewed this article and provided valuable and insightful clarifications. They are all terrific IP lawyers. I know from first hand experience.

*Elizabeth D. Ferrill* is an attorney at Finnegan LLP in Washington, DC. Ms. Ferrill focuses her practice on all aspects of design patents, including prosecution, counseling, and litigation. She also has extensive experience in utility patent litigation in the areas of computer-related technologies. Ms. Ferrill holds undergraduate degree in Computer Science from the U.S. Air Force Academy, a graduate degree in Computer Science from Georgia Tech, and a JD from University of North Carolina at Chapel Hill.

<http://www.finnegan.com/elizabethferrill/>. This article is for informational purposes, is not intended to constitute legal advice. This article is only the opinion of the author and is not attributable to Finnegan LLP, or the firm's clients.

*Christopher Carani* is a partner at the intellectual property law firm of McAndrews, Held & Malloy, where his practice centers on protecting and enforcing design rights. Chris formerly chaired the American Bar Association's Design Rights Committee, and also the American Intellectual Property Law Association's Committee on Industrial Designs. Chris counsels clients on strategic design protection and enforcement issues; he is often called upon to render infringement, validity and design-around opinions and serve as a legal consultant/expert in design law cases. Carani has works with clients, both Fortune 100 companies and individual designers, to secure a wide array of design rights both in the U.S and outside of the U.S. Chris received his J.D. from The University of Chicago and his B.S. in Engineering from Marquette University. Away from the law, Chris is a studied jazz musician playing upright bass on the Chicago jazz circuit. He can be reached at [ccarani@mcandrews-ip.com](mailto:ccarani@mcandrews-ip.com). <http://www.mcandrews-ip.com/profile/ccarani>

***Robert S. Katz*** is a partner in the Washington D.C. office of the intellectual property law firm Banner & Witcoff and has benefited firm clients in the areas of utility patents and industrial designs. Both nationally and internationally, Mr. Katz is considered as a premier practitioner in the field of industrial designs. He has helped procure more than 5,000 design patents in the U.S. and more than 15,000 design patents/registrations outside the U.S. He has also helped to successfully enforce more than 100 design patents. He is a former USPTO Utility Patent Examiner and has a Mechanical Engineering degree from Carnegie-Mellon and a J.D. from George Washington University School of Law. He is a professor at George Washington University School of Law teaching Design Law and a professor at Georgetown University Law School teaching Intellectual Property Pretrial Litigation Skills.

[www.bannerwitcoff.com/rkatz](http://www.bannerwitcoff.com/rkatz).

Also thanks to my research associate Emily Fisher who ran down the references, added content and coordinated all reviewers.

***Emily Fisher*** is a design research associate at MauroNewMedia, where her roles include research, prototyping, and project management for a variety of design and usability projects. In addition to job functions related to mechanical design, interface design, and usability testing and analysis, she also works in support of complex litigation. She holds a Bachelor's Degree in Mechanical Engineering and Applied Mechanics from the University of Pennsylvania, as well as a Master's Degree in Integrated Product Design, also from the University of Pennsylvania.

Recommend

Suggest a link

---

WRITTEN BY



## MauroNewMedia

Founded 1975 MauroNewMedia's twitter version of the firm's award-winning blog, PulseUX, providing insights into complex man-machine systems research and design.

[Follow](#)

---

Thanks to: Beth Ferrill,

Cover photo: Charles L Mauro CHFP

The Medium logo, consisting of the word "Medium" in a white, sans-serif font, centered on a dark blue background with a blurred landscape image.

The stories that matter to you, written and recommended by the people you know.

[Join Medium](#)

[Sign in](#) [How do I write?](#) [About Medium](#) [Find something to read](#)

# **WEBINARS**





**Hey, That's My Game: Intellectual  
Property Issues in Combating Game  
Cloning**

**Ross A. Dannenberg**

***American Bar Association Center for  
Professional Development***

**May 8, 2014**

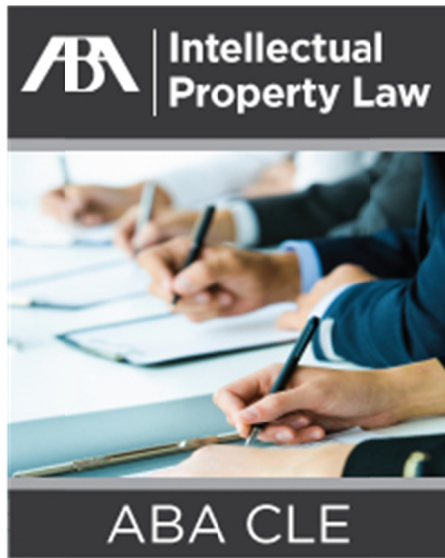

## **Hey, That's My Game: Intellectual Property Issues in Combating Game Cloning**

Game cloning has long been an issue of concern for game publishers, but with the blockbuster growth of social and mobile games, these claims have increased exponentially. This program will present the intellectual property concepts at play in such game cloning suits, review best practices for defending against such claims, and discuss how to create games without generating a claim.

Speaker(s):

[Chrissie Scelsi](#)

[Ross Alan Dannenberg](#)

Sponsor(s):

[Center for Professional Development](#)

[Section of Intellectual Property Law](#)

Recording date: May 08, 2014

Product code: CET14HTGCDR

Credits:

1.50 General CLE Credit Hours

# **MEDIA MENTIONS**



***Bloomberg***

# Bloomberg

## Why Would Anyone Want Fisker? In a Word: Patents

By Angela Greiling Keane and Susan Decker - Feb 6, 2014

Two Chinese-backed companies are locked in a bidding war, culminating next week, to take over bankrupt U.S. carmaker Fisker Automotive Holdings Inc.

The prize is a dozen-and-a-half patents and a possible toehold in U.S. and Chinese markets. The rest is a harder sell.

Fisker hasn't made a vehicle since 2012. Its \$103,000 plug-in hybrid sports sedan, the Karma, was called a "basket case" by Consumer Reports. The company, which lost \$139 million in U.S. taxpayer money, was labeled a "loser" by Republican [Mitt Romney](#) during 2012 U.S. presidential debates. Its most visible asset is a derelict former General Motors factory that Fisker never used.

China's Wanxiang Group emerged in December as a suitor for Fisker, challenging Hybrid Tech Holdings LLC, a Chinese-backed firm that had been jockeying to take over the bankrupt automaker. The rivals' interest prompted a bankruptcy judge to set a Feb. 12 auction for Fisker's assets.

"It's not about the manufacturing," said Steven Szakaly, the National Automobile Dealers Association's chief economist. "It's about the intellectual property."

Fisker's 18 patents cover grille designs, a fender vent and electric-vehicle drivetrain technology, according to the [database](#) of the U.S. Patent and Trademark Office. **It also has at least 18 more patent applications pending, including in aluminum subframing and solar-car technologies, said Charles Shifley, a patent attorney at Banner & Witcoff Ltd. in [Chicago](#).**

### Jump Start

The patents have many potential applications for buyers eager to break into the growing alternative-fuels market, said Blair Jacobs, a patent lawyer with [McDermott Will & Emery](#) in Washington.

"To have a jump start with a portfolio that took three to five years to develop is really substantial," said Jacobs, who has represented automakers in past disputes.

For a Chinese suitor, the Fisker package holds particular promise. The assets would let the buyer revive the Fisker brand in the world's biggest auto market, which is struggling to reduce some of the globe's worst air pollution. It would also provide an entry point to selling cars in the U.S.

The battle for Fisker pits Hybrid Tech -- led by [Richard Li](#), the son of [Hong Kong's](#) richest man, [Li Ka-shing](#) -- against Wanxiang, China's largest auto-parts supplier.

Wanxiang is owner of B456 Systems Inc., the successor to A123 Systems Inc., the U.S. company that supplied batteries to Fisker until collapsing under the cost of recalling defective Karma power packs. It would make sense for Wanxiang to buy Fisker after acquiring the battery-maker, said Shifley.

## Bieber, DiCaprio

The Karma was designed by [Henrik Fisker](#), who won plaudits for his work on cars for Bayerische Motoren Werke AG and Ford Motor Co.'s [Aston Martin](#). Karma drivers included singer Justin Bieber and actor [Leonardo DiCaprio](#).

Fisker was an early partner of [Tesla Motors Inc. \(TSLA\)](#), which accused it of stealing technology and designs intended for what became the Tesla Model S. Fisker prevailed.

With the car still in the design stages, Fisker in 2009 won the largest loan commitment to a startup company from a U.S. Energy Department program to develop alternative-fuel vehicles. Most of the \$529 million was predicated on Fisker manufacturing cars in the U.S.

That didn't happen. Fisker failed to meet production milestones for the Karma, which was made in [Finland](#). The Energy Department froze the loan after distributing \$193 million.

## Curb Appeal

For all its low-slung curb appeal, the Karma was plagued by technical flaws. [Consumer Reports](#) said its review model broke down after going less than 200 miles. The cars were recalled three times for battery and cooling-fan defects before A123 stopped production.

Last April, after firing most of its workers, Fisker defaulted on the U.S. loan without making a payment.

Li's Hybrid Tech last year paid the Energy Department \$25 million -- about 15 percent of the balance -- to assume ownership of the loan, putting Hybrid in a favorable position to take over Fisker's remains. The department sold the loan to salvage what it could from the money Fisker had drawn down.

Fisker filed for [bankruptcy protection](#) in November under an arrangement calling for the group led by Li to trade its ownership of the loan for the automaker's assets.

That plan was derailed in December, when Wanxiang told the court it wanted to bid.

Hybrid's latest bid was \$55 million, including the \$25 million it invested in the U.S. loan. Wanxiang has offered \$35.8 million in cash, up \$10 million from its first offer.

## Wilmington Watching

The duel is being watched in Wilmington, [Delaware](#), where Fisker spent \$20 million in 2010 to buy the abandoned GM plant. The plan was to retrofit it to build a second model, to be called the Atlantic, with production targets as high as 100,000 cars a year. Delaware taxpayers are footing the electricity bill for the plant until its future is decided.

Hybrid Tech, as a condition of acquiring the Fisker loan, is required to manufacture in the U.S. Wanxiang isn't bound by that agreement, though Energy Secretary Ernest Moniz said that "terms of our loan have to be respected."

"We have technology transfer limitations," Moniz told reporters Jan. 22 at the [Washington](#) Auto Show. "No matter who the winner is, we will be looking at both engineering and manufacturing in the U.S. That's the key for us."

Both companies say they're interested in using the U.S. plant.

Wanxiang America Corp. President Pin Ni declined to comment while pointing to court filings that describe the closely held company's plans.

## New Karma

Wanxiang "can immediately restart the production of the Karma sedan and provide parts and service to the existing owners," the company said in a Jan. 8 filing. "Wanxiang intends to continue development of the Gen II line of cars and, once they are ready to be produced in large quantities, would build them at Fisker's plant in Delaware."

Hybrid deepened its commitment on Jan. 24 by lending Fisker \$13.1 million to cover its expenses.

"Together with our partners, investors, designers and suppliers, Hybrid is working to achieve a rapid re-launch of the Karma and the forthcoming Atlantic plug-in sedans," Megan Grant, a Hybrid spokeswoman, said in an e-mail. "We look forward to the acquisition of the company and a path forward for the Delaware plant."

## China's Promise

Investors see hope for electric cars through Tesla's success and [China's](#) subsidies for electric-vehicle purchases.

Tesla co-founder Elon Musk said in January that China may become the company's biggest market. Electric-vehicle sales in China may increase 19 percent by 2015 and 27 percent by 2020, according to an October report by Bloomberg New Energy Finance.

No Chinese-made car has been certified by U.S. regulators to be sold in the U.S. Chinese investors bought Swedish carmaker Volvo Car Corp., which sells vehicles in the U.S., and Chinese companies have automaking partnerships with companies including Daimler AG and Hyundai Motor Co.

"In terms of the Chinese, they're clearly trying to get into the U.S. markets," Lacey Plache, chief economist for auto-researcher Edmunds.com, said in an interview. "If they could get something that totally disassociates them from the Chinese car, that's a good thing."

Still, Plache said, Fisker is a little-known brand in a niche auto technology. "They're taking a bet on EVs being a stable market in the U.S. and that's an iffy thing," she said. "It's not clear to me that Fisker has enough cachet to bring it back."

To contact the reporters on this story: Angela Greiling Keane in Washington at [agreilingkea@bloomberg.net](mailto:agreilingkea@bloomberg.net); Susan Decker in Washington at [sdecker1@bloomberg.net](mailto:sdecker1@bloomberg.net)

To contact the editors responsible for this story: Bernard Kohn at [bkohn2@bloomberg.net](mailto:bkohn2@bloomberg.net); Jeffrey D Grocott at [jgrocott2@bloomberg.net](mailto:jgrocott2@bloomberg.net)

©2014 BLOOMBERG L.P. ALL RIGHTS RESERVED.





## INVENTOR WHO SHOCKED TECH WORLD STUMPED BY 43-YEAR PATENT DELAY

Bloomberg Exclusive  
Feb 24 2014 00:00:01

By Susan Decker and Ian King

Feb. 24 (Bloomberg) -- Forty-three years is too long even for Gilbert P. Hyatt, the dogged inventor who once shocked the computer industry and got rich.

Hyatt said he's been waiting that long for a U.S. ruling on whether his electronic signal to control machinery should be granted a patent. The patent-approval process takes 28.3 months on average. His idea for liquid crystal displays? That's been sitting in the Patent and Trademark Office for 35 years.

The Las Vegas-based inventor, who turns 76 in March, filed a **lawsuit** in January demanding action on what may be the oldest pending U.S. patent applications. Hyatt attributes some of the delay to retribution for sometimes making the agency look bad during years of disputes.

"It's totally unconscionable," said **Brad Wright**, a patent lawyer with **Banner & Witcoff** in Washington who specializes in computer-related applications and isn't involved in Hyatt's case. "The patent office doesn't want to be embarrassed that they might issue a broad patent that would have a sweeping impact on the technology sector. Rather than be embarrassed, they're just bottling it up."

No one is able to put a price tag on what licensing those two patents would cost technology companies. Even Hyatt said he's not sure whether he would replicate the shock of getting a patent in 1990 on a "single chip integrated circuit computer architecture," a ruling that effectively gave him a financial claim to most microprocessors, the digital backbone of every personal computer in the world.

### Industry Firestorm

What is certain is that Hyatt isn't some gadfly in a garden shed. He's probably made more than \$150 million from a deal with **Royal Philips NV**, the Dutch electronics maker, to license 23 of his **patents**, including the 1990 one. Intel Corp. co-founder **Robert Noyce** invested in Hyatt's first company in the 1960s, according to Hyatt.

"These were fundamental technologies and even though the industry has grown tremendously, they are based on those fundamental technologies," Hyatt, who still works in his private lab each day, said in a telephone interview. "I suspect that my ideas are still novel, even to this day."

The patent office, which issued 302,948 patents last year and receives more than 500,000 new requests annually, won't say what's in Hyatt's two pending applications.

Because the filings are so old, they fall under a law that keeps them confidential, said Patrick Ross, a PTO spokesman. That means the office can't discuss them or even say how many pending patent applications predate a 1995 change in the law, Ross said.

All Hyatt would say is that he is fighting to get acknowledgment for his work on what he calls "square wave machine control."

### Texas Instruments

It took Hyatt 20 years to get his 1990 microprocessor patent. He filed the application around the same period as the two still pending.

Reaction at the time was swift. Texas Instruments, the world's largest analog-chip maker, argued to the patent office that Hyatt was claiming credit for one of the company's inventions. After five years, the agency **anceled** part of the patent while allowing other aspects of it to remain.

Still, the patent became part of Hyatt's licensing deal with Philips, which has generated more than \$350 million. Philips deducted its costs and then split the proceeds 50-50, meaning Hyatt probably got more than \$150 million.

### \$388 Million

Hyatt, who speaks softly in conversations, doesn't hesitate to fight. When California, where he once lived, claimed he owed \$51 million in back taxes and penalties, he shot back with a lawsuit accusing state officials of harassing him and invasion of privacy. He won a record \$388 million award that's currently being reviewed by Nevada's Supreme Court.

He has taken the patent office to court more than 10 times to force the agency to reconsider rejections of some of his applications. He even **won** a case at the Supreme Court in 2012 over what type of evidence can be presented in district court.

"I got a whole bunch of cases referred back to the patent office telling them to do it right," said Hyatt. "I don't think they want to let it get to the board of appeals and therefore they keep running me around from examination to appeal, reopening prosecutions, examining, forcing me to appeal again and round and round."

In the January lawsuit, Hyatt alleges he was told by a PTO unit director that the agency's unofficial policy in dealing with him is to give him the runaround to avoid making a decision he could appeal. He said that may be why the patent office hasn't granted him a patent since 1997.

Ross, the PTO spokesman, wouldn't comment on the lawsuit, which was filed Jan. 3 in a U.S. district court in Las Vegas.

### Intel Connection

Hyatt, the son of a Russian emigrant and civil engineer, spent the early part of his career working for aerospace companies. He said he got his ideas for a business while at **Teledyne Technologies Inc.** in the 1960s.

He set up Micro Computer Inc. in 1968 to implement his ideas, with Noyce, who would co-found Intel that same year, as one of his investors.

"Dr. Noyce invested in my company personally because, from his standpoint, he thought it had merit," Hyatt said. "I was happy to get him because I thought Intel would build the chips."

Noyce, who died in 1990, often invested in Silicon Valley startups, said **Thomas Misa**, director of the Charles Babbage Institute Center for the History of Information Technology in Minneapolis, who likened it to someone backing a neighbor's ideas. Investing with Hyatt would have been consistent with his interests, he said.

"Bob Noyce was investor in everything," Misa said. "When he died, his family found a shoe box of promissory notes. He was very keen on building the electronics industry."

'Frugal Inventor'

Leslie Berlin, Noyce's biographer, and technology historian Ross Bassett, a professor at North Carolina State University in the city of Raleigh, said they couldn't find records showing Noyce invested with Hyatt, while agreeing with Misa's comments.

Hyatt, who describes himself as "at heart a frugal inventor," said it's clear he will never be placed in Silicon Valley's pantheon of founding fathers, even with his 1990 patent. He just wants a decision -- either give him a patent, he said, or a final rejection that he can appeal to a U.S. court.

While some of Hyatt's patents predate or are contemporary with those granted to executives at Intel and **Texas Instruments Inc.**, those companies made products that changed the world, Bassett said.

"I respect Gilbert Hyatt's work -- the process of engineering is difficult," Bassett said in a telephone interview. "But innovations are more than ideas. The broader context matters. If Gilbert Hyatt had never existed, I believe the microprocessor would have developed in the same way that it did."

--Editors: **Romaine Bostick**, **Bernard Kohn**

To contact the reporters on this story: **Susan Decker** in Washington at +1-202-624-1941 or [sdecker1@bloomberg.net](mailto:sdecker1@bloomberg.net); **Ian King** in San Francisco at +1-415-617-7171 or [ianking@bloomberg.net](mailto:ianking@bloomberg.net)

To contact the editors responsible for this story:  
Bernard Kohn at +1-202-654-7361 or [bkohn2@bloomberg.net](mailto:bkohn2@bloomberg.net);  
Pui-Wing Tam at +1-415-617-7327 or [ptam13@bloomberg.net](mailto:ptam13@bloomberg.net)  
© [2014] Bloomberg L.P. All rights reserved.



## PATENT-SUIT WINNERS CAN GET LEGAL FEES, U.S. HIGH COURT SAYS (2)

Apr 29 2014 14:58:50

(Updates with Highmark case in ninth paragraph.)

By Susan Decker

April 29 (Bloomberg) -- Companies that successfully fight off "unreasonable" patent lawsuits can get their legal fees paid, the U.S. Supreme Court ruled in a decision that may benefit Google Inc., Apple Inc. and other technology businesses.

The high court today gave trial judges more power to impose fees if they determine the case "stands out from others" in the conduct of the losing party. In a related opinion, the court also limited the ability of an appeals court to overturn a trial judge's decision in such cases.

"A case presenting either subjective bad faith or exceptionally meritless claims may sufficiently set itself apart from mine-run cases to warrant a fee award," Justice **Sonia Sotomayor** wrote for a unanimous court.

Apple and Google were among the companies urging the court to ease the rules, saying they are too often faced with frivolous infringement claims by patent owners who leverage the potentially high cost of litigation to prod quick settlements. Congress is considering legislation that would require the loser to pay the winner's fees in most circumstances.

"A lot of the so-called patent trolls thought they could get away with it, because they thought there was a small chance they could get hit with the attorney's fees, and this may change that," said **Brad Wright**, a patent lawyer with Banner & Witcoff in Washington who wasn't involved in the case. "They're trying to right the ship and level the playing field."

### 'Objectively Baseless'

Octane was **challenging** the test for awards established in 2005 by the U.S. Court of Appeals for the Federal Circuit, which handles patent cases. The Federal Circuit allowed fees if a suit is "objectively baseless" and was filed in bad faith, though in a December **ruling** it softened its stance.

More than 100,000 companies were threatened in 2012 alone with infringement suits by businesses whose sole mission is to extract royalty revenue, according to a White House **report**. Those entities, called pejoratively "patent trolls" by critics, filed 19 percent of all patent lawsuits from 2007 to 2011, **according** to the Government Accountability Office.

The case before the justices involves exercise-equipment maker Octane Fitness LLC, which is seeking as much as \$1.8 million in fees after defeating a patent suit. Octane was sued by Icon Health & Fitness Inc. over a component in elliptical machines.

### Highmark Case

In the second case, **Highmark Inc.**, a Pittsburgh-based insurer, is seeking to reinstate a \$5 million fee award it won after defeating a patent suit by Allcare Health Management Systems Inc. The court said the Federal Circuit, which threw out the award, should be more deferential to trial judges on the issue.

"The parties most likely to suffer an impact are those that commence litigation without performing a sufficiently detailed investigation," said Highmark lawyer **Cindy Kernick**, with Reed Smith in Pittsburgh. "Most legitimate patent holders tend to take formal, serious steps before they sue someone and the world has not changed for them. The changes are for those companies that have done no research at all, or what they do is an investigation on one company in an industry and then assume that every company in that industry does the same thing."

The U.S. Patent Act says fees can be awarded "in exceptional cases." The justices said the Federal Circuit rule was too rigid and made the standard the same as a federal law that allows for sanctions only if there is litigation misconduct.

### 'Exceptional' Cases

"An 'exceptional' case is simply one that stands out from others with respect to the substantive strength of a party's litigating position (considering both the governing law and the facts of the case) or the unreasonable manner in which the case was litigated," the court ruled.

That will require courts to determine whether it's just a case of two sides disagreeing on the scope of the patent or whether there is infringement, said **Paul Berghoff**, a patent lawyer with Chicago-based McDonnell Boehnen Hulbert & Berghoff.

"The rigidity of the old test is gone, but the Supreme Court has not opened the floodgates to district courts awarding legal fees in significantly greater cases," he said. "In any litigation, both sides develop almost instinctively skepticism of the other side's arguments. If you step back and look at it coldly and objectively, there aren't that many patent cases where blatantly frivolous arguments are being made."

The ruling shows there's no need for legislative changes, said **Rob Berman**, chief executive officer of patent-licensing company CopyTele Inc.

"Let the courts determine what's abusive and frivolous, don't legislate it," Berman said. "We don't take cases that are on the wrong side of the line. Has the line been moved a little bit? We don't know. We don't like to get even close to the line. To us, it's no big deal, as long as the judge has discretion."

The cases are Octane Fitness v. Icon Health & Fitness, **12-1184**, and Highmark v. Allcare Health Management Systems, **12-1163**.

--With assistance from **Greg Stohr** in Washington.

To contact the reporter on this story: **Susan Decker** in Washington at +1-202-624-1941 or [sdecker1@bloomberg.net](mailto:sdecker1@bloomberg.net) To contact the editors responsible for this story: Bernard Kohn at +1-202-654-7361 or [bkohn2@bloomberg.net](mailto:bkohn2@bloomberg.net) Romaine Bostick, Elizabeth Wasserman

© [2014] Bloomberg L.P. All rights reserved.

# Bloomberg

## Patent Lawsuits Limited by Supreme Court in Two Rulings

By Greg Stohr and Susan Decker - Jun 2, 2014

The U.S. [Supreme Court](#) ruled against patent holders in two cases, rejecting a legal theory used to sue technology companies and requiring patents to be written with more specific language.

The rulings come in a Supreme Court term heavy with patent cases as the justices look for ways to curb what companies such as Google Inc. and Cisco Systems Inc. say is rampant abuse by some patent owners.

Some technology companies and retailers say they are too frequently the target of lawsuits demanding payment by patent owners whose sole mission is to extract royalty revenue.

Though today's cases don't involve such companies, the rulings "can be used as tools" against them, said Brad Wright, a patent lawyer with Banner & Witcoff in Washington who wasn't involved in the cases.

One decision, involving exercise equipment maker [Nautilus Inc., \(NLS\)](#) "could be used to strike down vaguely worded patents, a problem that many technology companies complain about," Wright said. "It is this vagueness that sometimes gives rise to gray areas in the law, allowing questionable claims to go forward. This might allow courts to rein those in more."

The stakes are high for the companies and the broader economy. Industries with revenue tied the most to patent protection -- including drugmakers, technology companies and certain manufacturers -- generated \$763 billion, or 5.3 percent, of the 2010 U.S. gross domestic product, according to a Commerce Department report in 2012.

### Business Methods

During the past eight years, the Supreme Court has limited patent owners' ability to block non-competitors from using their inventions, made it easier to invalidate patents, and made it harder to get patents on business methods, medical diagnostics and isolated DNA.

In the other case today, the justices unanimously [said](#) companies can't be sued for inducing someone else to violate a patent unless there has been direct infringement of the patent.

That was at least a temporary victory for [Limelight Networks Inc. \(LLNW\)](#) in a legal clash with [Akamai Technologies Inc. \(AKAM\)](#). The justices sent the case back to a lower court to consider a separate legal theory pressed by Akamai.

Limelight rose by 1.8 percent to \$2.22 at 12:20 p.m. in Nasdaq stock market trading.

The case centers on Akamai's patented method for delivering video or graphics over the Internet during periods of high demand. Akamai says Limelight takes all but one step and induces its customers to perform the final step.

## Google, Cisco

Google, Cisco and [Facebook Inc. \(FB\)](#) were among the companies backing Limelight, along with the Obama administration. Eli Lilly & Co. and the drug industry supported Akamai.

In the Nautilus case, the court said a federal appeals court wasn't being rigorous enough in requiring specificity in the wording of patents. The [U.S. Court of Appeals](#) for the Federal Circuit, which specializes in patent cases, had said a patent's wording is adequate as long as someone who understands the technology can figure it out.

The justices today said the Federal Circuit standard isn't precise enough. The ruling is a victory for Nautilus, maker of Bowflex exercise equipment, which is seeking to invalidate a patent on a heart-rate monitor owned by Biosig Instruments Inc.

The justices [told](#) the Federal Circuit to reconsider the Biosig patent using a tougher test.

Google, [Amazon.com Inc. \(AMZN\)](#) and other companies said the Federal Circuit standard was too lax and allowed some owners to claim their patent covers far more than was invented.

The cases are Limelight Networks v. Akamai Technologies, 12-786, and Nautilus v. Biosig, 13-369.

To contact the reporters on this story: Greg Stohr in [Washington](#) at [gstohr@bloomberg.net](mailto:gstohr@bloomberg.net); Susan Decker in Washington at [sdecker1@bloomberg.net](mailto:sdecker1@bloomberg.net)

To contact the editors responsible for this story: Patrick Oster at [poster@bloomberg.net](mailto:poster@bloomberg.net) Laurie Asseo, Mark McQuillan



***Bloomberg BNA***

Supreme Court

## Supreme Court Tangled Up Separating Issues On Divided Infringement of Patented Methods

### BNA Snapshot

**Summary:** Supreme Court justices appeared unable to separate issues related to direct or induced liability for infringement when more than one party performs the steps of a patented method claim.

By **Tony Dutra**

April 30 — Standards for finding liability for infringement of a patented method claim when multiple parties are involved eluded the Supreme Court justices in oral argument April 30 in *Limelight Networks Inc. v. Akamai Techs. Inc.*, (U.S., No. 12-786, argued 4/30/14).

The case was the last the court will hear until next October. With quotes from justices such as “Perhaps I’m just confused,” “Maybe I don’t understand” and “I have no idea,” maybe the court wished it had ended this session a day earlier.

The joint or divided infringement issue comes up frequently in Internet applications, as here, where a service provider offers a service requiring interactive inputs from a customer. However, the difficulty in placing liability on one party also arises with method patents in areas such as banking, mobile phone communications, casino games and the life sciences—such as when a lab conducts a test and a physician acts on the result.

The problem in cases like this is in the intertwined relationship between direct and induced infringement, under Sections 271(a) and (b) of the Patent Act, respectively. The court was unsure whether it could resolve the latter—the only question presented in the cert petition that was granted—without resolving the former. And at least two justices acknowledged that the former had not been adequately briefed because the court did not grant the conditional cross-petition that would have brought that question front and center.

A suggestion by the respondent’s counsel that the court should conclude that the cert petition was improvidently granted was not greeted warmly. However, the court may take one of two other paths that would not wrap up the issue immediately.

First, the court gave some support to the idea of issuing an opinion that simply vacates the split decision on inducement by the U.S. Court of Appeals for the Federal Circuit that led to the granted cert petition, with a remand to have the appeals court try again under direct infringement theories.

Second, the court could grant the cross-petition, order more briefing on joint direct infringement and rehear oral argument next term.

### The Case So Far

Akamai Technologies Inc. and Limelight Networks Inc. offer competitive “content delivery networks” (CDNs), storing and delivering website content to Internet users on behalf of website operators.



Akamai owns a patent (**U.S. Patent No. 6,108,703**) on a “Global Hosting System” for web content. Limelight can only infringe the patent if it performs some steps of the asserted method claims and the websites of its customers perform the remainder.

The Federal Circuit, sitting en banc, was divided 6-5 in this case. ***Akamai Technologies Inc. v. Limelight Networks Inc.*, 692 F.3d 1301, 104 U.S.P.Q.2d 1799** (Fed. Cir. 2012) (en banc) (**173 PTD, 9/7/12**).

The appeals court took the case to review its recent jurisprudence on joint direct infringement, highlighted by an opinion in 2008 in *Muniauction Inc. v. Thomson Corp.*, **532 F.3d 1318, 2008 BL 146916, 87 U.S.P.Q.2d 1350** (Fed. Cir. 2008) (**137 PTD, 7/17/08**).

While joint direct infringement is acknowledged by all to be possible under common law theories of attributing one party's actions to another, the Federal Circuit's cases now limit such attribution to when one has “control or direction” over the other, which can be met only by an agency relationship or a contractual obligation by one party to the other to perform the steps.

However, the en banc court effectively ignored direct infringement in coming to its decision here, and it instead addressed only inducement. The court overturned its inducement standards of the past in holding that a patent owner claiming induced infringement—under *Section 271(b)*—no longer had to show that a single induced entity is liable for direct infringement under **Section 271(a)**. Under the appeals court's changed standard, Akamai in the instant case could conceivably hold Limelight liable for inducing website operators to use Limelight's CDN.

### Friends of the Court Split

The court granted cert to address Limelight's inducement appeal on Jan. 10 (**08 PTD, 1/13/14**).

***“Is there any policy reason for—that could support a holding—if you were in Congress, support the conclusion that there was not infringement on the facts here?”***

***Justice Samuel Alito***

Akamai filed a **conditional cross-petition** on the Federal Circuit's non-decision on direct infringement. *Akamai Techs. Inc. v. Limelight Networks Inc.*, No. 12-960 (U.S., review sought Feb. 4, 2013) (**05 PTD, 1/8/13**). The court considered the two petitions in the same conference, but made no decision on the cross-petition.

Friends of the court filed 22 briefs on both sides of the case (**74 PTD, 4/17/14**)(**75 PTD, 4/18/14**). The U.S. government supported Limelight's position and shared time at oral argument with the petitioner. The American Intellectual Property Law Association joined Akamai in arguing that both direct and induced infringement theories should be applied here.

In its April 22 **reply brief**, Limelight charged Akamai with trying “to deflect attention” from the inducement question presented in the case (**79 PTD, 4/24/14**). Based on the way oral argument proceeded, if that was Akamai's intent, it succeeded.

### Avoiding the End Run

Aaron M. Panner of Kellogg, Huber, Hansen, Todd, Evans & Figel, Washington, represented the petitioner, splitting time with Assistant to the Solicitor General Ginger D. Anders. Seth P. Waxman of Wilmer Cutler Pickering Hale & Dorr LLP, Washington, argued on behalf of Akamai.

Probably the toughest problem Panner faced was the lack of sympathy for his client. For example, Justice Elena Kagan characterized as a deliberate “end run” the act of getting another party to perform a method step to avoid infringement liability.

Justice Samuel A. Alito waited until Anders was up before asking: “Is there any policy reason for—that could support a holding—if you were in Congress, support the conclusion that there was not infringement on the facts here?”

Justice Stephen G. Breyer joined in that question and Anders failed to satisfy either's concerns. Justice Antonin Scalia stepped in to provide an answer.

"The policy reason is someone who does not even know about the existence of the patent, who happens to be one of the people who performs one or more of the steps, is suddenly automatically liable," Scalia said. "That's the policy reason. It's a strict liability tort."

### **Intertwined Provisions and Policy**

However, that brought the question back to Section 271(a) and strict liability for direct infringement, causing Anders to put it back on the court to determine "what tort principles to incorporate in 271(a)." She acknowledged the *Muniauction* principal/agent relationship as one that could lead to a finding of joint direct infringement, but she said there was "a significant concern" should the court choose "to broaden that out."

Kagan said the Federal Circuit had thus been "very clever by putting it into a 271(b) box and avoiding the strict liability consequences of what they were doing, but also avoiding the possibility of an end run of the patent law."

"And also avoiding the text of the statute," Scalia said to laughter.

"There is that problem," Kagan said, joining the audience.

***"And it's under those circumstances that I say okay, let's go with what we've had for 30 years, and if Congress feels they should change it, change it."***

***Justice Stephen Breyer***

Kagan, in an earlier discussion with Panner, had noted that the direct infringement question is still within the Federal Circuit's purview if the high court reverses on inducement.

"If they did reach it a second time around and they decided well, now that this inducement theory is not available to us, we think that there is a real problem here, that there is a kind of end run around the patent law and so we're going to change what we think on the 271(a) question," Kagan said of the appeals court. "If they did that, it would be right to say it would render our opinion on the 271(b) question a nullity?"

Chief Justice John G. Roberts Jr. came to Panner's rescue in this colloquy:

Roberts: I just want to make clear, you're saying that under existing law, the question presented makes a huge difference; if existing law is changed, it may not make a difference?

Panner: That's exactly right.

Roberts: I suppose that's true in every case we hear.

Panner: That's well said, Your Honor. Thank you.

### **Let Congress Decide, But What?**

Kagan persisted, but Panner, nearing the end of his argument time, closed by reiterating his primary point.

"The Federal Circuit did make a policy judgment, tried to amend the statute to reach a result that they thought was fair in the particular case," he said. "That's a job for Congress."

In a discussion with Waxman, Breyer gave hints that he agreed, but in a way that Panner would probably not like.

Breyer insisted that the issue was complex because "of so many different kinds of situations with so many different steps in method patents where so many rights and wrongs of it are differently at play." And then he said, "And it's under those circumstances that I say okay, let's go with what we've had for 30 years, and if Congress feels they should change it, change it."

The reference to 30 years would appear to indicate he was in favor of reversing the Federal Circuit's new view of inducement, but the Federal Circuit's *Muniauction* view of direct infringement is only six years old as well. Indeed, Waxman said that if anything the Federal Circuit has done recently is "new," it is what the appeals court decided in 2008.

It was unclear whether Breyer was thus also asking whether the Supreme Court should do something here to roll jurisprudence back to the pre-2008 view of more opportunity to find "direction or control" by one party under Section 271(a).

### Claim Drafting

One possible way out for the court was the suggestion that the problem here was a result of inadequate claim drafting by Akamai, but the court appeared to have no taste for that argument.

The minority opinion in the Federal Circuit's en banc decision below put much of the problem on the structure of Akamai's asserted patent claims. Panner relied on that to some extent, citing the "long understood principle of patent claim drafting that method claims should be drafted from the point of view of a potential infringer so that all of the steps can be carried out by that potential infringer."

Roberts and Scalia nevertheless believed that infringement of all such single-actor claims could be avoided by one party "outsourcing" or otherwise "making it attractive" to perform at least one step.

The U.S. government's amicus brief acknowledged that single-actor claim drafting is not always possible, and Justice Sonia M. Sotomayor requested examples. Anders mentioned "patents that involve the use of different machines that have to be operated by two people."

But Waxman had a better example.

Let's assume that there is disclosure and patenting of a cure for cancer or a novel treatment for cancer that involves, as they often do, the administration of different drugs sequentially. And two parties get together and say, I'll administer drug 1, you administer drug 2, and we can take advantage of this marvelous patented process without paying anything, [without] giving anything whatsoever to the company that spent a billion dollars and 25 years developing.

### Will the Court Postpone?

As noted above, the court could follow Breyer's suggestion to reject recent jurisprudence by the Federal Circuit on divided infringement, on inducement only or adding statements about direct infringement.

***"The fate of the cross-petition could produce an interesting wrinkle."***

***AIPLA's James D. Crowne***

Based on the smiles on the justices' faces and the laughter in the room, the court is unlikely to take Waxman's suggestion that "the best option for the court would be to simply dismiss the petition as improvidently granted."

However, they are more likely to consider his alternative. Or as James D. Crowne of the American Intellectual Property Law Association put it to Bloomberg BNA after the session, "The fate of

the cross-petition could produce an interesting wrinkle."

"I think the court came to the halting realization that it had taken up the wrong issue, or at the very least it took up an issue which might not ultimately matter," J. Michael Huget of Honigman Miller Schwartz and Cohn LLP, Ann Arbor, Mich., told Bloomberg BNA after the argument. "Ironically, the court created a 'divided infringement analysis' issue by not granting the cross-petition for certiorari in the first place to address the question of the standard for finding infringement when separate parties act in concert to infringe a patent."

"Although that might be somewhat unusual procedurally, several justices expressed concern with addressing 271(a) on the current briefing," H. Wayne Porter of Banner & Witcoff Ltd., Washington, told Bloomberg BNA of the possibility of granting the cross-petition now.

For example, when Justice Ruth Bader Ginsburg asked Anders for the government's position on joint direct infringement, Anders gave reluctant support to Waxman's idea. "If the court were to decide that issue," she said, "we think it probably should order further briefing."

Breyer also hinted something similar.

"I become very nervous about writing a rule that suddenly might lead millions of people to start suing each other," he said, referring to direct infringement. "And that's what I would not like to do unless I have pretty thorough briefing on this subject."

"It would have made sense to grant the cross-petition, but I think they could decide the case without it," AIPLA's Crowne said. "The most important part of the inducement case is evidence that all of the steps of the method were performed to demonstrate the underlying infringement."

Crowne thus appreciated that Waxman distinguished that "you can have an infringement without liability," but then again, he was not convinced the justices were making that distinction.

"It's really hard to tell where the majority is," he said.

"If the court does not think that it must address 271(a), I think the court would be willing to simply reverse or affirm and indicate that it's up to Congress to fix any perceived problems or gaps in the law," Porter told Bloomberg BNA.

To contact the reporter on this story: Tony Dutra in Washington at [adutra@bna.com](mailto:adutra@bna.com)

To contact the editor responsible for this story: Naresh Sritharan at [nsritharan@bna.com](mailto:nsritharan@bna.com)

#### **For More Information**

Transcript is available at [http://www.supremecourt.gov/oral\\_arguments/argument\\_transcripts/12-786\\_i4dj.pdf](http://www.supremecourt.gov/oral_arguments/argument_transcripts/12-786_i4dj.pdf).

Crowne is a member of this journal's advisory board.

## DESIGN PATENT LAW STAKEHOLDERS IDENTIFY TRENDS DISTINGUISHING UTILITY PATENT RULES

Nov 24 2014 19:48:33

Design Patent Law Stakeholders Identify Trends Distinguishing Utility Patent Rules

By Tony Dutra

2014 Design Law Symposium

Takeaway: Instant knock-offs, software application screen design, 3D printing and other trends create problems in design patent law more akin to intellectual property regimes other than utility patent protection.

Nov. 24 (BNA) -- Is design patent law at a crossroads? Stakeholders at a Nov. 21 conference in Washington, identifying points of divergence from both the statute and jurisprudence as to utility patents, asked whether Patent Act changes specific to design are required, or even whether a special scheme-similar to that adopted for boat hull designs-is necessary.

The common theme throughout the session was that the Apple v. Samsung case, to be heard by the Federal Circuit on Dec. 4, is largely responsible for exposing the differences.

### Trends Creating Upheaval

The 2014 Design Law Symposium was held at George Washington University Law School before about 150 attendees. GW Law School, the Center for Intellectual Property Research at the Indiana University Maurer School of Law, and the law firms of [Banner & Witcoff Ltd.](#) and Sterne, Kessler, Goldstein & Fox PLLC hosted the event and supplied moderators for four panels.

After separate 1.5-hour discussions each on remedies, functionality and prior art, Sterne Kessler's Tracy-Gene G. Durkin and Robert S. Katz of Banner & Witcoff held a "town hall discussion" with several votes that indicated a divide among stakeholders-not only patent lawyers but industrial designers as well-in answering the question: Are changes needed?

Katz identified the most significant trends causing the stress and possible need for statutory change:

\* Knock-off designs are appearing on the market as soon as the patent application is disclosed, creating a period without remedy and giving the knock-off maker early entry. The audience was evenly divided as to their support for a move to a registration system similar to copyright, a preference preferring the examination system, and those calling for a "hybrid" system of quick registration and an optional follow-up examination.

\* Protection for graphical user interfaces-"temporary designs" because they do not remain constant on the screen-is driving much of the discussion. Michael Risch, professor at the Villanova University School of Law, challenged Apple's D,604,305 screen design patent, one part of the Apple v. Samsung case, to the dismay of a few audience members who defended awarded protection to GUIs.

\* More vexing in the potential outcome of Apple v. Samsung is how it will affect remedies available to design patent owners. Issues include whether protection of a portion of a product can justify an injunction against the entire product, whether the damages calculation requires apportionment, and how to deal with unjoined ongoing infringement. An apportioned royalty won't stop copycats, Perry J. Saidman of Saidman Design Law, Silver Spring, Md., said. "They will just keep going. It'll be a cost of doing business."

\* 3D printing adds a copyright-like "Napster problem," because the profit-making infringer creates only a digital model of the patented design and no finished product. Users are the actual copiers, and the negative publicity of copyright owners bringing infringement cases against end users is still fresh in stakeholders' minds.

\* Obviousness analysis has created specific problems for courts because "design is a unitary thing," as Christopher V. Carani, McAndrews Held & Malloy Ltd., Chicago, said. That fact makes it difficult to understand exactly what a court is doing when it combines prior art references to find obviousness, according to one audience member.

And pervasive throughout the discussion was the fact that infringers come in three types-direct competitors, such as Apple and Samsung in the mobile phone market; knock-off manufacturers, more similar to generic drug makers; and downstream suppliers of patented parts, such as for automobiles.

Does Section 289 Need Tweaking?

That difference led Sarah Burstein of the University of Oklahoma College of Law, in the panel on remedies, to ask a fundamental question: "What's the point of design patents? To deter copycats, or to incentivize creative design?"

The remedies session, moderated by Katz and John Whealan, associate dean for intellectual property law at George Washington, featured a debate on interpretation of Section 289 of the Patent Act, 35 U.S.C. §289, which is specifically directed to damages for design patent infringement. Section 289 makes the infringer "liable to the owner to the extent of his total profit, but not less than \$250," in addition to "any other remedy which an owner of an infringed patent has under the provisions of this title, but he shall not twice recover the profit made from the infringement."

All participants agreed that \$250 is absurdly low, but the primary question was as to the meaning of the word "extent." Maurer Law School Professor Mark D. Janis contended that it meant the full extent of total profit should be awarded, while Whealan read it to give judicial discretion to award less than total profit.

Natalie Hanlon-Leh of Faegre Baker Daniels, Denver, tied injunction and damages issues in light of Apple v. Samsung, with Apple's inability to establish a causal nexus between the iPhone's design and customers' purchase decisions (223 DER A-3, 11/19/13).

That failure negates the required finding of irreparable harm for an injunction, she said, and, when design is merely one aspect of the purchase decision, causes courts to make the parallel to apportionment as applied in utility patent cases.

Consumer surveys can identify a nexus, an audience member contended. But Katz said the cost of such a survey is so high that it doesn't make economic sense to do it for a "small infringer."

Burstein, Hanlon-Leh and Janis have all filed amicus briefs in the case now before the Federal Circuit (Apple Inc. v. Samsung Electronics Co., Ltd., No. 2014-1335 (Fed. Cir.) (186 DER A-31, 9/25/14).

#### Functionality Not Really Design Issue

Durkin of Sterne Kessler, Washington, and Richard S. Stockton of Banner & Witcoff LLP, Chicago, moderated a panel on how courts have "factored out" functional aspects of a design patent.

Risch of Villanova presented his argument in the session on GUIs and screen design, arguing that factoring out in design patent law is similar to, and as useful as, filtration in copyright law.

But Saidman insisted, "There is no such thing as a design patent that is invalid for functionality." He noted that Section 171 doesn't even use the word, and said that courts have improperly been interpreting the word it does use-"ornamental"-as "non-functional."

He said that the only true test of functionality is whether there are alternative designs that would perform the same function. If so, the patent undoubtedly is claiming to be about ornamental aspects, he said, and if not, it should be a utility patent and not a design patent.

John J. Cheek, deputy IP counsel at Caterpillar Inc., was on the panel as well, describing the peculiarities of "the parts and component landscape." The firm typically files a combination of utility and design patents on the same part, and, he said, the difficulty is in ensuring that engineers who are not industrial designers avoid using functional language.

#### AIA Changes to Prior Art Ignore Designs

Carani's presentation was in the panel on prior art. It further featured words of caution about the changes in Section 102 resulting from passage of the America Invents Act, which, he suggested, showed little or no awareness of problems specific to design patents.

For example, Carani said, "Don't get lulled into the idea that you have a grace period." If you show your design at a trade show, he said, and an intervenor copies the design except for one insubstantial change, it can serve as a prior art reference. The AIA assumed a claim of derivation would disqualify third-party intervening prior art, but, he said, "Good luck trying to prove derivation" in design.

Jason Du Mont, fellow at the Center for Intellectual Property Research at the Maurer School of Law, moderated the panel, which also included Elizabeth Ferrill of Finnegan, Henderson, Farabow, Garrett & Dunner LLP, Washington; Mark A. Charles, Washington-based senior counsel at Procter & Gamble Co.; and Brian E. Hanlon of the U.S. Patent and Trademark Office.

Charles's talk was perhaps the most disturbing to prospective patent applicants. He noted the problems his firm is experiencing with designs being prematurely published on the Internet, leading to "all kinds of mockups being posted on the web" that-as patent-defeating prior art-preempt additional design variations the firm is considering.

For example, Charles said, Apple already has to deal with prior art posted on social media sites "suggesting what the iPhone 8 should look like."

To contact the reporter on this story: Tony Dutra in Washington at [adutra@bna.com](mailto:adutra@bna.com)

To contact the editor responsible for this story: Tom P. Taylor at [ttaylor@bna.com](mailto:ttaylor@bna.com)

#### For More Information

Conference materials at <http://designlaw2014.com/sessions/>.

To view the complete story, {FIFW BBLS DD PKA0F9M5J0U3}

Run {BNA} to subscribe to Bloomberg BNA Law Reports.

The above story appeared in:

Daily Report for Executives



***Chemical & Engineering News***



Home &gt; Tug Of War Over Promising Cancer Drug Candidate

## Over 2 Million Citations >>>

ACS Journals have more than doubled in citations since 2004 as reported in the 2013 release of the Journal Citation Reports® from Thomson Reuters.

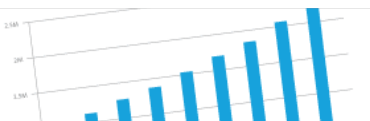

### Latest News

Web Date: May 21, 2014

## Tug Of War Over Promising Cancer Drug Candidate

Drug Discovery: Structure error threatens existing patent and clinical trials

By **Stu Borman**

Department: [Science & Technology](#) | Collection: [Life Sciences](#)

News Channels: [Biological SCENE](#), [Organic SCENE](#)

Keywords: [structure](#), [drug discovery](#), [patent](#), [Oncoceutics](#), [TIC10](#), [U.S. patent 8673923](#), [ONC201](#)

[+]Enlarge

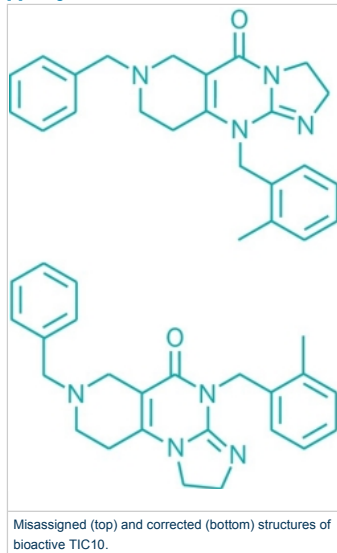

Misassigned (top) and corrected (bottom) structures of bioactive TIC10.

A promising anticancer agent about to enter human clinical trials is on the hook because of a chemical structure error discovered by scientists at Scripps Research Institute California. The patented compound, known as TIC10 or **ONC201**, is owned by the biotech firm Oncoceutics. However, Scripps has applied for a patent on the corrected structure and has licensed it exclusively to another company, Sorrento Therapeutics.

The reanalysis and relicensing could lead to an unprecedented legal case—the first in which a structural reassignment puts in jeopardy a patent and clinical trials.

Lee Schalop, Oncoceutics' chief business officer, tells C&EN that the chemical structure is not relevant to Oncoceutics' underlying invention. Plans for the clinical trials of TIC10 are moving forward.

Cancer researcher **Wafik S. El-Deiry** of Penn State University and Penn State Hershey Medical Center and coworkers found TIC10 in a search of a free [National Cancer Institute](#) database and pinpointed its anticancer activity. They found that the compound kills cancer cells by stimulating gene expression of a tumor suppressor protein called TRAIL (*Sci. Transl. Med.* 2013, DOI: [10.1126/scitranslmed.3004828](#)). TIC10 stands for "TRAIL-inducing compound 10." They used mass spectrometry to try to confirm that the structure of the compound was the same as that listed in the NCI database.

The Penn State group patented TIC10 with that structure (U.S. patent 8673923) and licensed it to Oncoceutics, a company cofounded by El-Deiry. According to Oncoceutics, several research institutions have found TIC10 to be effective in vitro and in vivo against glioblastoma (brain cancer), prostate cancer, melanoma, sarcomas, and lymphoma and to have a favorable safety profile in rat and dog toxicology studies. Oncoceutics has initiated Phase I/II clinical trials of TIC10, supported in part by a Pennsylvania Department of Health grant.

Scripps's **Kim D. Janda** and coworkers got interested in TIC10 for use in a possible anticancer combination therapy. When they synthesized the patented structure, they found it to be biologically inactive. But when they obtained TIC10 from NCI, it was bioactive. They used X-ray crystallography and total synthesis to confirm that bioactive TIC10 has a different structure than that shown in the patent (*Angew. Chem. Int. Ed.* 2014, DOI: [10.1002/anie.201402133](#)).

Janda concluded that Oncoceutics and the other research institutions had been working on the bioactive compound but that the company patented the inactive structure. Scripps applied for a patent on the correct structure and licensed it exclusively to [Sorrento Therapeutics](#), where Janda is a director.

When C&EN informed Jerry M. Collins, an administrator of the NCI chemical library that provided TIC10, about the misassignment problem, he said the facility's lead chemist would look into the structure and correct it if warranted.

The structures of many compounds have posed problems before. For example, reagent vendors marketed an incorrect isomer of the Pfizer anticancer agent bosutinib for research purposes ([C&EN](#), [May 21, 2012](#), [page 34](#)). But no patents or clinical trials were at issue in previous cases.



### MOST POPULAR

Viewed Commented Shared

[Tapping Solar Power With Perovskites](#)

[Forcing Change In Forensic Science](#)

[Global Top 50](#)

[Multifaceted Collaboration Solves Natural Product Puzzle](#)

[Top 50 U.S. Chemical Producers](#)

\*Most Viewed in the last 7 days

### RELATED ARTICLES

[Total Synthesis Surprise](#)

[Bosutinib Buyer Beware](#)

Advertisement

Asked to comment on TIC10, [Nick Levinson](#), the Stanford University postdoc who discovered the bosutinib problem, says, "I find it astonishing that a drug candidate can get this far through regulatory controls and into trials without the key players actually having done the proper quality control. It points to a serious hole in the whole process."

C&EN requested comment on the issue from two patent attorneys who are not involved. [John P. Iwanicki of Banner & Witcoff, in Boston](#), says prior research and publications on bioactive TIC10 could prevent the Scripps patent application from being approved by the U.S. Patent & Trademark Office even though the structure in the Oncoceutics patent is incorrect. And patent attorney Kendrew H. Colton of [Fitch, Even, Tabin & Flannery](#), in Washington, D.C., says the Scripps patent application could run into trouble if isolation or identification of bioactive TIC10 "would have been within the skill of a person working in this field."

Sorrento Therapeutics patent attorney Jeff Oster notes that the company "prepared the patent application with those issues in mind" and believes its claims "are patentable over what will be the prior art of record."

[Jay Lichter](#), managing director of the investment firm Avalon Ventures, in La Jolla, Calif., comments that venture capitalists are unlikely to invest in expensive clinical trials sponsored by Oncoceutics—or by Sorrento Therapeutics, for that matter—until TIC10's ownership is clarified, either legally or via collaboration between the two companies.

Chemical & Engineering News  
ISSN 0009-2347  
Copyright © 2014 American Chemical Society



Info for Advertisers

### Leave A Comment

Thank you for your comment. Your initial comment will be reviewed prior to appearing on the site.

Name

Email Address(Required to comment)

Submit Query

Pick a field — C&EN will keep you up to date  
analytical | environmental | materials | biological

**SCENE**

#### Chemical & Engineering News

Home  
Magazine  
News  
Departments  
Collections  
Blogs  
Multimedia  
Jobs

Subscribe  
Advertise  
Contact  
Join ACS  
About



Help  
Sitemap

Search

Submit Query

Advanced Search

#### American Chemical Society

ACS.org  
ACS Publications  
CAS

Copyright ©2014 American Chemical Society





## Video streaming service Aereo loses at Supreme Court

Justices say Aereo's Web-based streaming video service violates the performance right in copyright law

Grant Gross (IDG News Service) | 26 June, 2014 01:55

The U.S. Supreme Court has ruled that Web-based video streaming service Aereo, which rebroadcasts over-the-air television through antenna farms, violates the copyrights of TV networks.

The court, in a ruling targeted specifically at the company's technology, decided that Aereo infringes the performance right section of copyright law by selling subscribers a service that allows them to watch TV programs over the Internet at "about the same time" as the programs are broadcast over the air, [wrote Justice Stephen Breyer](#) for the 6-3 majority.

The 2-year-old Aereo -- which was sued for copyright infringement by ABC, CBS and other broadcast TV networks -- argued that it rents each subscriber an antenna and a DVR service. Subscribers individually choose what programs to watch, and unlike cable and satellite TV services, which pay royalties to some networks, Aereo does not give thousands of people access to the same TV show at the same time, [Aereo had argued](#).

The Supreme Court reversed [an April 2013 ruling](#) from the U.S. Court of Appeals for the Second Circuit saying Aereo service was legal because the company makes use of several legal technologies, including mini TV antennas, DVRs and a Slingbox-like streaming service.

But the U.S. Congress in 1976 amended the Copyright Act, negating an earlier Supreme Court ruling, that exempted community antenna television (CATV) systems, a cable-like precursor to Aereo, from copyright infringement claims, Breyer wrote.

Under the definitions of the amended Copyright Act, Aereo performs or transmits TV content that is protected by copyright, he said.

"This history makes clear that Aereo is not simply an equipment provider," Breyer wrote. "Aereo sells a service that allows subscribers to watch television programs, many of which are copyrighted, almost as they are being broadcast."

An argument from Aereo and from dissenting justices, including Justice Antonin Scalia, that the company's service doesn't provide a continuous video stream "makes too much out of too little," Breyer wrote. "Given Aereo's overwhelming likeness to the cable companies targeted by the 1976 amendments, this sole technological difference between Aereo and traditional cable companies does not make a critical difference here."

Scalia, in his dissent, compared Aereo's service to businesses offering photocopying services. "A copy shop rents out photocopiers on a per-use basis," he wrote. "One customer might copy his 10-year-old's drawings -- a perfectly lawful thing to do -- while another might duplicate a famous artist's copyrighted photographs ... Either way, the customer chooses the content and activates the copying function; the photocopier does nothing except in response to the customer's commands."

Digital rights group Public Knowledge questioned the ruling. "It is very unfortunate for consumers that the Supreme Court has ruled against Aereo," said Barteaux Cox, a spokesman for the group. "Aereo is a true innovator in the TV industry and provides high quality and affordable programming for its customers. We look forward to seeing what Aereo will do in response to the Supreme Court's ruling."

The decision may have an "initial effect on technological development," added Ross Dannenberg, an intellectual property lawyer at Banner & Witcoff's Washington, D.C., office. "In the back of their minds, [tech entrepreneurs] will be thinking, 'remember what happened to Aereo? They spent all that money and then were shut down'."

But the Supreme Court went "out of its way in an attempt to prevent the decision from stifling innovation" by focusing on Aereo's specific technology, he added by email.

Although Aereo supporters had raised concerns about the impact of a decision against the company on cloud service providers, the court said those types of businesses should be unaffected, Dannenberg said.

Andrew Goldstein, a partner at Freeborn & Peters in Chicago, agreed that the decision was limited.

"The Supreme Court majority opinion emphasized that they are not ruling on future technologies that are not before them at the moment; and that given the limited nature of the holding the court does not believe this decision will discourage the emergence of use of different kinds of technologies," he said by email.

Remote DVR services may be affected, but other technologies aren't covered by the ruling, he said.

"I do not believe that this decision makes it tougher in general to launch new innovative services," he said. "If anything, this case is a lesson to new technology developers that if you build your business on a loophole in the law, similar to Aereo, your business may be akin to a house of cards."

*Grant Gross covers technology and telecom policy in the U.S. government for The IDG News Service. Follow Grant on Twitter at GrantGross. Grant's email address is grant\_gross@idg.com.*

---

Copyright 2014 IDG Communications. ABN 14 001 592 650. All rights reserved. Reproduction in whole or in part in any form or medium without express written permission of IDG Communications is prohibited.

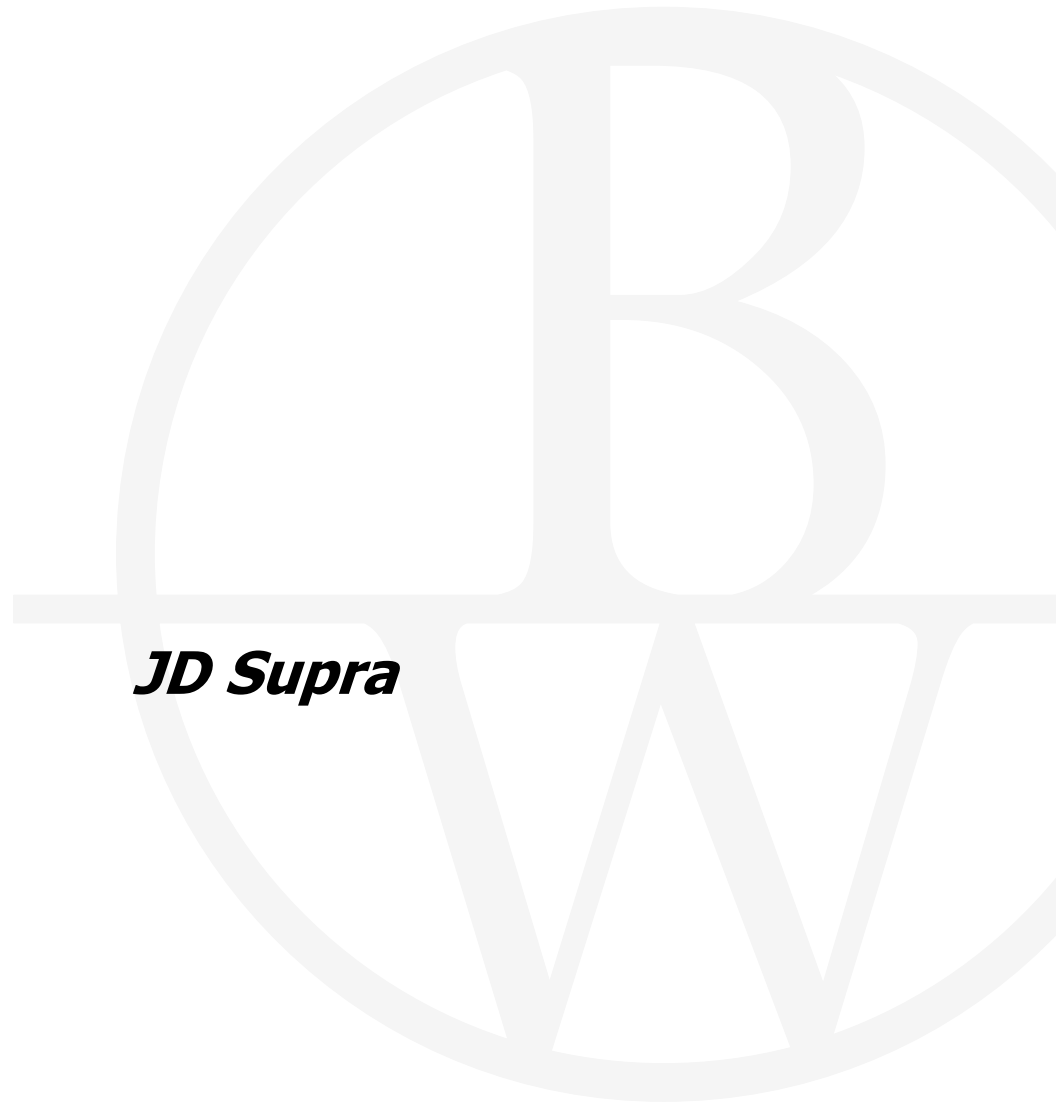

***JD Supra***

NEWS &amp; INSIGHTS

TRENDING [7]

FIND AN AUTHOR

MORE

## JD SUPRA® BUSINESS ADVISOR

# 7 Intellectual Property Mistakes Startup Entrepreneurs Often Make

2/3/2014 by [Ray Arner](#), [Tom Arno](#), [Stephen Charkoudian](#), [Helen Christakos](#), [James Coffey](#), [Ashley Dobbs](#), [Richard G. Frenkel](#), [Michael Guiliana](#), [Lacy Kolo, Ph.D.](#), [Salima Merani](#), [Eugene M. Pak](#), [Aseet Patel](#), [Timothy J. Shea](#), [Chris Sloan](#), [Scott M. Smith](#), [Robert Stier Jr.](#), [Henry Welles](#) | [JD Supra Perspectives](#) [Contact](#)

Like 93

g+1 5

Tweet 104

Share 20

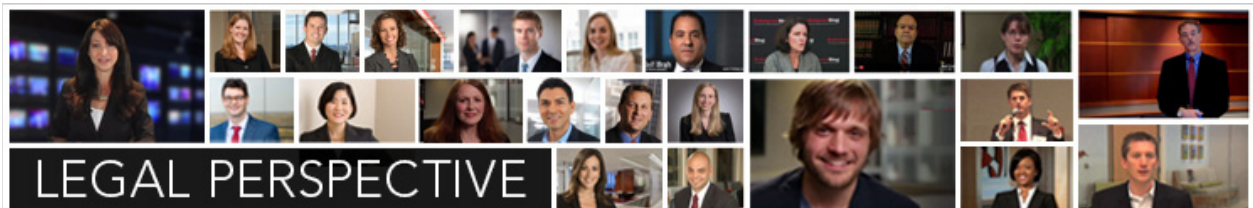

You have a great idea, a solid team, the beginnings of a viable product that appears to be gaining early traction in the marketplace, interest from investors, and ... *what else?* Well, for one thing: not enough time in the day to get it all done. And for another: you have intellectual property and it needs to be protected.

*What's the biggest mistake startup entrepreneurs make with respect to their intellectual property, and what can they do to fix it?*

That's the question we recently put to IP attorneys writing on JD Supra, knowing that the diversity of responses would make for interesting reading. We weren't disappointed. Here's what we heard back:

## 1. Entrepreneurs Don't Invest Sufficient Time, Money, and Thought In Their IP

We heard this sentiment expressed in a number of ways, each with a key takeaway for early IP protection:

### *Waiting Too Long*

From [Scott Smith](#), a Palo Alto-based IP attorney with Dorsey & Whitney: “Startup entrepreneurs have been taught, rightfully so, that they need to be extremely cash conscious and to control burn rate above all else. One obvious way to control burn is to keep legal fees to an absolute minimum. With intellectual property, however, skimping too much in the early days can be devastating in the long term and even in the short term. Almost always, a large chunk of a startup’s most valuable, innovative intellectual property is produced in the early days of the company. After all, it is usually the big, 'Aha!' ideas that make entrepreneurs want to start companies in the first place.

Ideally, a startup will invest a reasonable, manageable amount of its budget to protect these big innovations with patent applications from the beginning, and the money spent will pay huge dividends later, as the company adds further

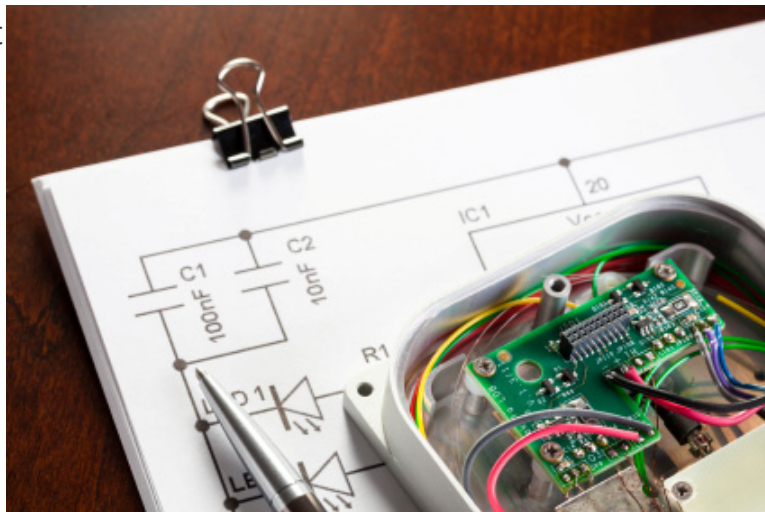

innovations and iterations to the big ideas. Unfortunately, I have seen many startups that fail to make this investment. Perhaps they file one, poorly drafted provisional patent application, written by the entrepreneur for example, and do nothing else for a year. Or worse, they don't file anything, thinking they will wait until they have more funding before “getting serious” about IP. This can be fatal. The U.S. is now a 'first-to-file' country, which means



if a company waits too long to file a patent application, it may lose the race completely, even if it invented first. Additionally, most countries have no grace period between the time an invention goes public and when the inventors can file a patent application. This means that if your inventive ideas are published or made available for sale or presented at a trade show before you file a patent application, you have lost almost all patent rights immediately outside the U.S.”

---

*...if you don't make a decision, the decision might be made for you. -*

Chris Sloan of Baker Donelson

---

### *A Weak Initial Filing*

From [Timothy J. Shea, Jr., Ph.D.](#), a director at Sterne, Kessler, Goldstein & Fox in Washington, DC: “Too often we see initial filings that are poorly drafted, that are either too narrow in focus to provide effective protection or too broad to properly support the claim scope sought, and that contain overreaching, speculative language that prejudice the startup's ability to obtain strong protection for its later inventions. Unfortunately, a weak initial patent filing can be devastating for several reasons. First, much, if not most, of the value of startups to potential investors lies in the company's IP - particularly for companies in the biopharma space where actual products will take years to get to market. A weak patent filing that does not adequately protect the company's key technology and products will substantially reduce the value of the company to potential investors. Second, a weak filing can also convey to potential investors a lack of sophistication on the part of the company regarding its IP matters generally. Third, the initial filing will eventually become 'prior art' (and often the most relevant prior art) to the company's subsequent patent filings. To the extent the first filing is overreaching and contains too much speculative language, it can become a dangerous piece of prior art that is cited by the patent office as a basis for rejecting the company's later patent applications to improvements in the underlying technology. So even though the initial filing may be too speculative to

adequately support the claims pursued in that filing, it can nevertheless still be effective prior art that "poisons the well" for the company's later patent filings. Fortunately, by engaging a competent patent attorney and devoting the appropriate amount of time, thought and resources to its initial patent filing, the company can have a patent application that provides a strong foundation on which to build a valuable patent portfolio around its platform technology and products."

#### *No Clearance Search*

[Noreen Weiss Adler](#), partner at Barton LLP: "Companies with a product that involves new technology or a proprietary business process can make a serious mistake by not investing in a patent clearance opinion. Failing to investigate whether your technology infringes on a pre-existing patent can expose the company to punitive, treble damages if it loses a lawsuit based on infringing a pre-existing patent because failure to conduct a patent clearance analysis (although in and of itself does not lead to a presumption that the company willfully infringed on the pre-existing patent) can still be used as evidence to support a claim of willfulness, which in turn can give rise to punitive damages. Additionally, because the value of the IP can be a start-up's most valuable asset, lack of a patent clearance opinion can adversely affect company valuation with a resultant negative impact on the amount of capital a company can raise."

[Eugene M. Pak](#), partner and the leader of Wendel Rosen's Intellectual Property practice group: "In the rush to get things started and conserve funds, start-ups often overlook doing a clearance search for their brands and filing to register their trademarks. Reserving a corporate name with the Secretary of State, or even filing a fictitious business name statement, is not the same as registering one's trademarks. Trademark registration, although not required, gives companies broader rights and helps deter others from using the same or similar marks. Since the registration process can take a year or more, getting started early can be beneficial. Under the federal registration system, one can

file to register a trademark that has not even been used yet (intent-to-use application), so long as one has a bona fide intent to use the trademark."

#### *No Focus on Global Patent Standards*

[Salima Merani, Ph.D.](#), partner at Knobbe Martens: "Startups, with their limited budgets in the very early stages, often file patent applications without an eye towards global patent standards. Years later, when it comes time to pursue international rights outside the United States, the deficiencies from the early days can come back to impede or impair the patent portfolio. Sophisticated startups, typically involving some venture firm board members or serial entrepreneurs, not only engage law firms that have a global perspective, but also invest meaningfully in intellectual property and global strategy even when funds are scarce."

#### *No Real Strategy*

[Robert Stier, Jr.](#), at Pierce Atwood LLP: "Too often, in a rush to get IP protection, startups assume that all patents are of equal value. They spend money needlessly on patent prosecutions only to obtain claim coverage that is too narrow, and they end up without any real barrier to entry against competitors. Their time and effort would be better spent first understanding the IP landscape and then developing a realistic strategy for cordoning off valuable portions of that territory. That requires more of an investment of time and money up front, but it results in long term savings and a stronger competitive position."

---

*A strategically-designed patent portfolio is equally as valuable to a company as a robust data package is for its product... - Ray Arner,  
Pierce Atwood*

---

[Ray Arner](#), also of Pierce Atwood: "Start-ups frequently consider patenting on a piecemeal basis, and in an excessively cost-conscious manner. They opt to

spend their money on science rather than legal expenses. This is understandable, but short-sighted. Decisions of this type may cause a start-up to forego formulating a cohesive patent strategy around a nascent product or technology platform. Consequently, their first patent filing is often too soon or too late, or it shoots the project and the patent strategy in the foot. A strategically-designed patent portfolio is equally as valuable to a company as a robust data package is for its product. Investors require both.”

[Chris Sloan](#), co-chair of Baker Donelson’s Emerging Companies group: “This is not to say you should file patents and trademark applications on anything and everything; you can easily spend tens of thousands of dollars doing that. The key is to have a plan and know what you want to protect and when to do it. Put another way, if you don’t make a decision, the decision might be made for you.”

## 2. Entrepreneurs Seek Patent Protection(s) Too Early

---

*...the key question is how much, and when.* - Rick Frenkel, Latham & Watkins

---

The many points above notwithstanding, [Rick Frenkel](#), a partner in Latham & Watkins’ Silicon Valley office, counters that startups can also place too much emphasis and worry on IP in the earliest stages of the company, thereby “seeking a wide variety of patent protection that later turns out to be unrelated to where the company actually ends up heading.”

Frenkel suggests: “Rather than investing that money with the US Patent & Trademark Office and patent attorneys, it might be better spent on developing the company’s product. Patents are typically used for three major purposes by operating companies (as opposed to patent trolls). First, patents can be used against competitors, to forge a better business position. But this can hardly be true as to startups, since patents take years to grant, and competitors by definition are going to be much better established and with

deep pockets. Second, patents can be used for defensive reasons, in case sued by competitors, so the company can fight back. But this is also not too applicable to startups. Most patent-aggressive competitors will take action before the startup's patents have matured to a point where they are useful. And if that unfortunate event happens, startups can always resort to buying patents to use in litigation. Third, patents are useful to demonstrate that the company has value. This is the one reason startups should seek some patent protection—most VCs would like the company to have some IP protection on the company's innovations.

But the key question is how much, and when. Investors are not going to be looking to see if every aspect of the company is covered by a patent. Rather, the startup should focus in the first year on proving its concept and demonstrating that its business plan has value, as well as developing its product or service. There may be several dead ends in that process. Once it becomes clear where the company is going to head to become viable, at that point the company should target the two or three major reasons why its technology or business model is differentiated over what has been done before, and seek very strong patent protection from top-notch prosecution firms focused on the company's core strengths. While patents are important, they are expensive to obtain and it is worth waiting and targeting what turns out to be the valuable assets to protect, rather than rushing into numerous early patent applications that end up having little value."

### **3. Entrepreneurs Don't Focus on How Patents Can Protect Revenue**

---

*...not every neat idea is in fact a business.* - Jim Coffey, McCarter & English

---

[Michael Guiliana](#), partner at Knobbe Martens: "Startups often fall into a trap of investing in patents primarily to protect the "genius" of their inventions. For example, excitement over the cleverness or elegance of a technological solution can be a driving force behind investment in patent protection. Such

excitement can distract a startup from understanding or focusing on how patents can protect revenue and market share. Sophisticated entrepreneurs should map the drivers of their current, anticipated and potential future revenue streams, and work closely with patent counsel to ensure future patent investments are rationally tied to protecting those revenue drivers.”

[Jim Coffey](#), partner in the Emerging Companies practice group at McCarter & English, offers an interesting perspective on this notion: “A big mistake I see many startups make is the failure to realize early on that not every neat idea is in fact a business. You can have a really interesting patent (or even a family of patents), a trade secret or some other unique know how, but still not be able to commercialize your technology in the U.S. or other foreign market. This may be due to obstacles such as unusually large development costs, unique manufacturing challenges or even governmental or regulatory hurdles. However, in each instance, without a practical solution for clearing the obstacle, the startup will more often than not fail. The entrepreneur who thinks ahead from the get-go and develops a strategic patent plan around finding a solution to a unique problem (that exists in a sizeable commercial market) will always win over the less circumspect founder with the “devil-may-care approach” to technology development.”

#### 4. Entrepreneurs Don't Focus Enough On IP Ownership

---

*Defining and documenting appropriate ownership is generally easy to do when done at the right time, but can be difficult to subsequently fix...* - Tom Arno, Knobbe Martens

---

Concern over intellectual property ownership is another of those insights we heard expressed in different ways, each with an important takeaway.

*Gaps in IP Title Chains*

Tom Arno, partner in the Knobbe Martens San Diego office: “A significant but generally avoidable mistake start-up companies make is failing to establish clear chain of title of intellectual property ownership. This problem has only increased as more startups bootstrap themselves as far as possible with outsourced product development services. Defining and documenting appropriate ownership is generally easy to do when done at the right time, but can be difficult to subsequently fix. Potential investors and acquirers will look for clearly documented ownership of all intellectual property by the target company, and it is surprising how often gaps in intellectual property title chains get discovered during due diligence for these transactions. Even if unresolved questions with regard to chain of title may not prevent investment or acquisition, company valuation can be reduced for reasons that in many cases could have been readily addressed if considered earlier.”

#### *Assignment of Pre-Existing IP*

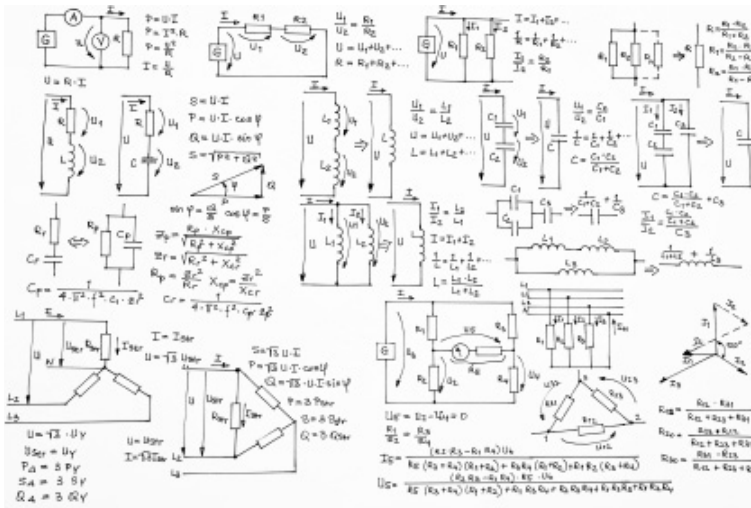

Helen Christakos, chair of the IP practice group at Carr-McClellan:

“Technology development and the formation of key business strategies often begin long before a company is incorporated. Once the company is formed, all of this ‘pre-

existing’ technology and IP must be assigned to the new company. Absent such an assignment, it is likely the individual who creates the technology and IP will continue to own it. If the technology and IP is not assigned to the company, it can create significant problems if the company wants to obtain funding. Angels or VCs will perform legal due diligence on the company, and if it is not clear that the company owns such “pre-existing” technology and IP, this can adversely impact funding and valuation. It is best to assign this “pre-existing” technology and IP to the company at the time of incorporation so the

company can issue stock in consideration of the IP and technology assignment, and it does not have to chase down third parties. However, this can be done retroactively as well.”

### *Written Assignments When Working With Outside Developers*

Chris Sloan of Baker Donelson again: “It’s natural for people to believe that, when they pay for work product such as software, they will own it. Unfortunately, under copyright law, that just isn’t the case, except for work that is done by an employee (in the strict sense) who is acting within the scope of their employment. Most of the time, unless you have an express, written assignment of copyrights, that outside developer you just paid tens of thousands of dollars to will own the software he just developed. And that’s in spite of what both parties may have intended all along. So, get an assignment, and get it in writing.”

### *Agreements with Former Employees*

[Steve Charkoudian](#), chair of Goodwin Procter’s Technology Transactions practice: “Founders or founding teams often neglect to review their employee agreements with former employers. These agreements may give former employers a claim to intellectual property that the founder or founding team is planning to use as a centerpiece of their startup. They often include provisions that say anything you do within the scope of your employment is owned by the company or that anything you do on company time that’s using company materials or machines in creating intellectual property or technology is owned by the company. The most egregious ones that I see include the basic provisions and then say that it’s presumed that anything that is developed within 3 months, 6 months, 9 months, etc. after you leave the company was presumed to have been developed while you worked at the company. So, as a founder or founding team, you really want to look at those agreements to make sure that any former employer doesn’t have a claim to the centerpiece of the technology that the startup was planning on owning.”



*The Fix*

Ashley Dobbs, shareholder at Bean, Kinney & Korman suggests startups should:

1. make an inventory of all their mission critical IP – not just patents, but copyrights, trademarks and trade secrets;
2. make sure the IP is either created as a work for hire for the entity by an employee or under a written agreement, or that the rights are fully assigned to the entity in writing;
3. file the necessary registrations for copyright, trademarks and patents; or
4. take appropriate steps to protect and keep confidential those trade secrets (i.e., security systems, need-to-know access, employee and contractor non-disclosure agreements, etc.).

### **5. Entrepreneurs Don't Take Advantage of 'Track One' Priority Examinations (For Faster Application Process)**

---

*Startups, in particular, are in a special position to jump ahead of the FIFO queue at the USPTO... - Aseet Patel, Banner Witcoff*

---

Aseet Patel is a shareholder at law firm Banner & Witcoff: "Although they are trailblazers in their industries, too many startups acquiesce to the all-too-familiar patent application backlog at the U.S. Patent & Trademark Office. Especially in the software and Internet technology areas, the USPTO can take years before they pick up a newly-filed patent application for examination. Startups, in particular, are in a special position to jump ahead of the FIFO queue at the USPTO. Many startups qualify for the 50 percent discount afforded to small entities (or better yet, for the new 75 percent discount afforded to the newly created micro-entity status). With such steep discounts, for as little as about \$1,000 to \$2,000, a qualifying startup can request the

USPTO's Track One prioritized examination program. We've had great luck with Track One and have been able to obtain granted patents for clients within less than a year, and in one case, in only six months after filing. When time is of the essence and the next round of mezzanine financing is around the corner, don't forget to ask your patent attorney about Track One. It might just be the thing you need to get that patent granted faster and attract the venture capital that your startup needs."

## 6. Entrepreneurs Don't Use Confidentiality Agreements to Protect IP

Lacy Kolo, Ph.D., an associate at Patton Boggs, says: "Startups harm their intangible asset values when they do not use a confidentiality agreement. Because they disclosed their intellectual property to others, they can be estopped from obtaining patent protection, or asserting their IP is a trade secret down the road. All parties should sign a mutual non-disclosure agreement before any discussion on the IP occurs. If IP has already been disclosed, then the startup should make a detailed list of what was disclosed, so an IP attorney can determine if there are any limits on patent or trade secret protection."

## 7. Entrepreneurs Don't Always Select a Distinct and Strong Trademark

And finally, a reminder from G. Henry Welles, partner and chair of the intellectual property group at Best Best & Krieger LLP: "The biggest mistake entrepreneurs make is not taking the time to select, clear and protect trademarks for their businesses and products from the outset. A strong trademark is a valuable asset, and if a business owner inadvertently or intentionally uses a trademark belonging to an existing company, they could end up paying that company all of their profits earned from using that trademark. Entrepreneurs should select a trademark that is distinct and strong; it should not be merely descriptive of the product."

\*

What's on your list of IP mistakes for startups? Send us a note at [news@jdsupra.com](mailto:news@jdsupra.com).

---

**Topics:** [Business Formation](#) [Copyright](#) [First-to-File](#) [Legal Perspectives](#) [Patents](#)  
[Startups](#) [Trademarks](#) [USPTO](#)

**Published In:** [Business Organization Updates](#) [Intellectual Property Updates](#)  
[Science, Computers & Technology Updates](#)

 Report

## CONNECT



**JD Supra Perspectives**

[Contact](#)

JD Supra is a daily source of insights and intelligence for business leaders, media, in-house... [View Profile »](#)

---

### Related Posts

[What Startups Actually Need From Their Lawyers](#)

---

[The One Mistake Startup Entrepreneurs Always Make - A Legal Perspective...](#)

---

### Latest Posts

[7 Intellectual Property Mistakes Startup Entrepreneurs Often Make](#)

---

## Could Bitcoin Make Retail Cybersecurity Obsolete?

---

How'd You Get That Job? Rebecca Signer Roche (@rsigroche), Senior Labor & Employment Counsel at DynCorp International

---

[See more »](#)

---

### Follow JD Supra Perspectives:



### Get Legal Updates by Email



- Business Organizations
- Intellectual Property
- Morning Brief
- Corporate Law Report
- Media Brief
- Weekly Digest

Read latest updates from leading lawyers, delivered to your inbox.

I am a/n [select one]



[Send me updates »](#)

---

[Back to Top](#)

[Home](#)

[About](#)

[Terms & Conditions](#)

[Privacy Policy](#)

[Become a Contributor](#)

[Blogs](#)

[Reporters on Deadline](#)

[Contact](#)

[Jobs](#)

Copyright © 2014 JD Supra, LLC

# What the Supreme Court's Aereo Ruling Might Mean for Cloud Storage Platforms

6/26/2014 by [Rajit Kapur](#) | [JD Supra Perspectives](#)

Like { 2

 4

Tweet 1

Share 3



*...the Court seemed to recognize some of the ways in which a cloud storage platform might distinguish itself from Aereo and from the result reached in this case – beyond merely “not looking like” a cable company.*

Perhaps to the relief of those who saw this case as a potential setback for cloud computing technology, the majority opinion took great pains to emphasize what it was *not* deciding in addition to what it was. And it seems clear that at least one of the many things that was *not* decided was whether a cloud storage platform, such as Dropbox or iCloud, would run afoul of the copyright laws’ protection of the “public performance” right in providing access to video recordings and other copyrighted content stored by its users.

Indeed, in noting what was not being decided, the Court seemed to recognize some of the ways in which a cloud storage platform might distinguish itself from Aereo and from the result

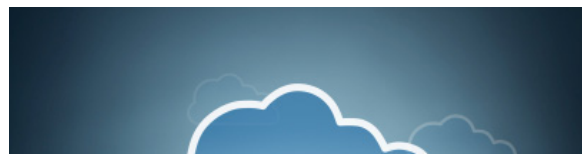

reached in this case – beyond merely “not looking like” a cable company. For example, the Court noted that it has “not considered whether the public performance right is infringed when the user of a service pays primarily for something other than the transmission of copyrighted works, such as the remote storage of content.”



Additionally, in noting that the term “the public” “does not extend to those who act as owners or possessors of the relevant product,” the Court seems to suggest that an instance in which a user of a cloud-based storage platform purchases copyrighted content – and then stores it in the cloud for personal playback on demand – would not implicate the “public performance” right at issue in this case, at least because the user lawfully owns and possesses that content.

Nevertheless, it will be interesting to see what new issues may arise in this case once it returns to the lower court, particularly in view of the concerns raised by Justice Scalia in his dissent, such as how, if at all, the Court’s opinion will affect the legality of Aereo’s “record” function. For now, however, the majority’s limited ruling with respect to Aereo and its technology should not affect – and hopefully will not have a chilling effect on – future development of cloud computing technologies.

\*

**[Rajit Kapur** is an intellectual property attorney at law firm Banner & Witcoff. He has handled a broad range of intellectual property issues in a number of different technical areas, including matters involving computer software, mobile devices, Internet applications, video games, graphical user interfaces, and financial products and services, among others.]

**Topics:** Aereo Cloud Computing Copyright Copyright Infringement Dropbox  
Law Matters Legal Perspectives Public Performance Rights SCOTUS

**Published In:** Communications & Media Updates Intellectual Property Updates  
Science, Computers & Technology Updates

## Don't miss a thing! Build a custom news brief:

Read fresh new writing on compliance, cybersecurity, Dodd-Frank, whistleblowers, social media, hiring & firing, patent reform, the NLRB, Obamacare, the SEC...

*...or whatever matters the most to you.* Follow authors, firms, and topics on JD Supra.

**Create your news brief now - it's free and easy »**





***Law360***



A LexisNexis® Company

News, cases, companies, firms

Search [Advanced Search](#)[News](#)[Rankings](#)[Jobs](#)[Cases](#)[Tracking](#)[Platform Tools](#)[Banner & Wit...](#) | [Sign In](#)[Printable Version](#)[Share Article](#)[Rights/Reprints](#)[Editorial Contacts](#)

## GCs Name Favorite IP Lawyers

By **Kurt Orzeck**

0 Comments

Share us on:

Law360, New York (February 03, 2014, 9:34 PM ET) -- In-house counsel from large and Fortune 1000 companies have named 21 intellectual property lawyers as the most client-service savvy, a distinction they achieved by thoroughly understanding the business impacts of their clients' companies while becoming well-versed in the technical aspects of those businesses.

The 2014 BTI Client Services All-Stars **report** from The BTI Consulting Group Inc. (Wellesley, Mass.) features 330 lawyers who excel at serving their clients, with 21 of them specialize in trademark law, confidential information and other areas of intellectual property.

More than 300 corporate counsel — compared with 240 **last year** — nominated attorneys based primarily on their client focus, but also on their innovative thought leadership, legal skills, outsize value, outstanding results and exceptional understanding of client business.

BTI President Michael Rynowecer told Law360 that the latter quality was most prevalent among IP lawyers who made the list because IP often relates to mission-critical products and processes within a company.

"Understanding that the legal issues could directly affect revenue and new product, bringing that hard-core business-minded approach as well as the technical approach, was a top trend in the nominations," he said.

Bereskin & Parr LLP partner Donald H. MacOdrum — a two-year All-Star who practices in Canada — agreed, saying a technical background is especially helpful for IP lawyers who deal in complex patent-drafting areas such as biotechnology.

"It is important to bring a thorough knowledge of the applicable legal principles, a good understanding of the technical issues and their interplay in the client's business, and a good sense of the business issues in advising clients," he said.

For those IP lawyers who may be lacking technical expertise, they may better serve clients by bringing together different teams from project to project, said Duane Morris LLP partner Sandra A. Jeskie, who has appeared on the BTI survey for the past three years.

"Each lawyer brings unique attributes to any client relationship, and identifying lawyers with appropriate skill sets for each client matter is key to achieving the best result, as well as gaining client confidence and loyalty," she said.

Like Jeskie, who was nominated for her deep knowledge of her clients' companies and solid communication skills, Quarles & Brady LLP partner Gregory P. Sitrick emphasized the importance of looking at his clients' problems from their perspective.

"Once you know what your client wants to do, and you know how your client operates, you can work backward to figure out what action to take," he said. "Sometimes, especially in IP cases, that means acting as a business partner with your adversary rather than treating them as a litigant."

### Related

#### Sections

- Corporate
- Intellectual Property

#### Law Firms

- [TRACK](#) Andrus Sceales
- [TRACK](#) Banner & Witcoff
- [TRACK](#) Bereskin & Parr
- [TRACK](#) Buchanan Ingersoll
- [TRACK](#) Dority & Manning
- [TRACK](#) Duane Morris
- [TRACK](#) Edwards Wildman
- [TRACK](#) Faegre Baker
- [TRACK](#) Fenwick & West
- [TRACK](#) Fish & Richardson
- [TRACK](#) Foley & Lardner
- [TRACK](#) Irell & Manella
- [TRACK](#) Kecker & Van Nest
- [TRACK](#) Morrison & Foerster
- [TRACK](#) Parr Brown
- [TRACK](#) Quarles & Brady
- [TRACK](#) Senniger Powers
- [TRACK](#) Sutherland Asbill
- [TRACK](#) Winston & Strawn

### INTELLECTUAL PROPERTY

#### TOP NEWS

[GCs Name Favorite IP Lawyers](#)[GCs Name Best-Of-The-Best Attys](#)[In-House Counsel Name Client-Friendly Litigators](#)[USPTO Nixes CoreLogic Real Estate Patent In AIA Review](#)[Judicial Bias Doomed \\$1B Qualcomm IP Row, Fed. Circ. Told](#)[2nd Circ. Says Stallone Didn't Steal 'Expendables' Script](#)

#### ANALYSIS

[Fed. Circ. Ruling May Reduce Patent Application Rejections](#)

#### PATENTS

[Ferring Wins Lysteda Patent Trial Against Watson, Apotex](#)[Walgreens Sues Rivals Over Prescription-Refill App Patent](#)

#### COPYRIGHTS & TRADEMARKS

[FilmOn Tries To Jump Into Aereo Supreme Court Case](#)[GoDaddy Can't DQ Judge In Oscars](#)

Fenwick & West LLP partner Rodger R. Cole, based in Mountain View, Calif., said that acting fast and with a sharp business mind is critical to being an IP lawyer, especially in fast-paced IP meccas like Silicon Valley.

"Technology companies make decisions quickly. To give good advice, a lawyer needs to understand the business goals and the risk tolerance of the client," he said. "I learn my client's business before problems arise to identify and respond to issues promptly."

Banner & Witcoff Ltd. attorney Christopher J. Renk said that a deep understanding of his clients' technology and business goals allows him to "bridge communication gaps between engineers and business people, and help extract maximum value out of [his] client's spend on intellectual property protection."

Another BTI All-Star, Edwards Wildman Palmer LLP partner Rory J. Radding, emphasized the importance of cost-effective client services.

"I bring a client-based business focus to my advice by developing an IP strategy that complements and fulfills the client's business strategy in a cost-effective and efficient manner," he said. "When appropriate, I use the tools of litigation, prosecution (design-around) and licensing to reach those goals."

Andrus Scales Starke & Sawall LLP partner Peter Holsen added: "[I] invest significant time and resources staying up-to-date on current technologies, the worldwide economy and the state of the client's industry. I have found that this type of high-quality service marries well with large-scale businesses, including those of Fortune 50 and 500 companies."

Buchanan Ingersoll & Rooney PC executive shareholder Todd R. Walters noted that client-service costs can be cut by turning to post-issuance proceedings, which involve sophisticated decision-makers, a lower burden of proof and lower costs compared with district court litigation.

David J.F. Gross, a partner at Faegre Baker Daniels LLP, said that through his firm's use of alternative fee agreements, it has demonstrated to clients that the firm "is part of the business solution to an IP problem as opposed to a mere transaction cost."

Like other attorneys who serve budget-minded corporations, Foley & Lardner LLP partner Richard S. Florsheim noted the appreciation his clients have for his cost-effective approach to IP litigation.

"Different types of patent infringement cases require different levels of firepower," he said. "A strategic case between competitors seeking to exclude one another from offering product features that are critical to customers requires one level of intensity; a troll case in which my client's only exposure is payment of a modest royalty is an entirely different matter."

Indeed, the management of patent trolls was another oft-cited topic in this year's survey, according to Rynowecer. Winston & Strawn LLP partner Michael A. Tomasulo said he and his clients have prevailed over them by deploying a variety of legal strategies.

"We have been successful with aggressive counter-offensives in cases where the plaintiff's claims were plainly of little or no merit," he said. "This has led to several instances where we convinced the plaintiff to simply 'walk away' from the case."

The IP attorneys named as 2014 BTI Client Service All-Stars are Peter T. Holsen of Andrus Scales Starke & Sawall LLP, Christopher J. Renk of Banner & Witcoff Ltd., Donald H. MacOdrum of Bereskin & Parr LLP, Todd R. Walters of Buchanan Ingersoll &

Cybersquatting Suit

## TRADE SECRETS

Emails Barred As Evidence In DuPont Trade Secrets Case

## LICENSING

Merck To Spend Up To \$2.3B In Ablynx Licensing Deal

Ion Doesn't Owe \$4M In TV Show Licensing Suit, Judge Rules

## ROYALTIES

'Eye Of The Tiger' Band Sues Sony Over Digital Royalties

## PEOPLE

Wiley Rein Adds 3 Ex-BakerHostetler IP Attys In DC

Akerman Opens Chicago Office With Ulmer & Berne Team

## EXPERT ANALYSIS

Patent Prosecution Lessons From Medtronic V. Edwards

How And Why Aereo Got To The Supreme Court

## LEGAL INDUSTRY

Kagan Counts 6 Ginsburg Greatest Hits In Gender Bias Fight

Female Powerbrokers Q&A: Gibbons' Christine Amalfe

Female Powerbrokers Q&A: Holwell Shuster's Dorit Black

Katten's Real Estate Chops Lured Bingham Crew, Atty Says

McCarter & English Scoops Up DC Energy Boutique

Norton Rose Unveils Global Regulation Practice

Heenan Blaikie Plans Restructuring After Atty Departures

Rooney PC, Stephen E. Bondura of Dority & Manning PA, Sandra A. Jeskie of Duane Morris LLP, John S. Letchinger and Rory J. Radding of Edwards Wildman Palmer LLP, David J.F. Gross of Faegre Baker Daniels LLP, Rodger R. Cole of Fenwick & West LLP, Juanita R. Brooks of Fish & Richardson PC, Richard S. Florsheim of Foley & Lardner LLP, Morgan Chu of Irell & Manella LLP, John W. Kecker of Kecker & Van Nest LLP, Michael A. Jacobs and Rachel Krevans of Morrison & Foerster LLP, Terry E. Welch of Parr Brown Gee & Loveless PC, Gregory P. Sitrick of Quarles & Brady LLP, Paul I. Fleischut of Senniger Powers LLP, Peter G. Pappas of Sutherland Asbill & Brennan LLP, and Michael A. Tomasulo of Winston & Strawn LLP.

--Editing by Edrienne Su.

---

#### Related Articles

GCs Pick 19 Topflight IP Attys

Bereskin & Parr To Launch Montreal Outpost On Feb. 1

---

#### Latest in Intellectual Property

Ferring Wins Lysteda Patent Trial Against Watson, Apotex

GoDaddy Can't DQ Judge In Oscars Cybersquatting Suit

USPTO Nixes CoreLogic Real Estate Patent In AIA Review

'Eye Of The Tiger' Band Sues Sony Over Digital Royalties

Fed. Circ. Ruling May Reduce Patent Application Rejections

---

**0 Comments**

[Sign in to comment](#)

[Terms of Service](#)

---

© Copyright 2014, Portfolio Media, Inc. | [Home](#) | [About](#) | [Contact Us](#) | [Site Map](#) | [Site Index](#) | [Jobs](#) | [Careers at Law360](#) | [Mobile](#) | [Terms](#) | [Privacy Policy](#)

**Beta Tools:** [Track docs](#) | [Track attorneys](#) | [Track judges](#)



---

Portfolio Media, Inc. | 860 Broadway, 6th Floor | New York, NY 10003 | [www.law360.com](http://www.law360.com)  
Phone: +1 646 783 7100 | Fax: +1 646 783 7161 | [customerservice@law360.com](mailto:customerservice@law360.com)

---

## High Court Cases May Strike Blow Against 'Patent Trolls'

By **Ryan Davis**

Law360, New York (February 24, 2014, 7:15 PM ET) -- The U.S. Supreme Court will hear oral arguments Wednesday in two cases that could make it considerably easier for courts to impose sanctions on plaintiffs that bring "baseless" patent suits, a shift that attorneys say could cut down on suits by so-called patent trolls.

The petitioners in the separate cases are asking the justices to relax the standard for awarding attorneys' fees to the prevailing party as a sanction when the judge deems a case "exceptional" and to rule that such awards are entitled to deference on appeal, making them difficult to overturn.

If the Supreme Court accepts those arguments, bringing a weak patent case would become a financially risky proposition, and patent trolls would have to think twice before deciding whether they file a suit that could leave them on the hook for the defendants' fees, said Stephen Holmes of Kaye Scholer LLP.

"At the moment, the test is very strict and very rarely applied. It's very hard to get attorneys' fees as a prevailing defendant, especially against trolls," he said. If fees were easier to obtain, "trolls would have their money on the line. At the moment, they're not really at risk."

A greater threat of being hit with attorneys' fees would deter nonpracticing entities from filing patent suits against scores of defendants with minimal due diligence, a common tactic aimed at extracting settlements from accused infringers who want to avoid the cost of litigation, said Charles Shifley of Banner & Witcoff Ltd.

More accused infringers would defend against frivolous suits if they knew they knew there was a good chance their fees would be covered if they prevail, he said.

"The cases have the potential to curb abusive litigation by making it more possible for the accused infringer to recover something," he said.

The two cases deal with Section 285 of the Patent Act, which provides that courts can award attorneys' fees to the prevailing party in a patent case that the court deems "exceptional." Although the cases address different issues, the justices will hear arguments back-to-back on Wednesday.

In one case, the court **agreed to hear** an appeal by Octane Fitness LLC, which beat Icon Health & Fitness Inc.'s claims that it infringed elliptical machine patents but was not awarded attorneys' fees. Octane is asking the high court to review the Federal Circuit's standard that in order to be found exceptional, a suit must be "objectively baseless" and

"brought in subjective bad faith."

That test "so severely limits" the ability of courts to award fees that such awards "are essentially nonexistent," Octane said in its merits brief, arguing that a lower standard would discourage patent trolls and others from filing frivolous suits.

Rudy Telscher of Harness Dickey & Pierce PLC, an attorney for Octane, said that meeting the current standard is "impossible" and a lower standard is needed to protect companies from baseless suits.

"The standard needs to be something that is attainable, so that when a plaintiff brings an unreasonable claim, the defendant is encouraged to defend against that weak case because they know they're going to get attorneys' fees," he said.

In the second case, the justices **agreed to hear** an appeal by Highmark Inc., which had an award of attorneys' fees it won following an unsuccessful suit by Allcare Health Management Systems Inc. vacated by the Federal Circuit. It is challenging the appeals court's standard that fee awards must be reviewed afresh on appeal.

Requiring the Federal Circuit to give deference to awards of attorneys' fees by district courts would make it more likely that they would be affirmed, thus dissuading frivolous suits, Highmark said in its merits brief.

The patentees in both cases said in their briefs that no change in the standards is needed and that changing it would not even address the perceived problems with patent trolls.

Icon told the Supreme Court that it is not a patent troll and is in fact a competitor of Octane, so the troll issue is not present in the case. In any case, it said, lowering the standard would effectively read out the requirement that a case must be "exceptional" in order for fees to be awarded.

Allcare said in its brief that the idea that giving deference to district court fee awards would deter frivolous suits is "entirely unfounded" and amounts to "nothing more than a complaint that fee awards are difficult to obtain — as Congress intended."

Erik Puknys of Finnegan Henderson Farabow Garrett & Dunner LLP, an attorney for Allcare, said the idea that district court decisions on fee awards should be entitled to deference on appeal is contrary to the purpose of the Federal Circuit.

Congress created the court to ensure uniformity in patent law, rather than having the law interpreted differently by 12 regional circuits, he said.

"Under Highmark's proposal, there would not be 12 different views, but hundreds of different views," Puknys said. "Each individual judge could reach his or her own conclusion as to the merits of a legal argument. That's totally against congressional intent."

Some attorneys have warned lowering the standard for attorneys' fees could have implications far beyond patent troll litigation and could make it harder for attorneys to represent their clients in patent cases.

The Federal Circuit should not have to defer to lower courts because it hears the most patent cases and is best suited to determine whether litigation tactics beyond the pale and should be subject to sanctions, said Erik Belt of McCarter & English LLP. Requiring deference would "chill zealous advocacy," he said.

"Whether you're representing a plaintiff or a defendant, as a lawyer, you want to have the flexibility to make aggressive, creative, groundbreaking arguments when called for without

fear of drawing the wrath of the court and having to pay attorneys' fees," said Belt, who filed a brief supporting Allcare on behalf of the Boston Patent Law Association.

Other observers said that although Section 285 allows courts to order attorneys' fees as a sanction against either plaintiffs or defendants for making baseless arguments, the issue is most likely to arise in nonpracticing entity cases.

The federal government has filed briefs supporting the petitioners in both cases, arguing the current standard that makes it difficult to award attorneys' fees has "diminished Section 285's effectiveness as a tool to discourage abusive patent litigation and mitigate injustice suffered by prevailing parties in particular cases."

Holmes says he will be interested to see whether the justices delve into the issue of patent trolls at the oral arguments.

"While Section 285 applies to all patent cases, not just those brought by patent trolls, it will potentially have more impact on cases by patent trolls because those cases often involve weak patents being broadly asserted," he said.

Shifley said that even under a relaxed standard, some patent trolls would still file baseless suits, but empowering defendants who are wrongfully accused to recover attorneys fees would make a difference.

"It would not be a panacea that would end nonpracticing entity litigation, but everything helps," Shifley said.

Highmark is represented by Hogan Lovells and Reed Smith LLP. Allcare is represented by Finnegan Henderson Farabow Garrett & Dunner LLP.

Octane is represented by Harness Dickey & Pierce PLC and Hogan Lovells. Icon Health & Fitness Inc. is represented by Maschoff Brennan Laycock Gilmore Israelsen & Wright PLLC.

The cases are Highmark Inc. v. Allcare Health Management Systems Inc., case number 12-1163, and Octane Fitness LLC v. Icon Health & Fitness Inc., case number 12-1184, both in the U.S. Supreme Court.

--Editing by Jeremy Barker and Philip Shea.

---

All Content © 2003-2014, Portfolio Media, Inc.



---

Portfolio Media, Inc. | 860 Broadway, 6th Floor | New York, NY 10003 | [www.law360.com](http://www.law360.com)  
Phone: +1 646 783 7100 | Fax: +1 646 783 7161 | [customerservice@law360.com](mailto:customerservice@law360.com)

---

## Mentor Graphics Patent Mostly Survives Inter Partes Review

By **Abigail Rubenstein**

Law360, New York (February 25, 2014, 7:44 PM ET) -- The U.S. Patent and Trademark Office has handed a rare victory in an inter partes review to Mentor Graphics Corp., finding that nine claims of a Mentor patent related to prototyping circuits challenged by Synopsys Inc. were patentable and three claims were not.

The dispute before the USPTO's Patent Trial and Appeal Board ends after years of legal wrangling between Mentor Graphics and EVE-USA Inc., which is now owned by Synopsys. Before the board, Synopsys **claimed** that the patent-in-suit, U.S. Patent Number 6,240,376, was anticipated by prior art known as the Gregory patent, U.S. Patent Number 6,132 109.

The PTAB concluded on Feb. 19 that while three of the patent's challenged claims were indeed unpatentable because of the Gregory patent, another nine could stand despite the Gregory patent.

The '376 patent generally relates to the fields of simulation and prototyping of integrated circuit and describes in particular "debugging synthesizable code at the register transfer level during gate-level simulation."

The decision upholding the bulk of Mentor's patent came down the same day as a **decision** that left a single claim of a Proxyconn Inc. software process patent that had been challenged by Microsoft Corp. intact after an America Invents Act review, which some observers said was the first time the USPTO didn't completely wipe out a patent in the inter partes review process.

While 11 claims of Proxyconn's patent — which Microsoft and several computer hardware makers had been accused of infringing — were declared invalid, one of the claims survived the scrutiny of the PTAB, which said the claim wasn't an obvious extension of earlier technological developments Microsoft had cited as grounds for canceling the patent.

In the decision concerning Mentor's patent, which came down on the same day — making it a potentially groundbreaking decision as well — left even more patent claims intact.

"We are pleased to have been able to accomplish another [inter partes review] first in favor of our client Mentor Graphics Corp.," Christopher L. McKee of Banner & Witcoff Ltd. told Law360. "This decision correctly upholds the validity of most of the claims in the trial, including claims that are asserted in parallel patent infringement litigation."

"It was about one year ago that we successfully had a Synopsys petition for inter partes review of another patent involved in the litigation denied in its entirety," he said. "We



believe this earlier decision in [case number IPR 2012-00041] was the first instance of the board denying an IPR petition in its entirety.”

An attorney for Synopsys was not immediately available for comment on Tuesday.

The patent-in-suit is U.S. Patent Number 6,240,376.

Synopsys is represented by William H. Wright and Travis Jensen of Orrick Herrington & Sutcliffe LLP.

Mentor Graphics is represented by Mark E. Miller of O'Melveny & Myers LLP and Christopher L. McKee of Banner & Witcoff Ltd.

The case is Synopsys Inc. v. Mentor Graphics Corp., case number 2012-00042, before the Patent Trial and Appeals Board.

--Additional reporting by Ryan Davis and Dan Prochilo. Editing by Andrew Park.

---

All Content © 2003-2014, Portfolio Media, Inc.



---

Portfolio Media, Inc. | 860 Broadway, 6th Floor | New York, NY 10003 | [www.law360.com](http://www.law360.com)  
Phone: +1 646 783 7100 | Fax: +1 646 783 7161 | [customerservice@law360.com](mailto:customerservice@law360.com)

---

## How The High Court Can Avoid Collateral Damage In Aereo

By **Bill Donahue**

Law360, New York (April 18, 2014, 3:24 PM ET) -- A defeat for Aereo Inc. in its U.S. Supreme Court battle with broadcasters could pose a big threat to the world of cloud computing, the company and others have claimed. With arguments in the case set for Tuesday, Law360 examines if the justices can shut down Aereo without causing problems in the cloud.

The problem is rooted in the Second Circuit's highly publicized 2008 ruling on a Cablevision Systems Corp. cloud-based DVR that made copies for users and then beamed them back to the home. The appeals court found this was merely a "private," rather than a "public," performance under the Copyright Act's transmit clause.

Aereo's system, launched in 2012, was specifically designed to be kosher under the Cablevision ruling: It incorporated banks of tiny remote antennas assigned to individual users that retransmit individual copies of over-the-air programming back to the subscriber.

And it worked: A divided Second Circuit **ruled last spring that**, under the precedent established by the earlier ruling, the court was bound to find that Aereo's transmissions, too, were private performances under the transmit clause — meaning the company could re-air broadcast content without paying royalties.

With the broadcasters **asking the Supreme Court to overturn that decision**, Aereo and others have warned that finding the Cablevision-tailored service illegal would necessarily overturn the earlier precedent itself. And that, they say, would imperil industries that have thrived since Cablevision came down: remote DVRs, remote data storage, and other cloud-based services that allow users to bounce content between the home and a third-party server.

"The broadcasters have made clear they are using Aereo as a proxy to attack Cablevision itself," Aereo founder Chet Kanojia said in a statement last month. "A decision against Aereo would upend and cripple the entire cloud industry."

With arguments kicking off next week, can the justices find a way to walk a fine line if they choose to strike down Aereo? Can they overturn a technology built out of Cablevision without also gutting the earlier ruling or the technology it sanctioned?

The short answer, according to copyright attorneys, is yes — but they'll have to take care to distinguish Aereo from other cloud systems.

**"I tend to think that the justices are going to have get very creative to find in favor of the broadcasters without harming the Cablevision decision,"** said Ross Dannenberg, a

shareholder at Banner & Witcoff Ltd. "They're both DVRs in the cloud."

One way they might do so would be fairly straightforward: distinguishing the already-licensed television programming on Cablevision's cloud DVRs and the lawfully acquired content stored on other cloud services from content consumers are accessing on Aereo that's never been paid for.

"[Cablevision subscribers] were getting a licensed transmission, because Cablevision was paying for licenses from the networks," Dannenberg said. "I think that's a key distinction here."

That's one of the exact arguments the U.S. Department of Justice made last month when **it filed an amicus brief in support of the broadcasters**, which told the justices that a ruling finding Aereo to be an unauthorized "public performance" "need not call into doubt the general legality of cloud technologies."

"The cable company already possessed the necessary licenses to transmit copyright television programs," the feds said. "Respondent's system, however, presents very different issues."

Another step the court could take, if it's concerned about cloud computing services that act as storage lockers, would be to explicitly distinguish in its ruling between the near-live performances of Aereo's service from data being saved on a remote hard drive.

"Cloud computing generally has a lot more to do with storage than transmission," said Jason Bloom, a Haynes and Boone LLP partner. "It's a bit different than what we have here: television that's being broadcast live and then retransmitted."

For a roadmap of the supposed differences between the Cablevision case and the Aereo one, the justices' best source might be Cablevision itself. In a white paper released in December, the cable company blasted the broadcasters' "expansive interpretation" of copyright law but said nothing in the Cablevision ruling required finding Aereo to be legal.

"Aereo's system performs the same basic function as a cable system," Cablevision said, and should be treated as such, forced to pay royalties for rebroadcasting over-the-air content.

"That service bears no resemblance to cloud technologies like Cablevision's RS-DVR, which is simply a remote-storage version of widely accepted recording-and-playback technologies like VCRs and DVRs," the company said of Aereo.

Copyright attorneys agreed, saying the high court could adopt Cablevision's narrow approach and still find Aereo's transmissions to be public performances.

"The court can, and probably should, reach a decision that is focused on whether Aereo's transmissions constitute public performances under the transmit clause," said David Halberstadter, a partner with Katten Muchin Rosenman LLP. "The Supreme Court can render an opinion on this narrow issue without disturbing the Cablevision decision in any way."

Of course, none of this is to say the high court will, in fact, find Aereo's quirky system illegal — that's a different discussion for a different day. While high-profile Aereo backer Barry Diller recently put the odds at 50-50, most top attorneys are hesitant to wager a guess in a complex case lacking much of the political or ideological framing that can often help predict Supreme Court rulings.

But if they do, they'll probably be able to find a way to avoid serious fallout for cloud-

based services, despite the worst prognostications from Aereo and certain others. It's not like they haven't been warned: Earlier this month, the general counsel for the U.S. Copyright Office said the court should avoid a ruling that inflicts "an inadvertent impact on legitimate cloud computing services."

Oral arguments, scheduled for Tuesday, will offer the first indication — albeit an imprecise one — of whether the nine jurists share Aereo's concern over the impact on cloud services.

"The court is always capable of structuring a ruling," said Haynes and Boone's Bloom. "If they were concerned that a ruling against Aereo could affect cloud computing, they could structure the ruling to just apply to what Aereo is doing, rather than to the broader concept."

--Editing by Kat Laskowski and Katherine Rautenberg.

---

All Content © 2003-2014, Portfolio Media, Inc.



**Portfolio Media. Inc.** | 860 Broadway, 6th Floor | New York, NY 10003 | [www.law360.com](http://www.law360.com)  
Phone: +1 646 783 7100 | Fax: +1 646 783 7161 | [customerservice@law360.com](mailto:customerservice@law360.com)

## High Court May Put Brakes On Induced Infringement Suits

By **Ryan Davis**

Law360, New York (April 29, 2014, 1:20 PM ET) -- The [U.S. Supreme Court](#) will hear arguments Wednesday in a case that could limit liability for induced patent infringement, particularly in the area of Internet patents, by undoing a Federal Circuit ruling that opened the door for suits where one company does not perform every step of a patent.

The justices will consider [Limelight Networks Inc.](#)'s appeal of a sharply split [en banc decision](#) from 2012 overturning long-standing precedent that held that induced infringement required a showing that one entity directly infringed by performing all the steps of a patent.

Limelight, which is accused of infringing [Akamai Technologies Inc.](#)'s patent for delivering Web content, maintains that the ruling allowed an unwarranted expansion of infringement liability by holding that companies can be found liable for inducing infringement if they perform some steps of a patented method and induce others, like customers or Web users, to perform the rest.

That argument may resonate with the justices, who have put limits on patent-eligible subject matter in [recent cases](#), said Bradley Hulbert of [McDonnell Boehnen Hulbert & Berghoff LLP](#).

"The Supreme Court seems to have a history of contracting the scope of patent claims," he said. "This is an extension of patent rights that they may push against just as they did with patent eligibility."

Internet-related and other new technologies often involve multiple steps performed by separate entities, so several tech giants like [Google Inc.](#) and [Facebook Inc.](#) have filed amicus briefs expressing alarm that the Federal Circuit's ruling will open them up to induced infringement suits based on the actions of users they have no control over.

"This is an important case because it ultimately gets to the issue of how many people have to be involved to infringe," said H. Wayne Porter of [Banner & Witcoff Ltd.](#)

According to a 6-5 majority of the Federal Circuit, prior precedent holding that induced infringement can only be found when a single entity performs every step of a patent is "wrong as a matter of statutory construction, precedent and sound patent policy."

"If a party has knowingly induced others to commit the acts necessary to infringe the plaintiff's patent and those others commit those acts, there is no reason to immunize the inducer from liability."

In its merits brief, [filed in February](#), Limelight argued that the appeals court had gotten it wrong and that the text of the Patent Act and prior Supreme Court precedent made it perfectly clear that a party can only be liable to induced infringement if another party directly infringed by performing all the steps.

But Akamai argued in its merits brief that the Federal Circuit merely closed a "loophole" that allowed companies to escape liability for induced infringement. Reinstating the previous standard, as Limelight urges, would lead to the "bizarre result" that companies would be liable for infringement if they perform all the steps or induce others to perform them, but not if they perform some of the steps themselves, Akamai said.

The case has prompted a split between the technology industry, which has lined up behind Limelight and urged the high court to overturn the Federal Circuit ruling, and the pharmaceutical industry, which supports Akamai and has argued that the ruling should stand.

In an amicus brief, Google, Facebook and others have said that the Federal Circuit's ruling will "exacerbate the growing problem of high-cost and abusive patent litigation" since it "opens the door to unpredictable potential theories of divided infringement liability based on the actions of an unlimited number of participants" in complex technology markets.

In contrast, [Eli Lilly & Co.](#) said in a brief supporting Akamai that allowing findings of induced infringement when no single party performs all the steps of a patent will help ensure patent protection for pharmaceutical and diagnostic methods where the steps are "sometime unavoidably practiced" by multiple parties, including doctors and pharmacists, at the direction of another entity.

The contrasting positions taken by the industries reflect their different concerns about patent litigation, Hulbert said. Tech companies are worried about being sued by nonpracticing entities wielding patents for online technology, and requiring one entity to perform all the steps of tech patents can help limit their exposure, while pharmaceutical companies are more concerned about recouping their investments in developing patented methods, and foreclosing induced infringement suits if a doctor performs one step could make that difficult.

"I don't think the outcome will be the death knell for either industry, but if the Supreme Court makes inducement harder to show, it will hurt pharmaceutical companies and reassure software companies," Hulbert said.

One wild card is whether the high court will address a separate issue raised by Akamai that the en banc Federal Circuit sidestepped. Akamai argued that Limelight also should have been found liable for direct infringement because it acted jointly with its users, but the appeals court said it did not need to reach that issue because it concluded that Limelight may be liable for induced infringement.

Akamai has urged the Supreme Court to hold that if one party instructs another to perform method steps, it should be found liable for direct infringement. Since the en banc Federal Circuit did not address direct infringement in the opinion being appealed, it's not clear whether the Supreme Court will take up that issue, Porter said.

"That's one of the the things I'll be listening for: how much they seem to focus on that," he said.

The patent-in-suit is U.S. Patent Number [6,108,703](#).

Limelight is represented by Aaron M. Panner, John Christopher Rozendaal, Gregory G. Rapawy and Michael E. Joffre of [Kellogg Huber Hansen Todd Evans & Figel PLLC](#), Alexander F. MacKinnon of [Kirkland & Ellis LLP](#) and in-house counsel Dion Messer.

Akamai and co-petitioner Massachusetts Institute of Technology are represented by Seth P. Waxman, Thomas G. Saunders, Thomas G. Sprankling, Mark C. Fleming, Lauren B. Fletcher, Brook Hopkins and Eric F. Fletcher of [WilmerHale](#), Donald R. Dunner, Kara F. Stoll, Jennifer S. Swan of [Finnegan Henderson Farabow Garrett & Dunner LLP](#), Robert S. Frank Jr. and Carlos Perez-Albuerne of [Choate Hall & Stewart LLP](#) and David H. Judson of the Law Office of David H. Judson.

The case is Limelight Networks Inc. v. Akamai Technologies Inc. et al., case number 12-786, in the U.S. Supreme Court.

--Editing by Elizabeth Bowen and Richard McVay.

All Content © 2003-2014, Portfolio Media, Inc.



---

Portfolio Media, Inc. | 860 Broadway, 6th Floor | New York, NY 10003 | [www.law360.com](http://www.law360.com)  
Phone: +1 646 783 7100 | Fax: +1 646 783 7161 | [customerservice@law360.com](mailto:customerservice@law360.com)

---

## Inducement Ruling Invites Multiparty-Infringement Review

By **Scott Flaherty**

Law360, New York (June 02, 2014, 8:40 PM ET) -- A U.S. Supreme Court ruling that induced infringement can occur only when one party performs every step of a patent will make it easier to fend off inducement claims when the infringement involves multiple actors. But the ruling may not be the final word, attorneys say, since the justices also invited the Federal Circuit to revisit direct-infringement standards in those situations.

In a **unanimous decision** that marks a win for Limelight Networks Inc., the high court justices on Monday overturned the Federal Circuit's **2012 en banc finding** that the company may be liable for induced infringement of a patent for delivering Web content, which is held by Massachusetts Institute of Technology and licensed to Akamai Technologies Inc. Although Limelight performed only some steps of the patent while its customers performed the remainder, the Federal Circuit had found that Limelight could be on the hook for inducing infringement.

The Supreme Court, however, pointed to the Federal Circuit's 2008 decision in *Muniauction Inc. v. Thompson Corp.*, which set out a standard for showing direct infringement if the steps of a method patent are carried out by multiple actors. Justice Samuel Alito, who penned the Supreme Court's opinion, said that in light of *Muniauction*, a party can be liable for direct infringement only if all of the steps of the patent can be attributed to that party, "either because the defendant actually performed those steps or because he directed or controlled others who performed them."

In Limelight's case, the company did not exercise control over the customers who performed some steps of the Akamai patent, meaning Limelight was not liable for direct infringement under the standard laid out in *Muniauction*, according to Justice Alito. He added that, if no one has directly infringed the patent, Limelight could not then be put on the hook for induced infringement.

"There has simply been no infringement of the method in which respondents have staked out an interest, because the performance of all the patent's steps is not attributable to any one person," Justice Alito said. "And, as both the Federal Circuit and respondents admit, where there has been no direct infringement, there can be no inducement of infringement."

Reacting to the Supreme Court's Limelight decision, several patent attorneys told Law360 that the ruling might make it easier for those accused of induced infringement of method patents to defend themselves in cases in which the patent's steps are performed by multiple actors, since the justices have reversed a Federal Circuit decision that expanded liability for inducement in those situations.



"As far as the mechanics of patent law goes, in some ways I think the decision goes against the strengthening of patent holders' rights," said Michael Bennett, associate law professor at Northeastern University. "The ruling will make it harder for a patent owner to make a successful claim for inducement."

But those added defenses against infringement claims in multiple-actor cases may not necessarily last forever. The Supreme Court stopped short of addressing whether the Federal Circuit made the right call in its *Muniauction* ruling — Justice Alito, instead, invited the Federal Circuit to revisit that ruling's direct-infringement standards "if it so chooses." As a result, attorneys say, the ultimate scope of liability in situations in which several parties are involved in the alleged infringement may not yet be settled.

"The battle is really not over," said Benjamin Hsing, a partner in Kaye Scholer LLP's intellectual property practice. "The battle now moves from inducement to direct infringement."

Gene Lee, a Ropes & Gray LLP partner, said the chances that the Federal Circuit does indeed review *Muniauction* could be strong because the issues at the heart of that ruling haven't been addressed in a large number of cases.

"Because it is a relatively young body of law, there is the chance that the Federal Circuit might revisit the standard," he said. "I do think it is potentially primed."

Regardless of whether the Federal Circuit does, eventually, take another look at the rule for direct infringement when multiple parties perform the steps of a method patent, the Supreme Court's decision in *Limelight* on the inducement questions will stand in the meantime. Some attorneys said the ruling likely will affect technology companies, including those with software or network patents in which multiple actors would likely be carrying out the various steps.

"This will have the most profound impact on computer implemented methods ... for any networked, collaborative computer-based systems, because they're naturally more amenable to method claims," Ropes & Gray attorney Michael Kahn said.

Hsing said Monday's high court ruling may also affect the pharmaceutical industry, which relies heavily on "method-of-treatment" patents that may require multiple doctors or a pharmacist to carry out some portion of a patented method.

"There could be a tremendous impact on pharmaceutical patents," Hsing said. "In the pharmaceutical industry, many of the patents are method-of-treatment patents. ... Oftentimes, there's no underlying direct infringement."

Other attorneys say the *Limelight* ruling's effects may be limited.

Banner & Witcoff Ltd.'s Steve Chang explained that, despite the Federal Circuit's 2012 ruling that *Limelight* could have been liable for inducement, most patent attorneys have tried to avoid drawing up method claims involving multiple actors if possible.

"I would say there's probably not going to be a huge impact on our practice," Chang said. "We're still targeting the single-actor and trying to avoid the multiple-actor method claim."

Scott Watkins, a partner with Novak Druce Connolly Bove & Quigg LLP, said that, in his view, most of the patent bar will be well-prepared to fall in line with the Supreme Court's *Limelight* ruling, since the high court simply restored the rules for finding inducement in multiple-actor situations to what they had been before the 2012 Federal Circuit ruling in the case.

"People should be able to follow it quite easily," he said. "It's back to business as usual."

The patent-in-suit is U.S. Patent Number 6,108,703.

Limelight is represented by Aaron Panner, John Christopher Rozendaal, Gregory Rapawy and Michael Joffre of Kellogg Huber Hansen Todd Evans & Figel PLLC, Alexander MacKinnon of Kirkland & Ellis LLP and in-house counsel Dion Messer.

Akamai and co-petitioner Massachusetts Institute of Technology are represented by Seth Waxman, Thomas Saunders, Thomas Sprankling, Mark Fleming, Lauren Fletcher, Brook Hopkins and Eric Fletcher of WilmerHale, Donald Dunner, Kara Stoll and Jennifer Swan of Finnegan Henderson Farabow Garrett & Dunner LLP, Robert Frank Jr. and Carlos Perez-Albuerne of Choate Hall & Stewart LLP and David Judson of the Law Office of David H. Judson.

The case is Limelight Networks Inc. v. Akamai Technologies Inc. et al., case number 12-786, in the U.S. Supreme Court.

--Additional reporting by Ryan Davis. Editing by Jeremy Barker and Richard McVay..

---

All Content © 2003-2014, Portfolio Media, Inc.

[Printable Version](#)[Share Article](#)[Rights/Reprints](#)[Editorial Contacts](#)

# Lawyers Weigh In On Supreme Court's Aereo Ruling

Share us on: [Twitter](#)[Facebook](#)[LinkedIn](#)

Law360, New York (June 25, 2014, 6:44 PM ET) -- The [U.S. Supreme Court](#) on Wednesday ruled that online television streaming service [Aereo Inc.](#) violates copyright law by retransmitting over-the-air programming without authorization. Here, attorneys tell Law360 why the decision in *American Broadcasting Companies Inc. v. Aereo Inc.* is significant.

## Sandra Aistars, The Copyright Alliance



“We welcome the Supreme Court’s decision in the Aereo case. This confirms that authors of work deserve to be compensated for their work. Copyright law needs to remain technology neutral to ensure that a healthy relationship exists between those who create works and those who distribute them. This incentivizes true innovation. The symbiotic relationship between the creative community and those who create technologies and services to distribute their works to consumers has resulted in the launch of countless services and even industries over the years. We also think it is important that the court took efforts to ensure that its opinion would not be read as to cast a shadow over cloud computing services. Cloud computing services are an important and dynamically growing field that existed prior to Aereo and should continue to thrive after this decision.”

## Ian Ballon, [Greenberg Traurig LLP](#)



“This is an important decision and a big win for television companies, in which the court held that a company can be liable for the way it designs its system. At the same time, the court was careful to make clear that it was not holding that a user's conduct in all instances could make a service liable for a public performance, and this is not a case that is likely to retard the development of cloud services — other than services built on Cartoon Network, which had sought to make re-transmit copyrighted content to users without taking a license. This is especially true because the act of transmission already typically implicates the reproduction and distribution rights under the Copyright Act, depending how a given service operates.”

## Michael G. Bennett, Northeastern University School of Law

“Aereo gambled bodily, but poorly. The modifications that Congress made to copyright law in 1976 were more or less designed to deal with situations just like this. Congress explicitly clarified that to ‘perform’ a copyright-protected work meant ‘to show its images in any sequence or to make the sounds accompanying it audible.’ This change made a broadcaster like Aereo and its subscriber-viewers infringers. Congress also said in 1976 that when a broadcaster shows ‘images in any sequence or to make[s] the sounds accompanying it audible,’ it performs publicly. From the beginning, Aereo was legally dead and simply didn't know it.”

## Jason Bloom, [Haynes and Boone LLP](#)



“The Supreme Court’s decision is essentially a death knell for Aereo and the similar but

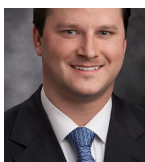

unrelated company FilmOn X. While the court found Aereo to be enough like a cable system to fall within the intent of the Copyright Act, the court certainly did not find Aereo to be a cable system or to be entitled to the type of compulsory license specifically afforded cable systems in the Copyright Act. Aereo therefore has nowhere to go but away. However, the court was careful to limit its ruling to the facts before it, in an effort to minimize any impact on cloud computing, remote storage DVR services, and other technologies. Yet, the ruling is not so clear. While the court did not outlaw cloud computing when it comes to legally obtained content, the ruling could be read to create direct liability for cloud computing companies to the extent their users are storing and retrieving illegally-obtained content. If multiple users of a cloud service are storing and retrieving the same unlawfully obtained bootleg recording, even from different copies at different times, that could cause the cloud companies to be directly liable under the Supreme Court's ruling."

**Felicia Boyd, [Barnes & Thornburg LLP](#)**



"The Supreme Court ruled that online television streaming service Aereo Inc. violates copyright law by retransmitting over-the-air programming without authorization. Aereo had sought to avoid copyright infringement by using elaborate banks of tiny antennas, each assigned to individual users, to capture and transmit signals. Although Aereo tried to distinguish itself from cable companies, it was not successful in doing so. The court held that this system violated copyright law. As a result, Aereo will have to change its business model. In reaching its decision, the court took care not to have an expansive holding discouraging innovation in the world of cloud technology."

**Ross Buntrock, [Arent Fox LLP](#)**

"In failing to recognize the significance of the obvious technological differences that put Aereo outside of the Copyright Act, this is court's majority opens the way for application of the Copyright Act to any number of existing or forthcoming disruptive technologies involving transmission of content to end-user subscribers."

**Dale Cendali, [Kirkland & Ellis LLP](#)**



"At the broadest level, the decision is interesting for its holding's emphasis on the policy and Congressional intent behind the Transmit Clause. At a narrower level, the decision sheds light on the construction of what it means to 'perform a copyrighted work publicly.' Of particular interest, the court draws a line between 'an entity that transmits a performance to individuals in their capacities as owners or possessors' of copyright-protected works, on the one hand, and 'an entity like Aereo that transmits to large numbers of paying subscribers who lack any prior relationship to the works,' on the other. This distinction appears to be intended to address the policy concern raised by Aereo and its amici that the court's decision could have troublesome implications for other innovative technologies, such as cloud computing."

**Ross A. Dannenberg, [Banner & Witcoff Ltd.](#)**



"In Aereo, the Supreme Court took a common sense approach by telling technologists not to put form over substance. This is the second time the Supreme Court has held that you can't manipulate technology to skirt copyright laws. They said it to Grokster, and now they've said it again to Aereo. If you're sitting in a technology development meeting at your company, and someone asks 'How can we deploy this technology to avoid paying a license fee?', I'd think twice about that approach, and make sure that you have legal counsel weigh in on the risks associated with that technology. Despite this, the ruling is not a death

knell for technology development, and in fact reinforces the viability of cloud computing solutions in general. However, just as the Supreme Court has done here, technologists must take a common sense approach when designing new products to determine whether those products will run afoul of copyright law.”

**Seth Davidson, [Edwards Wildman Palmer LLP](#)**



“I’d summarize the decision as a complete victory for the broadcasters with regard to Aereo. However, the majority goes out of its way to describe its holding as ‘limited’ and to base its reasoning on the ‘overwhelming likeness’ of Aereo and traditional cable service and on the fact that Congress’ intent in the 1976 Act was to bring cable systems under the copyright law. Cloud services in general, and even the [Cablevision](#) remote storage DVR, appear to survive under the majority’s limited decision, at least for now — and, reading between the lines, probably in the future in most instances.”

**Anderson Duff, [Wolf Greenfield & Sacks PC](#)**



“This fairly fact-specific and limited ruling makes it clear that a party capturing broadcast signals and retransmitting them online must obtain a license from the content owners. It protects the rights of broadcasters to control their content and negotiate with service providers who may want to retransmit the broadcasters’ content online or otherwise. There are already companies working to do this, and it is probably just a matter of time before companies similar to Aereo are operating on a large scale with the broadcasters’ blessings.”

**Scott Flick, [Pillsbury Winthrop Shaw Pittman LLP](#)**



“The ruling in Aereo is a reminder that complicated cases don’t require complicated decisions. In finding Aereo engaged in public performances of copyrighted works, the decision distills complexities that bedeviled lower courts into a simple result: if it walks like a duck and quacks like a duck, no amount of technology will alter the fact that it is a duck. The biggest surprise was that even the three dissenters had difficulty supporting Aereo’s business model, with Justice Antonin Scalia noting that he shared the Majority’s view that Aereo’s use of broadcast content ‘ought not to be allowed.’”

**Jonathan Hudis, [Oblon Spivak McClelland Maier & Neustadt LLP](#)**

“In Aereo, the Supreme Court found that Aereo’s audiovisual content retransmission and delivery service was a public performance of copyrighted over-the-air television content, and thus infringed upon the copyrights held by the producers, marketers, distributors and broadcasters of that content. The court’s majority opinion attempts to limit the reach of its decision so that it does not unduly impinge upon the growth of new content storage and delivery technologies not presently before the court. On the other hand, the majority’s opinion is of little comfort to new technology providers in making business decisions. Considering the breadth of the court’s decision in interpreting the public performance right, new content storage and delivery providers now must be very careful to ensure that their technologies are not infringing.”

**Neal Katyal, [Hogan Lovells](#), An adviser to the broadcasters.**



“Today’s decision is a sweeping victory for the Broadcast Networks and for American consumers more generally. The court today said that something for nothing is not the American Way, and if people want to transmit and sell other peoples work, they have got to pay for it.”

**Jonathan L. Kramer, [Telecom Law Firm PC](#)**

“The Aereo decision opens a door for broadcasters to demand copyright payments from apartment landlords who provide their tenants with over-the-air TV signals from a rooftop antenna. Like Aereo, a building owner's antenna ‘simply carr[ies], without editing, whatever programs [it] receive[s]’ and the tenant can ‘choose any of the programs he [or she] wished to view by simply turning the knob.’ While building antenna systems might serve just a few tenants in a particular building, Aereo made it clear that even landlord-provided antennas may trigger copyright fees even when copyrighted TV signals are seen by even a single viewer.”

**Bart Lazar, [Seyfarth Shaw LLP](#)**

“The Aereo case is significant for copyright law because it involves the first application of re-transmission and ‘fair use’ provisions relating to the use of a cloud to accomplish the re-transmission of copyrighted material. Since its inception, copyright law has never been able to keep up with technological developments. With the broadcasters winning, the basic structure of copyright law, as flawed as it is, will continue — re-transmission of copyrighted material for commercial purposes is illegal. As a practical matter, businesses will ultimately adapt to paying royalties in much the same way other new, potentially disruptive technologies, like satellite TV and music sharing technologies — adapted, by getting licensed.”

**David Leichtman, [Robins Kaplan Miller & Ciresi LLP](#)**

"The court confirmed that the contrivance of using millions of tiny antennas could not be successfully used to avoid the public nature of Aereo's re-transmissions. In so doing, the court acted consistently with its past approach to new copyright-evading technologies, with substance triumphing over form."

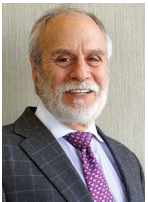
**Harley Lewin, [McCarter & English LLP](#)**

“The Supreme Court properly saw through Aereo’s position that it is merely technology, recognizing that Aereo maintained control over that technology to rebroadcast network content. Just as cable stations and satellite systems pay license fees to rebroadcast, so should Aereo. Had this gone the other way, it would have fundamentally altered the copyright landscape in this digital age, in which consumers binge-watch content via all manner of technology. Digital technology drives sales of copyrighted material, and licensing generates income that incentivizes the development of new delivery methods as well as creation of content. This logical holding clearly warns those who would infringe on protected material.”

**Gina McCreadie, [Nixon Peabody LLP](#)**

“In what the Supreme Court contends is a narrow ruling limited to the application of the Transmit Clause to Aereo’s conduct, its decision reveals a willingness to apply congressional intent and purpose of the Copyright Act, as amended, to new technologies likely not contemplated when the applicable law was enacted. Although the court believes that its decision will not have the effect of ‘discourag[ing] or . . . control[ing] the emergence or use of different kinds of technologies,’ it may have done just that.”

**Antony J. McShane, [Neal Gerber & Eisenberg LLP](#)**

“The Supreme Court rendered its ruling in the Aereo case today, handing down a decision that broadens copyright protection for content providers. For example, as a



result of the ruling, businesses that designed their business strategies to avoid paying license fees for content, based on the new technologies that enabled individual copies of copyrighted works to be made for individual subscribers, will now have to pay royalties to continue to provide their service. Opponents of the decision fear that it will deter such technological innovations in the future.”

**Paige Mills, [Bass Berry & Sims PLC](#)**



“In the short run, this decision will pave the way for television networks to continue to charge significant fees for the transmission of their content. The long term impact of the decision is harder to predict. Which technologies are now infringing because they are too close to ‘cable services,’ and which ones still require ‘volitional’ conduct by the provider of the service? Because uncertainty almost always stifles growth and investment, inventors and investors may be reluctant to create and invest in new technologies if the specter of an injunction for direct copyright infringement looms murkily in the distance.”

**Alina S. Morris, [Christensen O'Connor Johnson Kindness PLLC](#)**



“Aereo is significant because it is a rare opinion by the court on substantive copyright law dealing with technology. However, it is not entirely ground-breaking because regardless of this ruling, Aereo still would not have been allowed to continue its activities. The issue on appeal was denial of preliminary injunction on the theory of Aereo’s direct liability for infringement of the performance right, which it found. The court was not considering here the issue of secondary liability (nor direct or secondary liability regarding infringement of reproduction right). These remaining issues, on remand, will likely still be fatal for Aereo.”

**Bill Munck, [Munck Wilson Mandala LLP](#)**



“The Aereo decision is a win for copyright owners, especially entertainment companies attempting to providing content as the methods for delivering that content continue evolving. By focusing on the simple terms ‘public’ and ‘performance,’ the court protected the incentive to create content by defending the copyright owner’s monetization streams. The business reality is that the absence of such protection would have limited consumer access to content. While tech companies will likely be concerned about the court’s test as to whether new content delivery methods infringe, the court deflected concerns about future technology by noting the holding was limited to Aereo’s specific offering.”

**Joseph T. Nabor, [Fitch Even Tabin & Flannery LLP](#)**



“This decision is significant because it closes a potential exception in the copyright statute that Aereo sought to exploit. By foreclosing that exception, the court provides further guidance on the use of new technologies to circumvent copyright protections, and it further defines the meaning of a public performance as it relates to copyrighted works. Fortunately, the decision is sufficiently narrow that it will not likely have an adverse effect on the use of copyrighted works in cloud-based technologies.”

**Brad Newberg, [Reed Smith LLP](#)**

“In briefs and argument, Aereo and some amici briefs argued that a decision against Aereo could have sweeping negative ramifications for other technologies, including cloud computing. The court went out of its way to clarify that its decision did not consider and would not affect such technologies today. The court focused narrowly on assessing whether Aereo’s service counts as a public performance of over-the-air broadcasts. Ultimately, Aereo never recovered from its difficulty at oral argument to explain why it constructed its system other than to evade copyright law; its inability to

differentiate itself from a traditional cable system sealed its fate.”

**Gregory A. Sebald, [Merchant & Gould PC](#)**



“The Aereo decision is important for the broadcast industry as it maintains their revenues from retransmission fees. The Aereo decision provides clarification on what ‘public performance’ means, but different technologies may present new questions that are not clearly answered by the ruling.”

**Stephen Shaw, [Womble Carlyle Sandridge & Rice LLP](#)**



Image  
Title

“Today’s opinion concludes that the technological machinations of Aereo’s service should be disregarded, and the controlling issue is that Aereo delivers services that ‘are substantially similar to those of the CATV companies.’ The majority in this case appears to be of the opinion that a business model designed by lawyers around perceived legal loopholes still runs afoul of congressional intent behind the ’76 amendments to the Copyright Act. This case leaves unresolved many legal issues related to future tech innovation in the areas of media streaming, remote content delivery, and cloud computing services.”

**Jonathan Steinsapir, [Kinsella Weitzman Iser Kump & Aldisert LLP](#)**



"The Aereo case, in my opinion, returns copyright law to the status quo prior to the Second Circuit's creative interpretation of the Copyright Act in the Cablevision case — a case which got the right result for all the wrong reasons. The Supreme Court went out of its way to limit the decision to the precise technology at issue. Although the decision calls the reasoning of some cases into question — e.g., the Cablevision case and the still pending DISH Hopper case's interpretation of a ‘performance’ — I believe that the results in those cases won't change, for better or worse."

**John I. Stewart Jr., [Crowell & Moring LLP](#)**



“America’s unique system of free broadcasting provides unparalleled programming service. The Copyright Act carefully balanced the interests of creators, distributors and viewers to sustain this service. The court’s decision was plainly driven by the transparency of Aereo’s attempts to evade Congress’s balance. Even the dissent agrees it ‘ought not to be allowed.’ The court’s opinion reinforces the balance, without impinging on new methods of program delivery developed in cooperation with content owners. The court’s analysis of the Transmit Clause and users’ prior rights in stored content may affect the remand on Aereo’s delayed-transmission services, notwithstanding prior court of appeals decisions.”

**Bea Swedlow, [Honigman Miller Schwartz and Cohn LLP](#)**

“There is a message here for innovators whose business models are based on legal loopholes: proceed at your own risk. The court was not persuaded by and was unimpressed with significant technological differences between Aereo’s model and that of cable systems. For example, in the opinion, the court notes that, ‘Viewed in terms of Congress’ regulatory objectives, why should any of these technological differences matter?’ The court clearly understood the differences and merely chose to ignore them. These differences, however, represented the very technological advancements that Aereo created in order to take advantage of loopholes in the Copyright Act. The court also made efforts to ease concerns — raised at oral argument and in amicus briefing — about the impact an adverse decision would have on the fledgling cloud industry. In summary, the court said, ‘We don’t think our opinion puts a target on the backs of the cloud industry; however, we won’t know until a case is brought before us or you can seek attention from Congress.’ Cloud-based companies should take little



comfort from this opinion.”

**Stephen P. Wiman, [Nossaman LLP](#)**



“The Supreme Court’s ruling in Aereo is a blockbuster win for broadcasters but may not have larger implications. The opinion did not enunciate any far reaching rule. Rather it was limited to a fairly prosaic statutory analysis. Amicus briefs filed feared a ruling in favor of broadcasters would stifle the development of new technologies. The court was sensitive to this, emphasizing that its ruling was limited to the facts before it. According to the court, whether other existing and new technologies such as cloud computing run afoul of the Copyright Act must be left for another day and another case.”

**David Wittenstein, [Cooley LLP](#)**



“The court decided the Aereo case correctly. Not only is the court’s decision right on the law, it’s right from a policy perspective. Aereo set itself up as the functional equivalent of a cable system. If Aereo had won, it would’ve succeeded in creating a commercial video distribution business without any of the obligations imposed on other commercial video distributors. In fact, if Aereo had succeeded, cable operators presumably would’ve tried to follow Aereo’s model, which would have undercut the careful scheme Congress has laid out in the Copyright Act and the Communications Act. The case does leave a little unfinished business. The court declined the chance to discuss cloud storage and network DVR, saying that these issues weren’t squarely presented by the case. Those issues remain for another day.”

**Lynda Zadra-Symes, [Knobbe Martens Olson & Bear LLP](#)**



“The Supreme Court’s decision indicates that it is not willing to permit the use of new technology architecture to circumvent the language of the Copyright Act, but will instead assess the commercial realities involved in deciding the scope of the Transmit Clause under the Act. While the court restricted its decision to the specific technological solution utilized by Aereo, the holding is likely to stifle many internet television transmission services by requiring them to cease their transmissions or obtain licenses from broadcasters and content providers. Consumers should expect less choice in providers and an increase in subscription services from those that remain.”

--Editing by Emily Kokoll.

## Related Articles

- [Aereo Decision: When Innovation Looks Like Imitation](#)
- [The Disappointing Oral Arguments In Aereo](#)
- [Broadcasters Strike Out In Aereo Ruling](#)
- [Aereo Fires Back At Networks' IP Claims In Streaming TV Row](#)
- [Justices' Heads In The Cloud During Aereo Hearing](#)

**0 Comments** [Sign in to comment](#)

[Terms of Service](#)

Related

## Sections

- [Appellate](#)
- [Intellectual Property](#)
- [Media & Entertainment](#)

## Law Firms

- [Arent Fox](#)
- [Banner & Witcoff](#)
- [Barnes & Thornburg](#)
- [Bass Berry](#)
- [Christensen O'Connor](#)
- [Cooley LLP](#)
- [Crowell & Moring](#)
- [Edwards Wildman](#)
- [Fitch Even](#)
- [Greenberg Traurig](#)
- [Haynes and Boone](#)
- [Hogan Lovells](#)
- [Honigman Miller](#)
- [Kinsella Weitzman](#)
- [Kirkland & Ellis](#)
- [Knobbe Martens](#)
- [McCarter & English](#)
- [Merchant & Gould](#)
- [Munck Wilson](#)
- [Neal Gerber](#)
- [Nixon Peabody](#)
- [Nossaman LLP](#)
- [Oblon Spivak](#)
- [Pillsbury Winthrop](#)
- [Reed Smith](#)
- [Robins Kaplan](#)
- [Seyfarth Shaw](#)
- [Telecom Law Firm PC](#)
- [Wolf Greenfield](#)
- [Womble Carlyle](#)

## Companies

- [Aereo Inc.](#)
- [Cablevision Systems Corporation](#)

## Government Agencies

-  [U.S. Supreme Court](#)

© Copyright 2014, Portfolio Media, Inc. | [Home](#) | [About](#) | [Contact Us](#) | [Site Map](#) | [Site Index](#) | [Jobs](#) | [Careers at Law360](#) | [Mobile](#) | [Terms](#) | [Privacy Policy](#)

**Beta Tools:** [Track docs](#) | [Track attorneys](#) | [Track judges](#)



Sign up or upgrade to receive a daily report every time a new story is published or case is filed involving this firm.



---

Portfolio Media, Inc. | 860 Broadway, 6th Floor | New York, NY 10003 | [www.law360.com](http://www.law360.com)  
Phone: +1 646 783 7100 | Fax: +1 646 783 7161 | [customerservice@law360.com](mailto:customerservice@law360.com)

---

## 5 Tips For Saving Patents From The PTAB's Ax

By **Ryan Davis**

Law360, New York (August 15, 2014, 8:33 PM ET) -- Most of the patents reviewed by the Patent Trial and Appeal Board to date have been invalidated, but a handful have survived what has become a harrowing process for patent owners.

Here, attorneys who have successfully defended patents before the board share their strategies for keeping patents alive:

### **Put Your Best Foot Forward in the Preliminary Response**

Once an accused infringer or other challenger files a petition seeking to invalidate a patent, the patent owner has the option of filing a preliminary response before the board decides whether to institute a review. In just about every case, the patent owner should take advantage of the opportunity to make the case early for the patent's validity.

In the best-case scenario, the preliminary response can persuade the board not to review the patent at all, said Jon Wright of Sterne Kessler Goldstein & Fox PLLC.

"If you've got a knockout punch because of glaring weakness in the petitioner's case, and you can convince the board not to initiate a trial, that's a huge win," he said.

If a review is instituted, the patent owner's preliminary response can convince the board to only consider some of the arguments raised by the petition, said Christopher McKee of Banner & Witcoff Ltd. That can make it easier to defend the patent and plays into the board's desire to focus on key issues so that the review can be completed within the one-year time limit mandated by Congress.

"If you don't avoid it entirely, you might be able to narrow the trial," he said. "The board has said that they find the preliminary response very useful, and they have every interest in narrowing the scope of the proceeding to keep it streamlined."

The preliminary response lets the patent owner see the board's reaction to its arguments, and if a trial is instituted, "you have an opportunity to put together a full response to address any points where the board didn't go your way and maybe turn the board around," said McKee, who represented Mentor Graphics Corp. in a case where the board affirmed the validity of most challenged claims of the company's patent.

### **Hold the Petitioner's Feet to the Fire**

Both in the preliminary response and after the board has decided to review a patent, the patent owner's goal should be to zero in on the weaknesses in the petitioner's case and aim to convince the board that the high burden of proving the patent invalid has not been met.

That requires a different mindset for attorneys who are used to representing patent applicants during examinations, where they must argue against the examiner's own opinion about why the application should be rejected, said Scott Smiley of the Concept Law Group PA.

According to Smiley, who represented Automated Creel Systems Inc. in a review where the board invalidated some claims of the company's patent but affirmed the patentability of others, the attorney's job is somewhat easier during inter partes review proceedings.

"There, you are arguing to the board why the petitioner's opinion is incorrect," he said. "The petitioner must prove their case by a preponderance of the evidence, and patent owners should constantly hold them to it."

Wright, who represented in ContentGuard Holdings in a review where the board issued a final decision affirming the validity of all the challenged claims of the company's patent, said that the patent owner's goal should be to latch on to any area where the petitioners' invalidity arguments fail to meet the legal burden.

"You're always looking for places where the petitioner has dropped the ball," he said.

For instance, he said that if the petitioner is arguing the patent is obvious, the patent owner should look carefully at the factors for proving obviousness articulated by the U.S. Supreme Court and point out ways the petitioner failed to meet them.

### **Expert Testimony Is Critical**

The PTAB has put strict page limits on filings in inter partes reviews, with the petition, patent owner's preliminary response and the patent owner's response after a trial has been instituted capped at 60 pages.

One way patent owners can get all their strongest arguments before the board is to enlist an expert witness who can submit a declaration with no page limits that expounds on the positions taken in the actual filings, said Charles Wieland of Buchanan Ingersoll & Rooney PC.

"The arguments have to appear in 60 pages, so you want to back them up with an extensive, authoritative expert declaration," said Wieland, who represented Network-1 Security Solutions Inc. in a case where the board affirmed the validity of all of the challenged claims of the company's patent.

Expert declarations are not allowed in the patent owner's preliminary response, only in filings after the trial has been instituted, but attorneys said patent owners should consult with experts early in the case and work closely with them to ensure they are on board with every position the patent owner is taking.

Since the expert will be deposed by the petitioner's counsel, it's not enough for the attorneys to come up with an argument and rely on the expert to expound upon it, said Edward Schlatter of Knobbe Martens Olson & Bear LLP. Instead, the expert must be deeply involved in crafting the positions being taken.

"The expert's position is going to be aggressively attacked, and you need to be confident that they are ready to weather the storm," said Schlatter, who represented Star Envirotech Inc. in a case where the board affirmed the validity of the company's patent. "That is most effective when the expert has a role in developing the case in the first instance."

### **Call In Reinforcements**

If the patent at issue in an America Invents Act review has previously survived invalidity challenges in litigation, the attorneys who worked on the earlier cases can be a valuable resource, Wieland said.

The litigation counsel have lived with the patent for years and fended off invalidity arguments by smart lawyers, so they have a good sense of what the patent does and does not cover, he said. To the extent possible, counsel for the patent owner in an AIA review should enlist their help in defending the patent.

"Bringing in litigation counsel on battle-tested patents is essential to success," Wieland said.

### **Get Ready to Get Technical**

The judges on the PTAB are experts in patent law and technology, so persuading them to uphold a patent's validity necessarily requires the patent owner to make arguments steeped in technical details.

It is often easy to come up with ways in which the invention claimed in a patent is different from the prior art references the petitioner says renders the patent invalid, but those differences will do nothing at all to save the patent if they are not rooted in the language of the patent's claims, Wright said.

"You can find all the differences you want, but if there is not a claimed feature in the patent that cuts to that difference, it's a meaningless distinction, and the patent judges are going to be hyper-focused on that," he said.

While talking in general terms about how the patent differs from the prior art without getting into the specifics of the claim language "might be persuasive in front of a jury or an unsophisticated judge, it's not going to work with the board," he said.

The patent owner should focus closely on the technology involved and lay out a story about, for instance, why it would not be obvious to combine the two prior art references cited by the petitioner, Schlatter said.

"It can't be a surface-level discussion of the references. You need to get into the nuts and bolts," he said.

--Editing by Jeremy Barker and Christine Chun.

---

All Content © 2003-2014, Portfolio Media, Inc.



***Managing Intellectual Property***

## Managing Intellectual Property

The Global IP Resource

### SCOTUS WARY OF UNINTENDED CONSEQUENCES IN LIMELIGHT V AKAMAI

08 May 2014 | Alli Pyrah, New York

**The Supreme Court has to weigh up tough issues in *Limelight Networks v Akamai Technologies* because ruling in favour of Akamai on the issue of induced infringement could lead to a barrage of lawsuits**

In oral arguments in *Limelight Networks v Akamai Technologies* on April 30, the Supreme Court seemed hesitant to create a precedent that one justice worried could lead to "vast numbers of consumers" being sued for patent infringement.

The case concerns the issue of joint infringement - whether two parties can be held liable for violating a patent if they each perform different steps of it.

In this case, Akamai claims that Limelight induced its customers to infringe. Although courts have previously found that induced infringement has occurred when one party has control over other, Limelight does not directly control its customers.

While the justices seemed sympathetic to Akamai's predicament, they expressed concerns that ruling in its favour could create a precedent with unintended consequences. For example, so-called patent trolls have recently begun targeting end-users. Individuals and small businesses tend to have fewer resources to devote to expensive litigation, so they have more of an incentive to settle irrespective of the merits of the case against them.

The case is on appeal from the Federal Circuit, which originally found in a panel hearing that Limelight did not directly infringe the patent. When rehearing the case en banc in August 2012, the Federal Circuit did not reconsider the issue of direct infringement but ruled that Limelight was liable for induced infringement.

Aaron Panner, arguing for Limelight, said that under Section 271(b), a defendant cannot be held liable for induced infringement unless the defendant has deliberately brought about actionable direct infringement under Section 271(a).

Panner said that if the law is to be changed in response to "supposed unfairness in a particular case", that change should be made by Congress, not the courts.

But Chief Justice Roberts seemed sceptical. "Your position makes it pretty easy to get around patent protection, doesn't it?" he asked Panner.

"All you've got to do is find one step in the process and essentially outsource it or make it attractive for someone else to perform that particular step and you've essentially invalidated the patent."

The Supreme Court is not presently considering the issue of direct infringement. During the oral arguments, some of the justices discussed the possibility of doing so next term.

"There was certainly recognition that simply affirming or reversing the Federal Circuit decision might not really address the issue," said Wayne Porter, a senior shareholder of Banner & Witcoff.

"It's an issue that certainly needs some clarification regardless of which side of the issue you are on."

### Ramifications for many industries

Michael Huget, a partner of Honigman Miller Schwartz & Cohn, said the internet has brought about more opportunities for joint infringement. But he said it is also an issue that occurs in the pharmaceutical, medical device and automotive industries.





"My take is that they are inclined to reverse the Federal Circuit because I don't think they were comfortable with the Federal Circuit's ultimate ruling that you can have induced infringement without direct infringement."

How a ruling in Akamai's favour might translate to other industries was an issue that seemed to concern the justices during oral arguments.

Justice Stephen Breyer said he had "no idea" whether Limelight should be liable for patent infringement.

"It sounds simple when you take the invention that you gave, but it doesn't sound simple to me when I start thinking about this one, because this one does seem to me a variation on a very old theme," he said.

Breyer cited the example of a supplier who makes customised materials, some of which use standardised parts, which can be shipped from anywhere in the country, and some of which have to be made by specialists in crowded cities. He said that in such a system, the customer might phone up the standardised parts makers and the customised parts makers.

"And there are not just two steps. There are 87 steps, and many of them involve very innocent things like taking a truck and driving it from one place to another."

Under such a system, there would be various states of knowledge, said Breyer.

"I become very nervous about writing a rule that suddenly might lead millions of people to start suing each other," he said.

To add to the complications, internet commerce also creates potential for joint infringement theories concerning two parties in different countries. "That could be a big issue down the road," said Hugué.

## Ramifications for consumers

Justice McLeod Kennedy expressed concerns that "vast numbers of consumers" could be sued if the court upheld the Federal Circuit's standard.

In response, Seth Waxman, arguing for Akamai, claimed consumers are not sued by patent owners.

"Consumers aren't sued under patent law for infringement, whether there's a single user or multiple users," he said.

"Yet, until we issue the case in your favour," replied Justice Kennedy.

"No, no, not at all," said Waxman. "Quite to the contrary. The consumer - first of all, consumers aren't sued, because under the patent law, under like - under - unlike copyright law, there are no liquidated damages. No-one sues individual consumers."

The Electronic Frontier Foundation (EFF) later took issue with this claim, describing it in a [blog entry](#) as a "bald, and totally false, statement".

"Not only are consumers sued for patent infringement, but recent years have seen an explosion in suits against end-users of technology products," wrote EFF staff attorney Daniel Nazer. "Patent trolls have sued or threatened to sue tens of thousands of end-users."

Nazer cited a [paper](#) by Edward Reines of Weil Gotshal & Manges and Colleen Chien, a Santa Clara University School of Law Associate professor who was appointed by the White House in September to serve as senior advisor for intellectual property in the Office of Science and Technology Policy.

The paper concluded that "mass suits against technology customers have become too common, involving building block technologies like wi-fi, scanning, email and website technologies."

A ruling on the case is expected this summer.

## COMMENTS

AMANDA ROBERT



Display this name  
arobert@bannerwitcoff.com

Please enter a comment here... Please note comments are subject to editorial review.

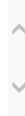

Notify me of follow up comments

Submit

---

## Managing Intellectual Property

THE MATERIAL ON THIS SITE IS FOR FINANCIAL INSTITUTIONS, PROFESSIONAL INVESTORS AND THEIR PROFESSIONAL ADVISERS. IT IS FOR INFORMATION ONLY. PLEASE READ OUR [TERMS AND CONDITIONS](#) AND [PRIVACY POLICY](#) BEFORE USING THE SITE. ALL MATERIAL SUBJECT TO STRICTLY ENFORCED COPYRIGHT LAWS. © 2014 EUROMONEY INSTITUTIONAL INVESTOR PLC. FOR HELP PLEASE [SEE OUR FAQ](#).

---



***Nature Biotechnology***

# Patenting natural products just got harder

The US Patent and Trademark Office (USPTO) on March 4 issued new guidelines with far-reaching consequences for the biotech industry. Following publication of the *Guidance for Determining Subject Matter Eligibility of Claims Reciting or Involving Laws of Nature, Natural Phenomena, & Natural Products*, it is now a lot harder than before for companies to patent natural products, such as antibiotics and therapeutically useful toxins, nucleic acids, peptides and proteins. “Many legal practitioners have raised a concern that the guidelines impose a new test for patent eligibility that is stricter than is required by law,” says Kirsten Grüneberg, attorney at law and partner at Oblon Spivak in Alexandria, Virginia.

The new guidelines draw on two high-profile Supreme Court decisions: *The Association for Molecular Pathology versus Myriad*, which determined that isolated and purified DNA could not be patented (*Nat. Biotechnol.* 31, 663–665, 2013) and *Mayo versus Prometheus*, which ruled that methods of determining optimal drug doses, based on levels of a naturally occurring metabolite were not patent eligible (*Nat. Biotechnol.* 30, 373–374, 2012).

In issuing the new guidance (<http://www.uspto.gov/patents/announce/myriad-mayo.jsp>), the patent office aims to provide clarification for its examiners in light of those

rulings. The new requirement is for a patent claim to show a ‘marked difference’ from a known natural law, material or phenomenon. To illustrate this, the document provides examples of hypothetical patent applications—as a cancer-combating compound isolated from a tropical plant, bacteria with energy-generating plasmids, a method for DNA sequence amplification using specific primers and a diagnostic for neurodegenerative disease based on detecting misfolded protein, and whether or not certain claims directed to these inventions might be patent eligible. The guidance adds the caveat that there are “no bright line rules” to patent eligibility and includes factors that weigh in favor of or against patent eligibility, such as whether or not the invention is “markedly different” from naturally occurring products.

But the breadth of the new patent evaluation is worrying, as it oversteps the Supreme Court rulings. The changes will make it more difficult for patentees to show eligibility and could prove a bonus to those challenging the validity of patents. “[The guidelines] will have a much larger negative impact on the biotechnology and pharmaceutical fields than the Supreme Court contemplated in its recent *Myriad* and *Prometheus* decisions,” says Courtenay Brinckerhoff, a partner at **Foley & Lardner, Washington, DC. “Getting a patent that claims a natural product or**

## IN brief

### Better than breakthrough scheme snags

The UK will allow compassionate use of unlicensed drugs under a new program launched in April by the Medicines and Healthcare products Regulatory Agency. The Early Access to Medicines Scheme is similar to the US breakthrough therapy designation in that it is intended to help fast-track drugs for life-threatening or seriously debilitating diseases with no adequate treatment options. But the UK scheme goes one step further than its US counterpart, by allowing doctors to prescribe drugs still in phase 2 or 3 testing if the agency believes there is a positive benefit-risk balance. One major concern over this scheme is lack of funding. With no government support to provide drugs to patients in the National Health Service (NHS) for free, companies will have to make an upfront investment to participate. “Without centrally funded reimbursement the early access scheme risks being underutilized,” says Steve Bates, CEO of the UK BioIndustry Association. A similar program exists in France, the cohort Authorized Temporary Use program. But the French government pays for compounds used in the program. The UK’s scheme begins with companies submitting an application for a Promising Innovative Medicine designation. Once such a designation is obtained, products will be channeled through a new, collaborative appraisal by the National Institute of Health and Care Excellence (NICE) and a new commissioning scheme in the NHS. For small companies, manufacturing the novel drug and meeting demand may be problematic. Early access programs are also risky because a drug might be killed if it is not effective in seriously ill patients or causes serious side effects. But Bates points out that these schemes are aimed at drug developers already operating in challenging areas, such as rare diseases and gene therapy. “I wouldn’t expect everyone to be interested.” A few days before the UK scheme was announced, the European Medicines Agency launched a pilot project designed to give early approval to products still in development that address an unmet need in restricted patient groups. The principle behind this adaptive licensing pilot is that early phases of data gathering would eventually allow the license to be expanded to different categories of patients. “Adaptive licensing is part of the [early access scheme] mix,” says Bates. “It goes with the grain of thinking that as you accumulate evidence you get a license to do more trials.”

*Nuala Moran, London*

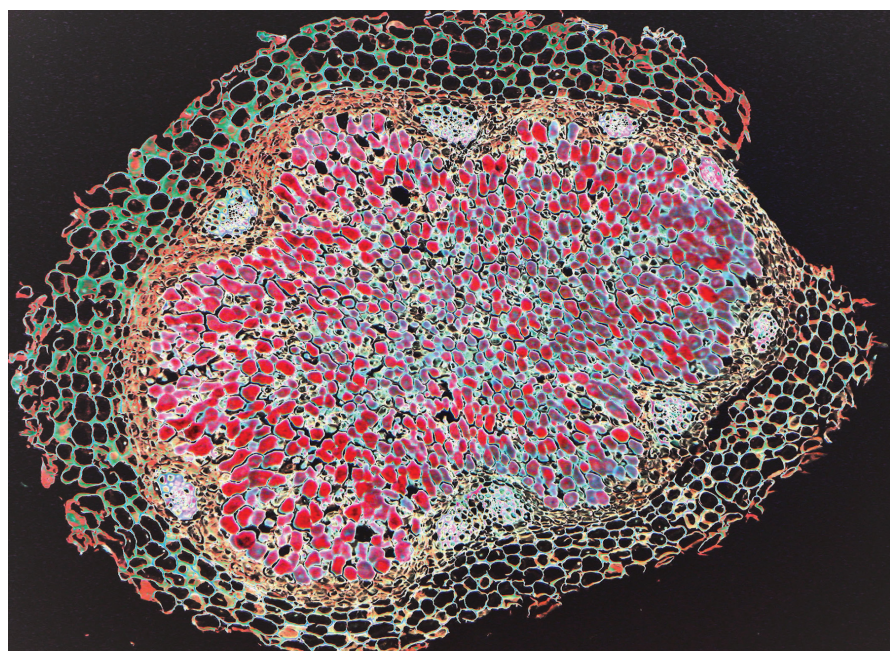

M I (Spike) Walker / Alamy

*Rhizobium* bacteria form a nodule in broad bean root. A 1948 decision rejecting the patentability of *Rhizobium* bacteria mixes for nitrogen fixing has made its way into the recent guidance.

**Box 1** What is still patentable?

Patentees will now need to review their patent portfolios and, together with their patent counsel, assess whether issued or pending claims survive the new patent eligibility guidelines. Some key steps to navigating the guidelines, compiled from our interviewees, follow.

- Ensure that the structure of your invention is sufficiently different from what occurs in nature, for example, by including modifications such as chemical substituents, side chains, point mutations and so on. Ensure that these variations are described in the patent application.
- Consider whether commercial products based on your invention are likely to include components that are not naturally occurring, such as synthetic carriers or adjuvants. Include descriptions of those components in the patent application.
- Work closely with your patent examiner to reach allowable subject matter. Once the initial application has been filed, prepare and file continuations that seek broader subject matter.
- If patent applications have been filed already, be prepared for rejections. Challenge rejected claims through judicial procedures.
- Consider raising the problematic fallout of the guidelines with US Congressional representatives, who might be able to overrule them legislatively.

The points in this box do not constitute legal advice.

includes a natural process will now be more difficult,” says John Iwanicki, a patent attorney at Banner & Witcoff, Boston. “Applicants will probably amend their claims to comply with the guidelines, which could mean that the scope of the invention will shrink,” he adds.

Of particular irk is that the *Myriad* decision centered solely and narrowly on isolated DNA, whereas the guidelines broadly extend to any invention that could include a natural product, compound or material. “This goes way beyond the ruling in *Myriad* and is a total game changer with respect to companies that seek patent protection on isolated natural products,” says Iwanicki. Indeed, Gregory Verdine, founder of Warp Drive Bio, which specializes in natural product drug discovery, is well aware of the new guidelines. “They do not come as a surprise following the *Myriad* decision, but they affect our intellectual property strategy fundamentally,” he says. Of note, carrying out laboratory steps such as isolation, purification or synthetic or recombinant production of a product—even if these steps involve a lot of effort on the part of the scientist—probably won’t boost the chances of patent eligibility, as such steps will not fundamentally distinguish the laboratory product from the natural one.

Some biologics, such as fully human antibodies that match the antibody naturally found in serum, may not pass the new patent eligibility hurdle, but in most cases, a

biologic is structurally different from the naturally occurring product. As a result, the impact of the guidelines on natural product patenting might not be too dramatic. “The vast majority of innovative companies are not in the business of identifying or claiming merely isolated compounds—either DNA or any other molecules,” says Grüneberg. It is also important to remember that a patent that has been issued is presumed valid, and a party that wishes to overturn a granted patent has an uphill struggle. “Invalidity must be demonstrated by a high standard of clear and convincing evidence,” says Iwanicki.

As well as encompassing the *Myriad* and *Prometheus* decisions, the guidelines bring in other Supreme Court cases that also ruled on patent eligibility. These include *Diamond versus Chakrabarty* (from 1980; which held that genetically modified organisms can be patented) and *Funk Brothers versus Kalo Inoculant* (from 1948; which held that a mixture of nitrogen-fixing bacteria is not patent eligible). In a statement to *Nature Biotechnology*, the USPTO notes that “One reason for treating the cases together in the guidance was because both the *Myriad* and *Prometheus* cases relied on precedent set in earlier Supreme Court decisions, including the *Chakrabarty* case, [regarding] whether natural products or naturally occurring things were eligible for patenting.”

But these inclusions widen the scope of the guidelines, raising concerns for biotech

and pharma companies. Drugs described in patent claims as a ‘composition’ of two or more chemicals, that is, a therapeutic compound in a pharmaceutically acceptable carrier would not have raised patent eligibility issues before the new guidelines were issued. Grüneberg points out that by including the *Funk Brothers* case, where a non-naturally manufactured mixture of nitrogen-fixing bacteria was still ineligible for patenting, the USPTO may now apply a similar analysis to pharmaceutical composition claims.

One way of mitigating this potential fallout, says Brinckerhoff, is to claim that at least one component of the pharmaceutical composition is structurally different from that found in nature. “These could include compounds modified with substituents, side chains, point mutations and so on,” she says. “Determining what makes the invention ‘markedly different’ from what occurs in nature will be where the majority of disagreements between applicants and the USPTO will lie, says Grüneberg.

Here it is important to remember that these guidelines are exactly that—guidelines. “They are not law, they have no legal effect and they are not regulations,” says Iwanicki. “Only courts of law can sort out whether patent examiners correctly reject claims using the guidelines.” But he adds that getting the patent is the ultimate goal, and so one needs to fully understand the guidelines when working with the patent examiners to determine what they are willing to allow.

For companies applying for patents, foresight will be critical (Box 1). Obtaining a patent is already a lengthy process, and the guidelines could add to the delay—a problem particularly for small to medium-sized enterprises for which patents are the main asset and a source of confidence for investors.

In practice, what can or cannot be patented is hard to predict. What is certain is that examiner decisions will be challenged both at the patent office and through the courts. This will be costly and time consuming, but ultimately, it is the only way to determine the real effect of the guidelines. “It will take many court decisions to thrash out what the law is on patent eligibility of claims directed to peptides, proteins, naturally sourced antibiotics and nucleic acids,” says Daniel Becker, a patent attorney at Dechert in Mountain View, California. For now, it is wait and see. “The implications of these new guidelines are really unclear at this time,” says Grüneberg.

**Charlotte Harrison** *Canterbury, UK*



***Nature Reviews Drug Discovery***

## PATENT WATCH

## Patentee bears burden of proof when licence agreements are questioned

The licensing of patents in return for a fee or royalties has a key role in drug discovery. Now, the US Supreme Court has ruled in a case that could alter the balance of power between patentee and licensee if a patent licence agreement is disputed or uncertain.

In some situations, such as when the licensee brings out a new product, it may be unclear whether they need to pay royalty fees to the patentee for that product. In such situations, the licensee can file a so-called 'declaratory judgement' action, asking a court to say what the outcome would be if the patent holder were to sue them for infringement. The issue at the centre of the current case was which party — the patentee or the licensee — was required to prove whether or not a patent covers the licensee's products. The Supreme Court decided that it was down to the patent owner to prove that their patents cover the licensee's products.

**"The Supreme Court's decision appears to offer a substantial advantage to patent**

**licensees," says Aaron Bowling, a patent Attorney at Banner and Witcoff, Chicago, Illinois, USA. "Now, because the patent owner bears the burden of proof, patent licensees may now force the patent owner to prove that the already licensed patent does indeed cover the licensee's products, and may do so by filing a declaratory judgement action at a time and venue of their choosing."**

The choice of venue where the parties will resolve a dispute is important, because courts in some locations are considered less patentee-friendly than others.

The case was between the medical device company Medtronic and a group called Mirowski Family Ventures that owns patents related to implantable heart stimulators. The companies have a licensing agreement that permits Medtronic to use certain patents in exchange for royalty payments; however, they disputed whether the licence of two patents was needed for Medtronic to make new cardiac resynchronization

devices. Mirowski accused Medtronic of infringement, so Medtronic sought a declaratory judgement action.

When the case was heard by a US appeals court, it ruled that it was up to the licensee to show that the patent did not cover its products. But the Supreme Court reversed this decision and placed the burden of proof on the patentee. This reversal, it reasoned, was strongly supported by accepted legal propositions. For example, in other litigations (namely, patent infringement cases) it is the patentee who normally has to prove that infringement has occurred. To shift the burden of proof depending on the type of action — that is, declaratory judgement or infringement — could result in a situation where neither party could prevail, and so it would be undecided whether a certain product infringes on a certain patent even after several court cases.

Given that this judgement could favour the licensee, what steps might patent owners now take?

Jim Singer, a patent attorney at Fox Rothschild Pittsburgh, Pennsylvania, USA, explains that a patent holder typically has two legal options when they believe that a licensee isn't paying all royalties that are due. These are to accuse the licensee of breach of contract or to accuse the licensee of patent infringement. (Mirowski followed the latter option.) "This case indicates that a patent holder may want to think twice before making a patent infringement accusation, as the licensee can now file a declaratory judgement and require the patentee to prove that accusation in court," he highlights.

The dispute between Medtronic and Mirowski has been sent back to the appeals court for a decision in line with the Supreme Court's ruling.

**Medtronic versus Mirowski:** [http://www.supremecourt.gov/opinions/13pdf/12-1128\\_h315.pdf](http://www.supremecourt.gov/opinions/13pdf/12-1128_h315.pdf)

Charlotte Harrison



### PATENT ADVISORS

Daniel M. Becker: Dechert, Mountain View, CA, USA.  
 Luke Kempton: Wragge & Co., London, UK.  
 Leslie Meyer-Leon: IP Legal Strategies, Boston, MA, USA.  
 George W. Schlich: Schlich & Co., London, UK.  
 John A. Tessensohn: Shusaku Yamamoto, Osaka, Japan.  
 Philip Webber: Dehns, London, UK.



***World Intellectual Property Review***





## US Supreme Court hears Limelight v Akamai arguments

01-05-2014

The US Supreme Court has heard [arguments](#) on the *Limelight v Akamai* case, which is expected to shed light on whether a defendant can be held liable for patent infringement if multiple parties have performed different steps of the infringement.

The case concerns an Akamai patent that covers a method for delivering content on a web page. According to a court brief, every day one billion people rely on Akamai's services, which support the workings of sites including iTunes, Amazon and eBay.

The court will decide whether the Court of Appeals for the Federal Circuit erred in determining that Limelight may be held liable for inducing patent infringement even though no one party had committed direct infringement.

In an *en banc* decision handed down in 2012, the Federal Circuit upheld a trial court decision that found Limelight was not liable for direct infringement (under 35 USC §271(a)). However, it held that it could be liable for induced infringement (under §271(b)), even though no one party was found liable for direct infringement.

Both Limelight and Akamai filed petitions for *certiorari* to the Supreme Court; Akamai's is still pending.

In March, a group of companies including Google, eBay and Facebook sent a joint *amicus* brief in favour of Limelight, arguing that the Federal Circuit's decision conflicts with the patent statute and prior decisions of the Supreme Court.

Wayne Porter, an attorney from Banner & Witcoff Ltd in Washington DC, said that under the law of "divided infringement", which deals with direct infringement, "there is no liability for direct

infringement of a method claim when an accused infringer performs some claim steps and another performs the other steps, unless that other party is the agent of the accused infringer or acting under the accused infringer's direction or control."

After attending the oral arguments yesterday, Porter told *WIPR* that at least some of the justices "seemed to have trouble" with the Federal Circuit decision: "Justice [Antonin] Scalia made a comment suggesting he might believe the Federal Circuit's decision [on induced infringement] is contrary to the language of the statute."

On the other hand, some of those justices' comments suggested that they thought the issues run deeper, he added.

"For example, Justice Scalia seemed sceptical of Limelight's argument that perceived problems can be avoided by claim drafting. In the same comment where she noted the strength of an argument against the Federal Circuit decision, Justice [Elena] Kagan also pointed out that the decision was an attempt to avoid what the Federal Circuit thought to be an end-run around the patent laws."

He said it is notable that Justice Samuel Alito asked several times if there is any policy reason supporting a finding of no infringement on the facts of the case.

The issue will ultimately come down to whether the court feels that it must address §271(a), he said.

"If the court believes that §271(a) must be addressed, I think it might well grant Akamai's petition, receive further briefing and hear additional argument next term before deciding."

He added: "If the court does not think that it must address §271(a), I think the court would be willing to simply reverse or affirm and indicate that it is up to Congress to fix any perceived problems or gaps in the law."

# **ABOUT THE AUTHORS**



## KATIE L. BECKER

### Attorney

Katie Becker enjoys practicing in many areas of intellectual property law. Katie currently concentrates on patent prosecution and counseling in chemical matters, in addition to design patent and trademark matters. She is part of a team representing one of the world's largest food and beverage companies.

Katie earned a Bachelor's of Science degree in Food Science and a certificate in business at the University of Wisconsin-Madison. As an undergraduate, Katie performed research in food bacteriology. She evaluated the capabilities of bacteria contamination testing methodologies. The results of her research were published in the *Journal of Food Protection* and the *Journal of Food Safety*.

Katie was awarded her J.D. degree and a certificate in intellectual property law from Chicago-Kent College of Law. There, she was an associate editor for the Chicago-Kent Journal of Intellectual Property. She was involved as well with the Intellectual Property Law Society, the Chicago Bar Association, the American Bar Association, and the Institute of Food Technologists.

During her time at Chicago-Kent, Katie was a law clerk at PepsiCo, Inc., assisting in-house counsel on intellectual property-related matters. Additionally, she participated in the Chicago-Kent IP-Patent Clinic and received a grant from the Department of Energy for her research on the effects of incidence and impacts of nanotechnology patents.

In 2014, Katie was named an Illinois Super Lawyers' Rising Star in intellectual property. The Super Lawyers lists represent the top 5 percent of attorneys in each state.

Katie is registered to practice before the USPTO.

### Office

Ten South Wacker Drive  
Suite 3000  
Chicago, IL 60606-7407  
T 312.463.5000  
F 312.463.5001  
kbecker@bannerwitcoff.com

### Education

B.S. 2003, University of Wisconsin  
J.D. 2007, Chicago - Kent College of  
Law

### Bar Admissions

2007, Illinois

### Court Admissions

Supreme Court of Illinois

### Practice Areas

Counseling, Opinions & Licensing  
Design Patents  
Patent Post-Issuance Proceedings  
Patent Prosecution

### Industries

Chemistry & Chemical Engineering



## JORDAN N. BODNER

*Attorney*

Jordan Bodner has extensive experience in all phases of writing and prosecuting complex patent applications in a variety of technical fields including telecommunications, e-commerce, internet-related technology, semiconductors, signal processing, and electro-mechanical devices. Mr. Bodner also regularly provides counseling regarding patent infringement risks and how to reduce such risks, and has represented clients in patent litigation including actions before the International Trade Commission. He presently works with a spectrum of clients ranging from large corporations to individual inventors.

In his previous career, Mr. Bodner worked as an electrical and systems engineer for IBM, Loral Corporation, and Lockheed-Martin Corporation. He has substantial experience in designing and installing large computer systems and networks for customers such as the United States Air Force.

Mr. Bodner has a Bachelor of Science degree in Electrical Engineering from Washington University, a Master of Science degree in Electrical Engineering from the University of Colorado, and a Juris Doctor from George Mason University.

He is admitted to the bars of the District of Columbia, the Commonwealth of Virginia, and the State of North Carolina. Mr. Bodner is also registered to practice before the U.S. Patent and Trademark Office. He is a member of the American Bar Association as well as the American Intellectual Property Law Association.

Mr. Bodner practices in the Washington, DC office of Banner & Witcoff, Ltd.



### Office

1100 13th Street, NW  
Suite 1200  
Washington, DC 20005-4051  
T 202.824.3000  
F 202.824.3001  
jbodner@bannerwitcoff.com

### Education

B.S., 1991, Washington University  
M.S., 1996, University of Colorado  
J.D., 1999, George Mason University

### Bar Admissions

2000, Virginia  
2001, District of Columbia  
2007, North Carolina

### Court Admissions

U.S. Patent and Trademark Office

### Practice Areas

Counseling, Opinions & Licensing  
Litigation  
Patent Prosecution

### Industries

Electrical & Computer Technologies  
Internet, E-Commerce & Business  
Methods



## AARON BOWLING

### Attorney

Aaron Bowling focuses his practice on intellectual property litigation, assisting clients in a variety of industries including biotechnology, sporting goods, and digital music. Aaron provides strategic advice on matters involving utility patents, design patents, trademarks, trade dress, copyrights, and antitrust.

Prior to joining Banner & Witcoff, Aaron served in the Chambers of the Honorable Jimmie V. Reyna at the United States Court of Appeals for the Federal Circuit; which has exclusive jurisdiction over patent-related appeals, and whose decisions are binding precedent throughout the United States. Previously, Aaron worked as an international product owner in the Cellular Therapies and Biosurgery groups of Baxter International, ensuring the safety and efficacy of biotechnological products in compliance with international regulations; and earlier served as a protein engineer at the United States Department of Energy's Argonne National Laboratories.

Aaron earned his Juris Doctor from the George Washington University Law School, where he earned honors as a Thurgood Marshall Scholar and served as an editorial staff member of the American Intellectual Property Law Association (AIPLA) Quarterly Journal. Aaron authored a note in the Summer 2013 Edition of the AIPLA Quarterly Journal entitled "*Just About Equivalent: A Comparative Analysis of the Doctrines of Equivalents in the United States and International Jurisdictions Shows that the Varying Doctrines Are Strikingly Similar*," and also recently contributed as an author in: *Is This License Comparable? Issues Facing Damages Experts When Determining Reasonable Royalties*, published by the University of Texas School of Law, CLE; and *Patent Litigation Strategies Textbook, Third Edition, 2013 Supplement*, published by the American Bar Association.

Aaron earned his Bachelor of Science degree in Molecular and Cellular Biology from the University of Illinois Champaign-Urbana in 2007, and his Master of Science degree in Bioengineering and Biotechnology from Northwestern University in 2008. Aaron is registered to practice before the United States Patent and Trademark Office.

Aaron practices in the Chicago office of Banner & Witcoff, Ltd.



### Office

Ten South Wacker Drive  
Suite 3000  
Chicago, IL 60606-7407  
T 312.463.5000  
F 312.463.5001  
abowling@bannerwitcoff.com

### Education

B.S. 2007, University of Illinois  
M.S. 2008, Northwestern University  
J.D. 2013, George Washington  
University

### Bar Admissions

2013, Illinois

### Court Admissions

U.S. Patent and Trademark Office  
Supreme Court of Illinois  
U.S. District Court for the Northern  
District of Illinois

### Practice Areas

Appellate Litigation  
Copyright  
Design Patents  
Litigation  
Trade Dress  
Trademarks

### Industries

Life Sciences & Pharmaceuticals  
Medical Devices



## ERIN E. BRYAN

### Attorney

Erin Bryan concentrates her practice in patent prosecution and litigation, copyright registrations, and trademark registrations. Her patent practice focuses on the biochemical, chemical engineering, and mechanical engineering arts.

Ms. Bryan also has experience with European Patent Law, and in particular, European opposition proceedings, having interned in Germany.

Prior to attending law school Ms. Bryan worked as a lab technician at a start-up biotechnology company where she conducted her master's thesis research on class I histone deacetylases. She also conducted research on capillary electrophoresis of low explosives while attending Worcester Polytechnic Institute.

At Suffolk University Law School, Ms. Bryan was a member of the Journal of High Technology. While a member of the Journal, Ms. Bryan authored and published an article entitled "Gene Protection: How Much is Too Much? Comparing the Scope of Patent Protection for Gene Sequences Between the United States and Germany." Ms. Bryan was also a 2008-2009 Lead Articles Editor.

Ms. Bryan is an active member in the New Lawyers committee of the Women's Bar Association and the Biotechnology committee of the Boston Patent Law Association. She is also an active member of AIPLA and the ABA.

Ms. Bryan practices in the Boston office of Banner & Witcoff, LTD.



### Office

28 State Street  
Suite 1800  
Boston, MA 02109-1705  
T 617.720.9600  
F 617.720.9601  
ebryan@bannerwitcoff.com

### Education

B.S. 2005, Worcester Polytechnic  
Institute  
M.S. 2008, Worcester Polytechnic  
Institute  
J.D. 2009, Suffolk University

### Bar Admissions

2009, Massachusetts

### Court Admissions

U.S. District Court for the District of  
Massachusetts

### Practice Areas

Appellate Litigation  
Copyright  
Litigation  
Patent Prosecution  
Trademarks

### Industries

Chemistry & Chemical Engineering  
Life Sciences & Pharmaceuticals



## STEVE S. CHANG

### Attorney

Steve Chang's practice focuses on assisting clients with managing their domestic and foreign utility and design patent portfolios. He works with clients to encourage (e.g., via developing inventor incentive programs), collect and cultivate invention disclosures from busy inventors, to help identify core concepts for patentability, and to guide the preparation and prosecution of the corresponding patents with an eye towards compact prosecution and broad patent scope. In addition to patent prosecution, he is experienced in evaluating the strengths and weaknesses of patents for litigation and/or licensing, and his litigation work includes district court trial and appeals to both the U.S. Court of Appeals and the United States Supreme Court.

Steve has handled utility patents in a wide-range of computer and electrical technologies, including Internet services, video games, content delivery networks, user interfaces, wired (e.g., DOCSIS, MoCA, etc.) and wireless (e.g., cellular, wi-fi) communication systems, and many others.

He has also handled hundreds of design patent applications to help his clients protect the novel ornamental appearances of their physical hardware and software user interfaces. Sample representations include work to protect operating system user interfaces, computing hardware and user input devices used by millions of people today.

Outside of work for clients, Steve is an Adjunct Professor at Georgetown University Law School, teaching their course on IP Pretrial Litigation Skills. Steve has also given speeches and presentations for a variety of organizations, such as the IEEE, ABA, Triangle Game Conference and U.S. Navy OGC, and has authored various articles and book chapters in the intellectual property field.

In his spare time, Steve enjoys entertaining his kids, and organizes a weekly pickup game of Ultimate.

Steve received his Bachelor of Science degree in Electrical Engineering from The Ohio State University in 1995, and has been with Banner & Witcoff since receiving his Juris Doctor from the Temple University School of Law in 1998.

Steve is a member of the District of Columbia Bar, and is admitted to practice before the United States Patent and Trademark Office, the United States Court of Appeals for the Federal Circuit, the U.S. District Court for the District of Maryland, and the United States Supreme Court.

Mr. Chang practices in the Washington, D.C. office of Banner & Witcoff, Ltd.



### Office

1100 13th Street, NW  
Suite 1200  
Washington, DC 20005-4051  
T 202.824.3000  
F 202.824.3001  
schang@bannerwitcoff.com

### Education

B.S. 1995, Ohio State University  
J.D. 1998, Temple University

### Bar Admissions

1999, District of Columbia

### Court Admissions

U.S. Circuit Court of Appeals for the  
Federal Circuit  
U.S. District Court for the District of  
Maryland  
U.S. Patent and Trademark Office  
U.S. Supreme Court

### Practice Areas

Appellate Litigation  
Copyright  
Jury Trials  
Litigation  
Patent Prosecution

### Industries

Electrical & Computer Technologies  
Internet, E-Commerce & Business  
Methods



## MARC S. COOPERMAN

### Attorney

Marc Cooperman's practice focuses on intellectual property litigation. He has successfully tried many patent, trademark and copyright cases in courts around the country, and handled many proceedings at the Trademark Trial and Appeal Board. Marc has also assisted clients with resolving disputes through various forms of alternative dispute resolution. He has recently been involved in cases in the consumer products, toy, textile and paper, medical products, and transportation industries. Some examples of published decisions from cases on which Marc has worked include:



- *McAirlaids, Inc. v. Kimberly-Clark Corp.*, 2014 WL 904717 (W.D.Va 2014)
- *Kimberly-Clark Worldwide v. First Quality Baby Products*, 2013 WL 3397871 (M.D.Pa 2013)
- *Kimberly-Clark Worldwide. v. First Quality Baby Products*, 2011 WL 2161072 (Fed. Cir. 2011)
- *Synventive Molding Solutions, Inc. v. Husky Injection Molding Systems*, 2009 WL 3172740 (D.Vt. Oct. 1, 2009)
- *First Quality Baby Prods., LLC v. Kimberly-Clark Worldwide, Inc.*, No. 09-0354, 2009 WL 1675088 (M.D. Pa. June 15, 2009)
- *Arquest, Inc. v. Kimberly-Clark Worldwide, Inc.*, 89 USPQ2D 1751 (S.D.N.Y. 2008)
- *Greenstreak Group, Inc. v. PNA Construction Technologies, Inc.*, 251 F.R.D. 390 (E.D. Mo. 2008)
- *Tyco Healthcare Retail Services AG v. Kimberly-Clark Corp.*, 480 F.Supp.2d 810 (E.D.Pa. 2007)
- *Kimberly-Clark Corp. v. Tyco Healthcare Retail Group*, 456 F.Supp.2d 998 (E.D.Wis. 2006)
- *Outside Box Innovations, LLC v. Travel Caddy, Inc.*, 455 F.Supp.2d 1374 (N.D. Ga. 2006)
- *P.N.A. Const. Technologies, Inc. v. McTech Group, Inc.*, 414 F.Supp.2d 1228 (N.D.Ga. 2006)
- *Peaceable Planet Inc. v. Ty Inc.*, 362 F.3d 986 (7th Cir. 2004)
- *National Steel Car, Ltd. v. Canadian Pacific Railway, Ltd.*, 357 F.3d 1319 (Fed.Cir. 2004)
- *Shen Wei (USA) Inc. v. Kimberly-Clark Corp.*, 64 USPQ2d 1528 (DC NIII 2002)
- *Allied Tube v. John Maneely Co.*, 57 USPQ2d 1329 (D. Ariz 2000)
- *Aero Industries v. John Donovan Enterprises*, 53 USPQ2d 1547 (S.D.Ind.1999)
- *Imperial Toy Corp. v. Ty, Inc.*, 48 USPQ2d 1299 (N.D.III. 1998)
- *Nike, Inc. v. Wal-Mart Stores*, 46 USPQ2d 1001 (Fed.Cir.1998)

Marc frequently speaks and writes about intellectual property litigation. He is an adjunct professor at Northwestern Law School in Chicago and at Georgetown University Law School in Washington, D.C., where he teaches courses on patent and trademark litigation. Marc is a contributing author to the book, "Intellectual Property Law & Interactive Media," published by Peter Lang Publishing Inc. in 2009. Marc has been a contributing editor to the *Federal Circuit Bar Journal*. He has also written a regular column on intellectual property issues affecting the toy industry for *Playthings* magazine. Marc is a past National Chair of the Saul Lefkowitz Moot Court Competition, put on by the International Trademark Association. He also has participated as a facilitator for the Illinois Supreme Court Committee on Professionalism law school program. He is admitted to practice in numerous Federal Courts and the Patent and Trademark Office.

Marc has a Bachelor of Science in Mechanical Engineering (1986) and a Juris Doctor (1989), both from the University of Illinois.

Marc has been featured in several magazines, including a *Chicago Daily Law Bulletin* article when he became managing partner of the firm at age 34. Marc was featured as a "Notable Practitioner" in the Intellectual Property – Illinois section of *Chambers & Partners USA 2014*. Marc was named an IP Star by *Managing Intellectual Property* in 2014 and is also listed in Euromoney's "Guide to the World's Leading Patent Law Practitioners."

Marc Cooperman practices in the Chicago office of Banner & Witcoff, Ltd.

### Office

Ten South Wacker Drive  
Suite 3000  
Chicago, IL 60606-7407  
T 312.463.5000  
F 312.463.5001  
mcooperman@bannerwitcoff.com

### Education

B.S. 1986, University of Illinois  
J.D. 1989, University of Illinois

### Bar Admissions

1989, Illinois

### Court Admissions

U.S. Circuit Court of Appeals for the Federal Circuit  
U.S. Court of Appeals for the Seventh Circuit  
U.S. District Court for the Eastern District of Wisconsin  
U.S. District Court for the Northern District of Illinois  
U.S. Patent and Trademark Office  
U.S. Supreme Court

### Practice Areas

Appellate Litigation  
Copyright  
Counterfeit Goods Seizure  
Jury Trials  
Litigation  
Trade Dress  
Trademarks

### Industries

Medical Devices



## MICHAEL S. CUVIELLO

### Attorney

Michael CuvIELlo concentrates in patent counseling and the preparation and prosecution of patent applications. He assists a wide range of clients manage and grow their patent portfolios, and he understands the varying challenges and needs of different businesses ranging from small startups to global corporations. Mr. CuvIELlo is also experienced in international prosecution, taking into account the nuances of obtaining patent rights in different jurisdictions.

Having years of experience in a broad spectrum of industries, Mr. CuvIELlo is able to provide effective strategies to secure the broadest protection possible for his client's ideas. His technical areas of expertise include semiconductor devices including digital, analog, power, and RF microcircuits; electromechanical devices; renewable energy technologies; computer software applications with concentrations in user interfaces (UIs), and embedded firmware; Internet technologies; and wireless communications.

Prior to joining the firm, Mr. CuvIELlo spent fifteen years working as an engineer for various government agencies, in the private sector, and in academia. Working with NASA and the Department of Defense on both classified and unclassified programs, he developed a wide range of satellite and Space Shuttle electronics, including pyrotechnic ignition systems, full custom flight computers, multi-chip-module devices, and ASICs. In the private sector, he worked for a small startup company developing custom low-power deep sub-micron microelectronic circuits including custom embedded memories for PDAs and cell phones. In academia, during his graduate career, Mr. CuvIELlo was awarded the Microelectronics Innovation and Computer Research Opportunities (MICRO) Fellowship to support his research into digital and mixed signal ASIC semiconductor technology, advance generation wireless/cellular systems such as CDMA, GSM, and other military spread spectrum systems, re-configurable computing, adaptive signal processing, and image processing. Mr. CuvIELlo further developed syllabus and lecturer material for undergraduate and graduate courses in ASIC design. Mr. CuvIELlo is an active member of the IEEE, where he maintains his connection to the engineering and science communities

Mr. CuvIELlo earned a Bachelor of Science degree in Electrical Engineering from the University of Maryland, College Park, and a Masters of Science degree in Electrical and Computer Engineering from the University of California, San Diego. He earned his Juris Doctor from Georgetown University Law Center.

Mr. CuvIELlo practices in the firm's Washington, D.C. office.

*Admitted to practice before the United States Patent & Trademark Office and the State of Maryland. Practice in the District of Columbia is limited to matters and proceedings before federal courts and agencies.*



### Office

1100 13th Street, NW  
Suite 1200  
Washington, DC 20005-4051  
T 202.824.3000  
F 202.824.3001  
mcuvIELlo@bannerwitcoff.com

### Education

B.S., University of Maryland  
M.S., University of California, San Diego  
J.D., Georgetown University

### Bar Admissions

, Maryland

### Court Admissions

U.S. Patent and Trademark Office  
U.S. Circuit Court of Appeals for the Federal Circuit

### Practice Areas

Patent Post-Issuance Proceedings

### Industries



## ROSS A. DANNENBERG

### Attorney

Ross Dannenberg handles a wide-range of intellectual property issues, with experience in Internet, video game, telecommunications, and computer software-related issues. With a background in computer science, Ross has prepared and prosecuted hundreds of patent applications in a variety of technical fields, and has been involved in numerous patent, copyright, and trademark enforcement lawsuits. He has considerable experience with intellectual property protection of video games, including patent, trademark and copyright protection, copyright clearance, licensing, and enforcement of intellectual property rights.

Mr. Dannenberg earned his Bachelor of Science degree in Computer Science from the Georgia Institute of Technology in 1994, and earned his private pilot's license in 1999. Between his undergraduate studies and law school, Mr. Dannenberg was an Information Systems Manager for Carnival Cruise Lines, where he was responsible for all facets of computer and network use, training, and administration aboard a cruise ship. He earned his Juris Doctor from The George Washington University Law School in 2000, where he was a member of The Environmental Lawyer legal journal.

Mr. Dannenberg is a founding member of the Video Game Bar Association, and was the founding Chair of the American Bar Association's (ABA) IP Section Committee on Computer Games and Virtual Worlds. Mr. Dannenberg is the Editor-in-Chief of the Patent Arcade website, is the editor and an author of The American Bar Association's Legal Guide to Video Game Production, published by the ABA in 2011, and is an executive editor of Computer Games and Virtual Worlds: A New Frontier in Intellectual Property Law, published by the ABA IP Section in 2010. Mr. Dannenberg is a Lifetime Fellow of the American Bar Foundation, and is an adjunct copyrights professor at George Mason University School of Law.

Mr. Dannenberg was named to Washington D.C. Super Lawyers in 2013 and 2014, and *Managing Intellectual Property's* IP Stars in 2013.

Mr. Dannenberg's representative clients include multinational software, networking, and telecommunications companies, multiple video game companies having user bases of over 20 million users, video game developers and publishers of various sizes, and emerging technology companies.

Mr. Dannenberg practices in the firm's Washington, D.C. office.



### Office

1100 13th Street, NW  
Suite 1200  
Washington, DC 20005-4051  
T 202.824.3000  
F 202.824.3001  
rdannenberg@bannerwitcoff.com

### Education

B.S. 1994, Georgia Institute of  
Technology  
J.D. 2000, George Washington  
University

### Bar Admissions

2000, Virginia  
2001, District of Columbia

### Court Admissions

Supreme Court of Virginia  
U.S. Circuit Court of Appeals for the  
Federal Circuit  
U.S. Court of Appeals for the Fourth  
Circuit  
U.S. District Court for the Eastern  
District of Virginia  
U.S. Patent and Trademark Office

### Practice Areas

Copyright  
Design Patents  
Litigation  
Patent Prosecution  
Trademarks

### Industries

Electrical & Computer Technologies  
Internet, E-Commerce & Business  
Methods



## JOHN M. FLEMING

### Attorney

John Fleming concentrates on preparing and prosecuting utility and design patent applications in a variety of technical fields while participating in litigation matters, client counseling, and a wide variety of opinion work. Mr. Fleming's technical areas include telecommunications, Internet-related and private network technology, semiconductors, e-commerce, digital/electronic handwriting, color management, graphical user interface systems, financial security and authentication, application programming interfaces, and computer-relation technologies involving hardware, software, and firmware. In addition, Mr. Fleming has an extensive amount of design prosecution experience and development, including various hardware in addition to computer interfaces and icons. Mr. Fleming has filed and prosecuted hundreds of design applications from initial prototypes to commercially available products. With a practical based background in electrical engineering, Mr. Fleming has experience in all phases of writing and prosecuting complex patent applications in a variety of technical fields.

Mr. Fleming's engineering accomplishments are based in part on his applied experience as an electrical engineer for Schlumberger Industries, RMS. As both an application and product engineer, his activities included design, implementation, and maintenance of various power measurement systems and structures utilizing a variety of telecommunication and power measurement technologies. Mr. Fleming also gave instruction and training on use and operation of product and software packages, and handled on-site restoration and maintenance of system and component failures, including a project at the launch of deregulation of the electric utility market.

Mr. Fleming serves as Associate Professorial Lecturer in the Mechanical and Aerospace Engineering Department (MAE) at The George Washington University teaching Patent Law for Engineers. Taught to undergraduate and graduate level science-based students, this course covers all major aspects of intellectual property including patents, trademarks, copyrights and related matters and is one of three courses that together comprise a Patent Law Option offered through The George Washington University's School of Engineering and Applied Sciences (SEAS), the first of its kind in the country. Mr. Fleming, along with other faculty at The George Washington University, co-created the Patent Law Option and began offering courses in this program in early 2006.

Mr. Fleming earned his Bachelor of Science degree in Electrical Engineering from Clemson University with concentrations in circuit design and configurations and fiber optic technologies. He earned his Juris Doctor from The Catholic University of America Columbus School of Law in 2002.

Mr. Fleming is admitted to the bars of the District of Columbia and the Commonwealth of Virginia, and is registered to practice before the U.S. Patent and Trademark Office. He is also a contributor to the American Bar Association Section of Intellectual Property Law's Patent Litigation Strategies Handbook.

Mr. Fleming practices in the Washington, D.C. office of Banner & Witcoff, Ltd.



### Office

1100 13th Street, NW  
Suite 1200  
Washington, DC 20005-4051  
T 202.824.3000  
F 202.824.3001  
jffleming@bannerwitcoff.com

### Education

B.S. 1996, Clemson University  
J.D. 2002, Catholic University

### Bar Admissions

2002, Virginia  
2005, District of Columbia

### Court Admissions

U.S. Patent and Trademark Office

### Practice Areas

Counseling, Opinions & Licensing  
Design Patents  
Litigation  
Patent Prosecution

### Industries

Electrical & Computer Technologies  
Internet, E-Commerce & Business  
Methods



## SHAWN P. GORMAN

### Attorney

Shawn Gorman has experience in a range of intellectual property issues, primarily in complex patent matters.

Mr. Gorman prepares and prosecutes patent applications in a wide variety of technology areas, including the electronic arts, business methods, mechanics and biotechnology. Specifically, he has prepared and prosecuted applications relating to graphical user interfaces, cellular technologies, integrated business systems and models, video gaming systems, online gaming systems, as well as interleukins, medical diagnostics and laboratory devices.

Mr. Gorman often works directly with the firm's clients to combine multiple forms of intellectual property protection. In this regard, he obtains domestic and international patent rights to protect the client's core technology and business methods, trademark protection, and enforcement of those rights through licensing and purchasing agreements. Shawn works closely with foreign attorneys throughout the world to determine the best strategies for multiple jurisdictions. He has assisted in the training of foreign attorneys in U.S. patent laws and continually uses this experience to further his knowledge of international laws and best practices.

When litigation has become necessary, Shawn has handled the various aspects of patent litigation. He is presently a member of a trial team for a Fortune 500 medical device company as well as member of a trial team defending a leading manufacturer of VoIP telephony devices.

Before joining Banner & Witcoff, Mr. Gorman was with the patent division of CIBA Vision. He also served as an extern for Wyeth Pharmaceuticals. Mr. Gorman earned his graduate degree from the University of Florida College of Veterinary Medicine, where he was awarded the Phi Zeta Excellence in Master's Studies Scholarship for his work investigating an experimental patent-pending product. The results of his graduate worked were utilized to satisfy the best mode requirement of U.S. patent laws.

Mr. Gorman is a contributing author for *The American Bar Association's Legal Guide to Video Game Production*, published by the ABA in 2011. Mr. Gorman has also written articles in such publications as the *Journal of the American Veterinary Medical Association*, *Theriogenology*, and the *Pierce Law Review*.

Mr. Gorman earned his Juris Doctor degree from the Franklin Pierce Law Center, where he was Senior Staff Editor of the *Pierce Law Review*, successfully contended in the Jessup International Law Moot Court and was honored to receive the Rapee Intellectual Property Scholarship. He is admitted before the United States Patent and Trademark Office.

Mr. Gorman practices in the Chicago office of Banner & Witcoff, Ltd.



### Office

Ten South Wacker Drive  
Suite 3000  
Chicago, IL 60606-7407  
T 312.463.5000  
F 312.463.5001  
sgorman@bannerwitcoff.com

### Education

B.S. 1998, University of Florida  
M.S. 2001, University of Florida  
J.D. 2004, Franklin Pierce Law Center

### Bar Admissions

2005, Illinois

### Court Admissions

U.S. District Court for the Northern  
District of Illinois

### Practice Areas

Counseling, Opinions & Licensing  
Litigation  
Patent Prosecution  
Trademarks

### Industries

Chemistry & Chemical Engineering  
Electrical & Computer Technologies  
Internet, E-Commerce & Business  
Methods  
Life Sciences & Pharmaceuticals  
Medical Devices



## R. GREGORY ISRAELSEN

### Attorney

Greg Israelsen focuses on intellectual-property litigation, representing clients in patent disputes related to electrical, computer-hardware, computer-software, and mechanical arts. He also represents clients in copyright- and trademark-infringement actions.

During law school, Mr. Israelsen worked as a summer associate at the firm. He also clerked for a patent boutique, where he drafted and prosecuted patent applications for a Fortune 50 client and was part of a litigation team in a trademark-infringement action for a nationwide food franchise.

Before law school, Mr. Israelsen formed his own company and developed smartphone apps for mobile platforms. Several of his apps won awards from a well-known smartphone manufacturer and were featured on a top technology website.

Mr. Israelsen studied Electrical Engineering at the University of Illinois at Urbana-Champaign and at Brigham Young University. He earned a Bachelor of Science, *with University Honors*, from Brigham Young University. He earned a Juris Doctor, *cum laude*, from the J. Reuben Clark Law School at Brigham Young University. In law school, he served as Vice President of the Student Intellectual Property Law Association, Vice President of the Student Bar Association, Senior Editor on the *Brigham Young University Law Review*, and Managing Articles Editor on the *BYU Journal of Public Law*. He was a member of the IP Moot Court, Vis International Commercial Arbitration, and Moot Court teams. He also won the local Giles S. Rich IP Moot Court competition two years in a row, going on to represent his school at the regional competition in California. And he received the Faculty Award for Meritorious Achievement and Distinguished Service and the John S. Welch Award for Outstanding Legal Writing.

Mr. Israelsen has extensive international experience. He lived for several years in Hong Kong and Caracas, Venezuela, and has traveled all over the world. He is fluent in spoken Cantonese and conversant in Spanish.

Mr. Israelsen practices in the Washington, DC office of Banner & Witcoff, Ltd.



### Office

1100 13th Street, NW  
Suite 1200  
Washington, DC 20005-4051  
T 202.824.3000  
F 202.824.3001  
risraelsen@bannerwitcoff.com

### Education

B.S. 2009, Brigham Young University  
J.D. 2013, J. Reuben Clark Law  
School

### Bar Admissions

2013, Illinois  
2014, District of Columbia

### Court Admissions

Supreme Court of Illinois  
U.S. Court of Appeals for the District  
of Columbia  
U.S. Patent and Trademark Office

### Memberships

American Bar Association (ABA)

### Practice Areas

Appellate Litigation  
Copyright  
Counseling, Opinions & Licensing  
Counterfeit Goods Seizure  
Jury Trials  
Litigation  
Patent Prosecution  
Trade Dress  
Trade Secrets  
Trademarks

### Industries

Electrical & Computer Technologies  
Internet, E-Commerce & Business  
Methods



## JOHN P. IWANICKI

Attorney

John P. Iwanicki is a registered patent attorney with 25+ years of experience analyzing intricate legal issues from a cutting edge perspective in procuring and enforcing intellectual property rights in the chemical, life sciences and biotechnology industries. Start-ups and established companies alike rely on John to understand their business objectives when designing strategies to achieve market exclusivity and freedom to operate.

John is the rare combination of a patent litigator and patent prosecutor. Possessing both skill sets, John brings a perspective unique in the industry to obtaining and enforcing patents. John works hand-in-hand with clients to develop and manage pragmatic patent portfolios and to advise clients on the patent portfolios of others when making licensing or investment decisions. Recognizing that a patent can be both a sword and a shield, John has both enforced patents and defended allegations of patent infringement in federal court.

A conference organizer and presenter in China, John has lectured to Chinese scientists, business executives, representatives of SIPO and students in Beijing, Shenzhen and Shanghai on issues of United States patent law practice and procedure. John is also a member of the American Chemical Society.

John has been named a Massachusetts Super Lawyer annually since 2004 and was named a Life Sciences Star by LMG Life Sciences for 2012-2013. John has also been named an IP Star by Managing Intellectual Property for 2013 and has been named by Intellectual Asset Management 1000 as one of "The World's Leading Patent Practitioners" for 2013.

John practices in the Boston office of Banner & Witcoff, Ltd.

A frequent lecturer, teacher and author on intellectual property, John's recent speaking engagements and publications are below:

### Speaking Engagements

Speaker, Gene Patenting Pre- and Post-Myriad, Haut Conseil des Biotechnologies, Paris, France, April 29, 2014.

Speaker, Obviousness Post Myriad and Prometheus: A Practical Approach to Prosecution, IP Leadership Forum, New Delhi, India, January 9, 2014.

Speaker, Protecting protein and peptide related inventions, PepCon-2013, Suzhou, China, March 21, 2013.

Speaker, Demystifying the Current Obviousness Standard and Its Implications for Biotech Patenting, American Conference Institute's Biotech Patents Conference, Boston, MA, November 29, 2012.

Speaker, Protein and Peptide Related Inventions, PepCon-2012, Beijing, China, March 25, 2012.

Speaker, The America Invents Act, Pharma IPR Conference, Mumbai, India, February 1, 2012.

Speaker, Preparing for a Radical Overhaul of the U.S. Patent System: The Impact of Reform on Biotech Patent Strategies, American Conference Institute's Biotech Patents Conference in Boston, December 1, 2011.

Speaker, Patenting Your Medicinal Chemistry Invention, Chinese National Medicinal Chemistry Symposium, Guangzhou, China, November 20, 2011.

Speaker, Patenting of Antibodies, American Conference Institute's Biotech Patents Conference, Boston, MA, December 1, 2010.

Speaker, Patenting of Antibodies, American Conference Institute's Biotech Patents Conference, Boston, MA, November 30, 2010.



#### Office

28 State Street  
Suite 1800  
Boston, MA 02109-1705  
T 617.720.9600  
F 617.720.9601  
jiwanicki@bannerwitcoff.com

#### Education

B.S. 1984, Chemistry, Boston College  
M.S. 1986, Physical Chemistry,  
University of California, Irvine  
J.D. 1990, Suffolk University

#### Bar Admissions

1990, Massachusetts  
1991, District of Columbia

#### Court Admissions

U.S. Court of Appeals for the District  
of Columbia  
U.S. Court of Appeals for the Federal  
Circuit  
U.S. Court of Appeals for the First  
Circuit  
U.S. District Court for the District of  
Massachusetts  
U.S. Supreme Court

#### Memberships

American Chemical Society  
IPO Pharmaceutical Issues Committee

#### Practice Areas

Counseling, Opinions & Licensing  
Jury Trials  
Litigation  
Patent Prosecution

#### Industries

Chemistry & Chemical Engineering  
Life Sciences & Pharmaceuticals

Speaker, IP Basics, Zhongguancun Haidian Science Park Beijing, Beijing China, September 10, 2010.

Speaker, US Patent Practice, The Patent Information Annual Conference of China (PIAC China), hosted by the State Intellectual Property Office, Beijing China, September 9, 2010.

Speaker, Safe Harbor Provision of 35 USC sec. 271(e)(1), American Conference Institute's Hatch-Waxman Bootcamp in Boston July 19-20, 2010.

Speaker, "IP Issues Relating to Therapeutic Oligonucleotides and Peptides," IBC LifeSciences TIDES Conference, Boston, MA, April 28, 2010.

Hosts a Roundtable Discussion, "The Practical Aspect of Patents as Strategic Business Tools," Cambridge Healthtech Institute's 9th Annual Peptide and Protein Conference, San Diego, CA, January 12, 2010.

Speaker, "Maximizing Your Global Patent Strategy," 5th International Conference on Corporate Intellectual Property Strategy, Zhengzhou, Henan Province of China, October 28-30, 2009.

Guest Lecturer, "Making Medicine," Harvard University, Cambridge, MA, June 22, 2009.

Speaker, "Freedom to Operate and Injunctions under US Law," Unitalen Law Firm, Beijing, China, June 5, 2009.

Keynote Speaker, "Global Patent Strategies," International Symposium on Drug Discovery and Intellectual Property, Suzhou, China, June 2, 2009.

Short Course Lecturer, "Intellectual Property as it Relates to Antibodies", Cambridge Healthtech Institute's 5th Annual PEGS Protein Engineering Summit, Boston, MA, April 5, 2009.

Chair and speaker, "Biotechnology and Technology Transfer," BIT Life Sciences 3rd Annual Protein and Peptide Conference, Beijing, China, March 23, 2009.

Short Course Lecturer, "Intellectual Property as It Relates to Peptides and Proteins ad Therapeutics and Diagnostics", Cambridge Healthtech Institute's Peptide and Protein Week, San Diego, CA January 11, 2009.

Keynote Speaker, Beijing International Workshop on Drug Design and IP Protection in Beijing, China, October 23-24, 2008.

Speaker and Chair, BIT's 5th Annual International Conference on Drug Design Science and Technology in Beijing, China, October 18-22, 2008.

Speaker, "We've Got Patents. How Can We Be Sued"?, BIT's 1st Annual Protein and Peptide Conference in Shenzhen, China, April 22-24, 2008.

Speaker, "Avoiding IP Surprises"; Cambridge Healthtech Institutes 14th Annual Molecular Medicine Tri-Conference in San Francisco March 25, 2008.

Speaker, Protein and Peptide Patent Law, Cambridge Healthtech Institute's Peptide and Protein Week, San Diego, CA January 12, 2008.

Speaker, "US Pharmaceutical Patent Law", State Intellectual Property Office of the People's Republic of China pharmaceutical conference in Beijing October 17-19, 2007.

Speaker, "Freedom to Operate: Analysis and Opinions for Pharma and Biotech Patents, Pharma/Biotech Patent Boot Camp, American Conference Institute, San Francisco, September 18-19, 2007.

Speaker, Protecting Start-Up Intellectual Property; CELLutions Summit, Cambridge Healthtech Institute, Boston MA, August 20, 2007.

Speaker, Written Description and Enablement in Biotechnology related cases: Current Developments in Federal Circuit Caselaw, American Conference Institute, Palo Alto, California, April 18-19, 2007.

Speaker, "Intellectual Property Issues for Emerging Technology Companies"; Cambridge Healthtech Institutes 13th Annual Molecular Medicine Tri-Conference in San Francisco February 27, 2007.

Speaker, "Nanotechnology", South Shore Science Center, January 27, 2007.

Speaker, "Peptide and biomarker related Inventions"; Cambridge Healthtech Institute's 6th Annual Peptide-Protein Information conference in San Diego January 9-12, 2007.

Speaker, "Corporate Counsel Seminar" in Chicago December 8, 2006.



Speaker, "Current trends in drafting pharmaceutical patent applications" for American Conference Institute's 7th Advanced Forum on Biotech Patents in Boston November 29-30, 2006.

Speaker, "Protecting You Pharmaceutical Inventions", State Intellectual Property Office of the People's Republic of China pharmaceutical conference in Beijing November 1-3, 2006.

Speaker and Course Organizer; Cambridge Healthtech Institutes's Second Annual Executives on Target pharmaceutical conference in Boston October 24-25, 2006. Short course on Protecting Your Pharmaceutical Inventions. Speaker on litigation issues involving pharmaceutical inventions.

Speaker, "Patents as Business Tools"; Cambridge Healthtech Institutes' Partnerships & Technology conference, August 17, 2006 in Boston.

Speaker, "Building Foundations for Screening Technologies, Therapeutics and Regenerative Medicine": Cambridge Healthtech Institutes' Science of Stem Cell Research conference, August 14, 2006 in Boston.

Speaker, "Patenting Peptides and Peptide-Related Inventions", CHI's Annual Peptide Conference, San Diego, January 2006 Speaker, "Overview of the Patent Application Process", Harvard University, 2003.

Speaker, "The Present Status of Gene Patenting", National Human Genome Research Institute, 2002.

Speaker, "Gene Patenting", University of Maryland School of Law, 2002 Speaker, "Patenting Plastics", Society of Plastic Engineers, 2001.

## Articles and Publications

"The Attack on Patentable Subject Matter Continues: Organic Seed v. Monsanto Pushes Utility to the Limit"; *BNA's Patent, Trademark & Copyright Journal*, May 2011

"The Attack on Patentable Subject Matter: ACLU v. Myriad Genetics as a Harbinger of Things to Come"; *BNA's Patent, Trademark & Copyright Journal*, August 2010

"Oral Argument Sheds Light in *Bilski v. Kappos*," *Genetic Engineering & Biotechnology News*, December 2009

"Tips on How to Properly Construe Patent Claims"; *Genetic Engineering & Biotechnology News*, December 2008

"Biotechnology & Pharmaceutical Sector Special Report"; *Financier Worldwide*, February 2007

"International Efforts Are Achieving Credible IP Enforcement Even Amid Chronic Abuse", *Intellectual Property & Technology Law Journal*, March 2006

"Stemming the Tide of Counterfeits Abroad", *National Law Journal*, December 2005

"Brazil's Agreement with Abbott: A New Perspective on Patent Prosecution as a Business Process", *Intellectual Property & Technology Law Journal*, December 2005

Zhongguancun Haidian Science Park Beijing, Beijing China, September 10, 2010



## SEAN J. JUNGELS

### *Attorney*

Sean Jungels enjoys practicing in all areas of intellectual property law. He has experience in researching and analyzing both legal and technical issues, drafting motions and opinions, and assisting in various phases of litigation and client counseling.

Sean currently concentrates on intellectual property litigation, representing clients from small companies to Fortune 500 corporations. Sean recently helped to represent a Fortune 500 client in the apparel industry in a trademark dispute.

Sean graduated Order of the Coif and earned his J.D. degree with high honors from Chicago-Kent College of Law. He also received a certificate in intellectual property law and two Cali awards in legal writing. He was also an associate editor for the Chicago-Kent Journal of Intellectual Property and was involved with the Intellectual Property Law Society. Sean earned a Bachelor of Science in Mechanical Engineering from the University of Illinois Urbana-Champaign.

Sean is admitted to practice before the Supreme Court of Illinois. He is also admitted to practice before the United States Patent and Trademark Office.

Sean Jungels practices in the Chicago, IL office of Banner & Witcoff, Ltd.



### **Office**

Ten South Wacker Drive  
Suite 3000  
Chicago, IL 60606-7407  
T 312.463-5000  
F 312.463.5001  
sjungels@bannerwitcoff.com

### **Education**

B.S., 2006, University of Illinois  
J.D., 2010, Chicago - Kent College of  
Law

### **Bar Admissions**

2010, Illinois

### **Practice Areas**

Counseling, Opinions & Licensing  
Litigation  
Patent Prosecution  
Trademarks

### **Industries**



## RAJIT KAPUR

Attorney

Rajit Kapur has handled a broad range of intellectual property issues in a number of different technical areas, including matters involving computer software, mobile devices, Internet applications, video games, graphical user interfaces, financial products and services, multimedia networks and systems, satellite communications and positioning systems, business methods, ergonomic office products, wind turbines, printers and multifunction devices, and mechanical devices. In addition to his extensive experience in drafting and prosecuting patent applications for different technologies, Rajit also has experience in researching and analyzing legal and technical issues, drafting opinions, preparing reexamination requests, and assisting in various phases of IP litigation and counseling.

Rajit's clients range from large corporations to small businesses, startups, and individual inventors. One of Rajit's representative clients is a software startup that designs and develops social networking apps, mobile games, and other innovative apps for mobile devices. In representing this company, Rajit has assisted in developing IP protection and enforcement strategies and in preparing and prosecuting a number of patent, trademark, and copyright applications.

While attending law school, Rajit first worked with the firm as a summer associate and as a law clerk, and he later spent several years with the firm as an attorney before relocating to Northern California. Prior to rejoining Banner & Witcoff in 2012, Rajit worked as an associate in the Silicon Valley office of a large international law firm, where his practice focused on patent prosecution in the electrical and computer arts.

Rajit earned his B.S. in Mechanical Engineering, *magna cum laude*, from Tufts University and his J.D. from The George Washington University Law School, where he was the Vice President of the Student Intellectual Property Law Association.



### Office

1100 13th Street, NW  
Suite 1200  
Washington, DC 20005-4051  
T 202.824.3000  
F 202.824.3001  
rkapur@bannerwitcoff.com

### Education

B.S. 2006, Tufts University  
J.D. 2009, George Washington  
University

### Bar Admissions

2009, California  
2011, District of Columbia

### Court Admissions

U.S. Patent and Trademark Office

### Practice Areas

Copyright  
Counseling, Opinions & Licensing  
Design Patents  
Litigation  
Patent Prosecution  
Trademarks

### Industries

Electrical & Computer Technologies  
Internet, E-Commerce & Business  
Methods



## ROBERT S. KATZ

### Attorney

Robert Katz has benefited firm clients in the areas of utility patents and industrial designs. Mr. Katz has drafted and prosecuted to issuance numerous and significant utility patents in the U.S. and in foreign countries. These clients include Fortune 500 companies as well as many individual inventors and small companies who rely on strong patent protection in their marketplaces. The patents have been directed primarily to mechanical and electromechanical devices, and to software and computer-related inventions. Many patents drafted and prosecuted by Mr. Katz have been successfully enforced with some having served as the cornerstone for the successful sale of companies.



Mr. Katz has also provided advice and prepared opinions regarding the patentability of inventions, patent infringement, patent validity, and trade secret protection to help clients properly assess the advantages and disadvantages of certain intellectual property and business decisions.

In patent and trademark litigation matters, he has assisted clients in enforcing and defending intellectual property related claims at the district court and the Court of Appeals for the Federal Circuit, and in the International Trade Commission.

Both nationally and internationally, Mr. Katz is considered as one of the premier practitioners in the field of industrial designs leading the way in the procurement and enforcement of design patents. On behalf of the firm's clients, he has helped procure over 5,000 design patents in the U.S. and over 15,000 design patents/registrations outside the U.S., and has helped to successfully enforce over 100 design patents. Leaders from foreign Design Patent Offices have consulted with him regarding industrial design policies, and he has been named as an expert in multiple design patent litigations.

He is a frequent speaker on industrial design-related topics and has been invited to speak before industry and legal professional organizations on six continents. He has spoken at conferences and seminars hosted by ABA (American Bar Association), AIPLA (American Intellectual Property Law Association), FICPI (Federation International des Conseils en Propriete Industrielle), INTA (International Trademark Association), IPO (Intellectual Property Owners Association), IPR University Center (Finland), the U.S. Patent and Trademark Office (USPTO), and WIPO (World Intellectual Property Office). Representatives from the Japanese Patent Office and WIPO have consulted with him on issues of design patent harmonization.

Mr. Katz has written articles addressing issues relating utility patent, design patent, and trade dress rights. Mr. Katz has authored a section of a recently published book entitled *Writing Patents for Litigation and Licensing* for BNA Publishing. He is currently a professor at George Washington University Law School teaching Design Law and a professor at Georgetown University Law School teaching Intellectual Property Pretrial Litigation Skills.

Mr. Katz is a member of several professional organizations including: AIPLA, FICPI, ABA, IPO, and IDSA (Industrial Design Society of America). In FICPI, he currently serves as Secretary of the U.S. Section, and is a former Chair of the Industrial Design Section for both FICPI and AIPLA. Mr. Katz also serves as a member of the Industrial Designs working group of the AIPLA Special Committee on Legislation, and on an INTA Presidential Task Force on Trademarks and Innovation.

Before joining Banner & Witcoff, Mr. Katz was a patent examiner at the USPTO. In that capacity, he examined patent applications for article and material handling devices covering a broad range of applications including robotics, conveyors, and loading and unloading vehicles. Mr. Katz also worked as a mechanical engineer at Digital Equipment Corporation's High Performance Systems where he designed mechanical, electrical, and electromechanical devices for main-frame computers. Additionally, he is a co-inventor of U.S. Patent No. 4,723,549 entitled "*Method and Apparatus for Dilating Blood Vessels*."

Mr. Katz earned his Bachelor of Science degree in Mechanical Engineering from Carnegie-Mellon University, and his Juris Doctor degree, with honors, from George Washington University. He is admitted to practice before many courts including the U.S. Court of Appeals for the Federal Circuit and the U.S. District Court for the Eastern District of Virginia. He is a member of the bar in Virginia and the District of Columbia, and is registered to practice before the U.S. Patent and Trademark Office.

Mr. Katz was named as one of the "Top 50 Under 45" intellectual property attorneys in 2008 by *IP Law*

### Office

1100 13th Street, NW  
Suite 1200  
Washington, DC 20005-4051  
T 202.824.3000  
F 202.824.3001  
rkatz@bannerwitcoff.com

### Education

B.S. 1986, Carnegie Mellon University  
J.D. 1992, George Washington University

### Bar Admissions

1992, Virginia  
1993, District of Columbia

### Court Admissions

U.S. Court of Appeals for the Federal Circuit  
U.S. District Court for the District of Columbia  
U.S. District Court for the Eastern District of Virginia  
U.S. Patent and Trademark Office

### Practice Areas

Design Patents  
Litigation  
Patent Prosecution  
Trademarks

### Industries

Internet, E-Commerce & Business Methods

*and Business.*

AV Peer Review Rated by the LexisNexis Martindale-Hubbell Ratings.

Mr. Katz practices in the Washington, DC office of Banner & Witcoff, Ltd.



## ANNA L. KING

### Attorney

Anna King enjoys practicing in many areas of intellectual property law. Anna currently concentrates her practice on trademark and copyright prosecution and counseling matters. Her experience in these fields includes prosecution of applications, enforcement and oppositions. She is part of a team representing a leading foodservice products company and a professional audio product company.

Anna co-wrote several articles for such organizations as The International Trademark Association, Practising Law Institute and The Bureau of National Affairs as well as World Trademark Review. A complete list of these articles can be seen below.

Anna currently serves as Chair of the Trademark Committee of the Intellectual Property Law Association of Chicago (IPLAC).

Anna was awarded her J.D. degree from Indiana University School of Law-Bloomington. There she was involved in the Intellectual Property Association, Sports & Entertainment Law Society and Sherman Minton Moot Court. Anna earned a Bachelor's of Arts degree in Anthropology, *cum laude*, from Connecticut College.

Anna is admitted to practice before the Supreme Court of Illinois and the U.S. District Court for the Northern District of Illinois.

Anna practices in the Chicago office of Banner & Witcoff, Ltd.

### Published Articles

- *Be prepared: The importance of due diligence in choosing between bench and jury trials*, (World Trademark Review) (April/May 2013).
- *Brand Locally, Think Globally: International Trademark Searching & Filing Strategies*, (Practicing Law Institute's Understanding Trademark Law) (June 2011).
- *Where to Start?: Understanding Trademark Searching and Filing in a Global Marketplace* (Practicing Law Institute's Understanding Trademark Law) (June 2010).
- *Caution: Do Not Outsource Your Ethical Obligations!, Outsourcing and Ethical Issues* (Int'l Trademark Ass'n Annual Meeting, Boston, MA) (May 2010).
- *Global Harmonization of Trademark Laws: Not Quite There Yet*, 74 BNA PTCJ 77 (2007).



### Office

Ten South Wacker Drive  
Suite 3000  
Chicago, IL 60606-7407  
T 312.463.5000  
F 312.463.5001  
aking@bannerwitcoff.com

### Education

B.A. 2002, Connecticut College  
J.D. 2006, Indiana University

### Bar Admissions

2008, Illinois

### Court Admissions

Supreme Court of Illinois  
U.S. District Court for the Northern  
District of Illinois

### Practice Areas

Copyright  
Trademarks

### Industries

DOWNLOAD BIO



## CRAIG W. KRONENTHAL

### Attorney

Craig Kronenthal devotes his practice to the preparation and prosecution of patent applications in various fields, and especially in the computer and electronic device areas. Additionally, Craig is actively involved in litigation and reexamination matters, client counseling, and preparing patentability and infringement opinions. Craig regularly works with start-ups and entrepreneurs as well as large, multinational corporations.

Craig has extensive experience in matters related to semiconductors, antennas, telecommunications, computer networks, data encryption, e-commerce, and nanotechnology. Craig also has significant experience in prosecuting and preparing applications for biomedical and mechanical inventions. Further, Craig has technical experience in the fabrication, measuring, and testing of micro-resonators and other silicon based microelectromechanical systems for biomedical applications.

Before joining Banner & Witcoff, Craig was a patent examiner at the U.S. Patent & Trademark Office (USPTO) for more than two years. As a patent examiner, his primary focus was on image processing with regards to watermark, biomedical, and object tracking applications. Moreover, Craig obtained valuable experience through his previous positions at the law firms of IP&T Group LLP in Annandale, VA, Sughrue Mion, PLLC in Washington, DC, and Christopher & Weisberg, PA in Ft. Lauderdale, FL. His experiences include conducting prior art searches, drafting patent applications, responding to office actions, and preparing trademark and patentability opinions.

Craig graduated from the Georgia Institute of Technology with a Bachelor of Science degree in Electrical Engineering and a Certificate of Entrepreneurship. While at Georgia Tech, Craig worked for the MicroSensors and MicroActuators Group in the School of Electrical and Computer Engineering. In addition, Craig earned his Juris Doctorate, *cum laude*, from the University of Miami School of Law. During law school, Craig participated in the Health and Elder Law Clinic and was Vice President of the Intellectual Property Law Society and a member of the University of Miami Business Law Review.

*Mr. Kronenthal is admitted to practice before the United States Patent & Trademark Office and in the State of Virginia. Practice in the District of Columbia is limited to matters and proceedings before federal courts and agencies.*



### Office

1100 13th Street, NW  
Suite 1200  
Washington, DC 20005-4051  
T 202.824.3000  
F 202.824.3001  
ckronenthal@bannerwitcoff.com

### Education

B.S. 2004, Georgia Institute of  
Technology  
J.D. 2009, University of Miami

### Bar Admissions

2009, Virginia

### Court Admissions

U.S. Patent and Trademark Office

### Practice Areas

Counseling, Opinions & Licensing  
Litigation  
Patent Post-Issuance Proceedings  
Patent Prosecution

### Industries

Electrical & Computer Technologies  
Internet, E-Commerce & Business  
Methods



## ERNEST V. LINEK

### Attorney

In over thirty years of practice, Ernest Linek has successfully prosecuted hundreds of U.S. and international patent applications in fields including natural product chemistry, polymer chemistry, pharmaceuticals, biotechnology, electroplating, semiconductors, and photoreceptors. Non-chemical utility patents and design patents obtained by Mr. Linek have included household storage containers, police safety equipment, toys, games and sporting goods.

In addition to his patent practice, Mr. Linek's trademark practice has resulted in his assisting clients in the selection and registration of hundreds of new trademarks and service marks, both in the United States and abroad, including Community Trademark and Madrid Protocol filings. He is also very active in providing client counseling and opinions regarding the validity and infringement of patents and trademarks.

Mr. Linek has extensive litigation experience and has successfully protected his client's interests in numerous Federal District Courts and before the U.S. Court of Appeals for the Federal Circuit. Specific areas of litigation have included trademark infringement, trade dress infringement, design patent infringement and utility patent infringement actions.

Mr. Linek also provides his clients with counseling and legal opinions regarding issues of validity and infringement of both patents and trademarks. On multiple occasions, Mr. Linek has served as a patent expert in litigation.

Mr. Linek also devotes time to the education of future lawyers, and he has been a guest lecturer at Franklin Pierce Law School in Concord, New Hampshire and at Northeastern Law School in Boston, Massachusetts.

Mr. Linek earned his B.S. degree in Chemistry (with a minor in computer science) in 1975 from the State University of New York, College at Fredonia, and his M.S. in Organic Chemistry in 1977 from the University of New Hampshire. He earned a J.D. degree in 1982 from Seton Hall University. From 1977 to 1984, Mr. Linek was employed by the multi-national pharmaceutical company - Merck & Co., first as a research chemist, then as a patent agent and finally as a patent attorney.

He is admitted to practice in the states of New Jersey and Massachusetts, as well as the Federal District Courts thereof. In addition, Mr. Linek is admitted in the U.S. District Court for the Eastern District of Wisconsin, and the Courts of Appeals for the Ninth and Federal Circuits. He is also active in numerous professional organizations, including the New York Academy of Science, the American Chemical Society, the American Bar Association, the Boston Bar Association, the Massachusetts Bar Association, the Federal Circuit Bar Association, the American Intellectual Property Law Association and the Boston Patent Law Association.

Mr. Linek was selected to appear on the 2007, 2008, 2009, 2010 and 2011 New England Super Lawyers list published by Thomson Reuters. The listings were published in *Boston Magazine* and in the legal publication, *New England Super Lawyers*.

AV Peer Review Rated by the LexisNexis Martindale-Hubbell Ratings.

Mr. Linek practices in the Boston office of Banner & Witcoff, Ltd.



### Office

28 State Street  
Suite 1800  
Boston, MA 02109-1705  
T 617.720.9600  
F 617.720.9601  
elinek@bannerwitcoff.com

### Education

B.S. 1975, State University of New York at Fredonia  
M.S. 1977, University of New Hampshire  
J.D. 1982, Seton Hall University

### Bar Admissions

1982, New Jersey  
1985, Massachusetts

### Court Admissions

U.S. Court of Appeals for the Federal Circuit  
U.S. Court of Appeals for the Ninth Circuit  
U.S. District Court for the District of Massachusetts  
U.S. District Court for the District of New Jersey  
U.S. District Court for the Eastern District of Wisconsin

### Practice Areas

Appellate Litigation  
Copyright  
Design Patents  
Jury Trials  
Litigation  
Patent Prosecution  
Trademarks

### Industries

Chemistry & Chemical Engineering  
Internet, E-Commerce & Business Methods  
Life Sciences & Pharmaceuticals  
Medical Devices





## ERIK S. MAURER

### Attorney

Erik Maurer focuses his practice on intellectual property litigation and counseling. He represents clients in matters involving utility patent, design patent, trade secret, trademark, trade dress, unfair competition, antitrust, and copyright issues, from both plaintiffs' and defendants' perspectives. In every instance, Erik strives to understand clients' goals and then to efficiently achieve those goals using appropriate advocacy and dispute resolution skills reinforced by modern technological resources.



With this approach Erik has successfully served as appellate advocate; handled temporary restraining order and preliminary injunction hearings; secured and executed seizure orders; examined witnesses, presented evidence, and argued to judge, jury, and arbitrator; efficiently conducted complex ESI discovery; drafted winning motions through every phase of litigation; and briefed successful appellate and amicus curiae submissions.

Mr. Maurer enjoys teaching and serves as an adjunct professor at Northwestern University School of Law in Chicago teaching Patent Trial Practice. Mr. Maurer taught Patent Trial Practice at the Georgetown University Law Center in DC, where he also taught Trial Practice in the High Technology Courtroom, a course he wrote based on experiences simplifying complex patent issues for expert examinations at trial and for pre-trial *Markman* hearings.

Mr. Maurer is also a contributing author to the *Patent Trial Advocacy Casebook, Second Edition* published by the American Bar Association.

Erik graduated *Order of the Coif* and earned his Juris Doctor, *cum laude*, from Northwestern University School of Law. He was an associate editor of *Northwestern's Law Review*, and published his article, "An Economic Justification for a Broad Interpretation of Patentable Subject Matter" in the *Law Review's* Spring 2001 volume. Prior to law school, Erik worked in the environmental engineering field and in policy development at the United States Environmental Protection Agency. Erik earned a Bachelors of Science in Biology from the University of Illinois, Urbana-Champaign in 1996.

Mr. Maurer has earned an AV Preeminent® peer review rating from Martindale-Hubbell. He was again named an "Illinois Super Lawyers Rising Star" in the field of Intellectual Property Litigation in the February 2011 edition of *Chicago Magazine*. Super Lawyers Rising Stars names the state's top 2% of up-and-coming attorneys under the age of 40 based on a comprehensive research process to find evidence of peer recognition and professional achievement.

Erik Maurer practices in the Chicago office of Banner & Witcoff, Ltd.

### Office

Ten South Wacker Drive  
Suite 3000  
Chicago, IL 60606-7407  
T 312.463.5000  
F 312.463.5001  
emaurer@bannerwitcoff.com

### Education

B.S. 1996, University of Illinois  
J.D. 2001, Northwestern University

### Bar Admissions

2001, Illinois

### Court Admissions

U.S. Supreme Court  
U.S. Circuit Court of Appeals for the Federal Circuit  
U.S. Court of Appeals for the Second Circuit  
U.S. Court of Appeals for the Seventh Circuit  
U.S. District Court for the Central District of Illinois  
U.S. District Court for the Northern District of Illinois  
U.S. District Court for the Western District of Wisconsin  
Supreme Court of Illinois  
U.S. Patent and Trademark Office

### Practice Areas

Appellate Litigation  
Design Patents  
Jury Trials  
Litigation  
Section 337/ITC Litigation  
Trade Dress  
Trademarks

### Industries

## CHRISTOPHER L. MCKEE

### Attorney

Christopher McKee has focused on patent litigation, counseling and prosecution throughout his career. His concentration is in the mechanical and electrical/computer related arts.

Mr. McKee has extensive experience in handling litigation-related patent reexaminations, as well as new post-grant proceedings available under the America Invents Act. Since enactment of the AIA, his practice has been largely devoted to handling of *inter partes* review (IPR) proceedings before the USPTO's Patent Trial and Appeal Board. He served as lead counsel on behalf of the patent owner in two of the earliest filed IPRs. One of those (IPR 2012-00041) was the first to conclude in denial of the IPR petition in its entirety. The other (IPR 2012-00042) was the first IPR to result in a final written decision upholding the bulk of the patent claims in the trial.

The AIA review proceedings and reexaminations he has handled have involved a variety of art areas, including electronic design automation (EDA), computer networking/digital data transmission and dynamic system control.

In addition, Mr. McKee has substantial experience in patent litigation and licensing matters, and he has prepared and successfully prosecuted scores of patent applications, in numerous technologies. These include EDA, integrated circuit fabrication, computer (hardware and software), telecommunications, medical device and machine tool technologies, and consumer appliances.

Mr. McKee began his career in intellectual property law with the USPTO, where he served as a patent examiner from 1984-86. There, he examined patent applications in a variety of arts, including metal founding and metal fusion bonding. Mr. McKee's early experience as a patent examiner has given him a particular sensitivity to examiner concerns, enabling him to negotiate cases to allowance with great effectiveness.

Mr. McKee serves as an adjunct law professor at the Georgetown University Law Center, teaching a class on Intellectual Property Litigation, Pretrial Skills. He previously served as a faculty member for Patent Resources Group's bi-annual patent bar review course, and as a steering committee member of the Bar Association of the District of Columbia's Patent, Trademark and Copyright Section. Mr. McKee chaired the firm's New Attorney Education program from 2003 - 2009, and remains active as a presenter in that program.

Mr. McKee earned his Bachelor of Science in Industrial Engineering from Iowa State University in 1983, and his Juris Doctor from the National Law Center of George Washington University in 1988. He is admitted to the bars of Virginia and the District of Columbia, and to practice before the Court of Appeals for the Federal Circuit and the Supreme Court of the United States.

Mr. McKee practices in the Washington, D.C. office of Banner & Witcoff, Ltd.



### Office

1100 13th Street, NW  
Suite 1200  
Washington, DC 20005-4051  
T 202.824.3000  
F 202.824.3001  
cmckee@bannerwitcoff.com

### Education

B.S. 1983, Iowa State University  
J.D. 1988, George Washington  
University

### Bar Admissions

1988, Virginia  
1991, District of Columbia

### Court Admissions

U.S. Court of Appeals for the Federal  
Circuit  
U.S. Supreme Court

### Practice Areas

Appellate Litigation  
Counseling, Opinions & Licensing  
Litigation  
Patent Interferences  
Patent Post-Issuance Proceedings  
Patent Prosecution  
Trade Dress

### Industries

Electrical & Computer Technologies  
Internet, E-Commerce & Business  
Methods



## HELEN HILL MINSKER

### Attorney

Helen Hill Minsker provides assistance to clients concerning a broad range of issues arising under trademark and unfair competition laws, as well as copyright law. Her experience in these fields of law includes counseling, prosecution and registration of applications before the U.S. Patent and Trademark Office and the U.S. Copyright Office, internet, licensing, enforcement, oppositions and cancellations, and litigation in the courts. Helen also counsels clients in protecting their trademark portfolios internationally.

Helen is active in a number of professional organizations. She has held leadership roles with national and international IP associations, including serving on both the INTA Board of Directors and the AIPLA Board of Directors (as a Board member and as Treasurer). From 2006 - 2009, Helen served on the Editorial Board of the INTA publication *The Trademark Reporter*. Over the years, Helen has chaired various committees for these associations and others, such as the ABA IP Law Section's Committee on Franchising, and she served as co-Chair of INTA's Annual Meeting in Amsterdam in 2003. Helen also was chair of the Bar Association of DC's Patent, Trademark & Copyright Law Section.

Helen received her undergraduate degree (A.B.) in political science from Vassar College, and her J.D. from George Washington University. She also spent a year studying at the London School of Economics and Political Science. She is admitted to the Bar of the District of Columbia Court of Appeals and the Bar of the Supreme Court of Illinois, as well as several courts, including the United States Supreme Court and the Court of Appeals for the Federal Circuit.

From 2001-2011, Helen served as an adjunct professor of law at Georgetown University, where she co-authored and taught a course on intellectual property pretrial litigation skills. She also is a frequent lecturer in continuing legal education programs, and is a former Contributing Editor/Trademarks for the *Federal Circuit Bar Journal*. On the international front, Helen is a member of the European Community Trademark Association (ECTA). Helen was included in "IP Stars - Top 250 Women in IP" in *Managing Intellectual Property* in 2013 and 2014, and recognized as a "World's Leading Trademark Professional" in the *World Trademark Review 1000* in 2012-2015.

Helen practices in the Chicago office of Banner & Witcoff, Ltd.



### Office

Ten South Wacker Drive  
Suite 3000  
Chicago, IL 60606-7407  
T 312.463.5000  
F 312.463.5001  
hminsker@bannerwitcoff.com

### Education

A.B. 1982, Vassar College  
J.D. 1987, George Washington  
University

### Bar Admissions

1988, District of Columbia  
2007, Illinois

### Court Admissions

U.S. Supreme Court  
U.S. Circuit Court of Appeals for the  
Federal Circuit  
U.S. Court of Appeals for the Seventh  
Circuit  
U.S. District Court for the Central  
District of Illinois  
U.S. District Court for the District of  
Columbia  
U.S. District Court for the Northern  
District of Illinois

### Practice Areas

Appellate Litigation  
Copyright  
Counterfeit Goods Seizure  
Litigation  
Trade Dress  
Trademarks

### Industries

Internet, E-Commerce & Business  
Methods



## ASEET PATEL

### Attorney

Aseet Patel concentrates on patent prosecution and litigation matters primarily in the electrical, computer, and business method arts. He also provides opinion counseling services to clients, including various types of clearance opinions on patents.

Mr. Patel relies on his experience as a former Patent Examiner at the United States Patent and Trademark Office when representing clients in all phases of the prosecution of patent applications. While at the Patent Office, Mr. Patel examined patent applications directed to high technology inventions such as memory devices, RAMs/ROMs, flash memories, caching algorithms, memory partitioning techniques, memory addressing techniques, hard drives, and RAID systems.

Before serving at the Patent Office, Mr. Patel worked as a consultant and programmer for Trilogy Software, Inc. in Austin, TX where he helped develop and deploy multi-million dollar software products for Fortune 500 clients. He is Java Programmer Certified by Sun Microsystems and has developed e-commerce software using HTML, Java server pages (JSP), Java, javascript, relational database technologies, and other web technologies.

At Banner & Witcoff, Mr. Patel has been preparing and prosecuting patent applications for many years in a variety of technology areas, including those relating to electronic circuits, computer hardware and networks, cellular telephones, Internet and e-commerce, business methods, semiconductor processing, and medical devices.

Mr. Patel also has substantial litigation experience. He has represented clients in all aspects of litigation, including pre-trial discovery, witness preparation, depositions, and trial. While representing a major set-top box manufacturer in a multi-patent infringement suit, Mr. Patel used his software expertise to analyze source code in several different programming languages to assess infringement and assisted at the depositions of technology-savvy witnesses. Mr. Patel has also prepared witnesses and exhibits for trial and drafted various court documents.

Mr. Patel earned a B.S. degree in Computer Engineering from the University of Illinois at Urbana-Champaign, where he was the Vice President of the Institute of Electrical and Electronic Engineers (IEEE) student chapter, a Student Senator representing the College of Electrical and Computer Engineering, and the recipient of numerous scholarships. Mr. Patel received his Juris Doctor degree from Loyola University Chicago School of Law. He is admitted to the bar of the State of Illinois and is registered to practice before the United States Patent and Trademark Office.

Mr. Patel was recently recognized in *Lawyers of Color's* "Hot List 2013," an inaugural publication that honors early- to mid-career attorneys from six different regions in the U.S. who have excelled in the legal profession.

Mr. Patel practices in the Chicago office of Banner & Witcoff, Ltd.

[Download the Invention Disclosure Meeting Checklist](#)



### Office

Ten South Wacker Drive  
Suite 3000  
Chicago, IL 60606-7407  
T 312.463.5000  
F 312.463.5001  
apatel@bannerwitcoff.com

### Education

B.S. 2000, University of Illinois  
J.D. 2005, Loyola University

### Bar Admissions

2006, Illinois

### Court Admissions

U.S. Patent and Trademark Office  
U.S. Circuit Court of Appeals for the  
Federal Circuit

### Practice Areas

Litigation  
Patent Prosecution

### Industries

Electrical & Computer Technologies  
Internet, E-Commerce & Business  
Methods



## H. WAYNE PORTER

### Attorney

Wayne Porter concentrates his practice in patent prosecution and related counseling, including evaluation of patent infringement and validity issues. He has prepared and prosecuted numerous patent applications in various software, electronic and mechanical fields. His areas of experience include database management, electronic design automation, microprocessor emulation, signal processing, computer input devices and other computer hardware, user interfaces, power conversion and regulation, telecommunications, computer networking, electrical connectors, construction materials, medical devices, manufacturing, and semiconductors. He has substantial experience in design patents, and has also assisted clients in other areas of intellectual property law, including copyrights.

Prior to receiving his law degree, Mr. Porter was employed as a mechanical engineer for the United States Government, where his duties included mechanical design and testing.

Mr. Porter earned a Bachelor of Mechanical Engineering from the Georgia Institute of Technology and a Juris Doctor degree, with *high honors*, from the University of Florida College of Law. While in law school, he was on the board of the *Florida Law Review* and graduated as a member of the Order of the Coif. Mr. Porter is admitted to practice before the U.S. Patent and Trademark Office and in the District of Columbia. Mr. Porter is also a member of the Florida bar and of the American Bar Association.

Mr. Porter practices in the Washington, DC office of Banner & Witcoff, Ltd.



### Office

1100 13th Street, NW  
Suite 1200  
Washington, DC 20005-4051  
T 202.824.3000  
F 202.824.3001  
wporter@bannerwitcoff.com

### Education

B.S.M.E. 1984, Georgia Institute of  
Technology  
J.D. 1990, University of Florida

### Bar Admissions

1990, Florida  
2002, District of Columbia

### Court Admissions

U.S. Patent and Trademark Office  
U.S. Supreme Court

### Memberships

American Bar Association (ABA)

### Practice Areas

Counseling, Opinions & Licensing  
Design Patents  
Patent Post-Issuance Proceedings  
Patent Prosecution

### Industries

Electrical & Computer Technologies  
Internet, E-Commerce & Business  
Methods



## CHRISTOPHER J. RENK

### Attorney

Chris Renk focuses his practice on litigating patent, trademark, copyright, trade secret, false advertising and unfair competition cases. Chris utilizes a value added approach in his litigation practice and believes that litigation goals should always be defined by each client's business objectives. He is skilled in developing and implementing litigation strategies to fulfill those objectives.

Since joining the firm in 1988, Chris has successfully represented both plaintiffs and defendants as lead and co-counsel in jury trials, bench trials, and appeals. His cases have involved diverse subjects such as computer software, consumer electronics, product designs, electrical controls, internet content delivery, medical and surgical devices, heat transfer, distilled spirits, contact lenses, fuel injection systems, athletic footwear and textiles processing.

In each year from 2010 to 2014, Chris was selected for inclusion in the editions of *The Best Lawyers in America* (click link to view). *Best Lawyers* is considered the oldest and most respected national peer-review publication in the legal profession, and is based on an annual peer-review survey. In each year from 2005 to 2014, Chris was included in *Illinois Super Lawyers*, and was also selected to their Top 100 list featured in *Chicago* magazine in 2005, 2009, 2010 and 2011. Since 2004, Chris has yearly been named to the *Leading Lawyers Network* and in 2010 was profiled in *Leading Lawyers* magazine (click link to view). Based upon peer nominations and approval by the network's Advisory Board, only the top lawyers are nominated and eligible for membership in the *Leading Lawyers Network*. In 2014, Chris was named on the BTI Client Service All-Star Report. Inclusion in this exclusive report is driven solely by direct feedback from in-depth interviews of General Counsels from more than 3,700 large and Fortune 1000 companies. These interviews determine precisely which attorneys top the charts in client service excellence. Law firms and their attorneys have no influence on these rankings.

In addition to his active practice, Chris is a fellow of the American Bar Foundation and is a Member of the Sedona Conference Working Group on Patent Remedies. Chris also serves as an Adjunct Professor of Law at the Georgetown University Law Center and Northwestern University Law School where he teaches Patent Trial Practice and Patent Litigation II. He is a contributing author of the *Patent Litigation Strategies Handbook*, BNA, 2000, *Patent Litigation*, PLI, 2001, and *Patent Trial Advocacy Casebook*, (Third Edition), ABA, 2013. Chris is a frequent speaker on various intellectual property issues, is the author of several articles on intellectual property law, and has been a featured guest on WB's First Business (click link to view), discussing intellectual property piracy in China.

Chris earned his engineering degree from Iowa State University in 1983. Prior to attending law school, he was an engineer at General Dynamics Corporation. He is a 1988 graduate of the University of Minnesota Law School.

Chris is a registered patent attorney and is admitted to practice in Illinois, Minnesota, and the District of Columbia. He also is admitted to practice before the United States Supreme Court, the Court of the Appeals for the Federal Circuit and numerous federal district courts.

Mr. Renk practices in the Chicago office of Banner & Witcoff, Ltd.



### Office

Ten South Wacker Drive  
Suite 3000  
Chicago, IL 60606-7407  
T 312.463.5000  
F 312.463.5001  
crenk@bannerwitcoff.com

### Education

B.S. 1983, Iowa State University  
J.D. 1988, University of Minnesota

### Bar Admissions

1988, Illinois  
1990, Minnesota  
1991, District of Columbia

### Court Admissions

U.S. Supreme Court  
U.S. Circuit Court of Appeals for the Federal Circuit  
U.S. Court of Appeals for the Fourth Circuit  
U.S. Court of Appeals for the Fifth Circuit  
U.S. Court of Appeals for the Sixth Circuit  
U.S. Court of Appeals for the Seventh Circuit  
U.S. District Court for the Central District of Illinois  
U.S. District Court for the Northern District of Illinois  
U.S. District Court for the Western District of Michigan  
U.S. District Court for the Eastern District of Wisconsin  
Supreme Court of Illinois  
Supreme Court of Minnesota  
District of Columbia Court of Appeals  
U.S. Patent and Trademark Office

### Practice Areas

Appellate Litigation  
Copyright  
Design Patents  
Jury Trials  
Litigation  
Section 337/ITC Litigation  
Trade Dress  
Trademarks

### Industries

Electrical & Computer Technologies  
Internet, E-Commerce & Business  
Methods  
Medical Devices



## PAUL M. RIVARD

### Attorney

Paul M. Rivard has extensive experience in counseling in intellectual property matters and in preparing and prosecuting patent applications in the chemical and pharmaceutical arts. His practice focuses on developing and managing worldwide patent portfolios with a view toward meeting his clients' business objectives. Representative technologies include plastics and polymer chemistry, molding and coating technologies, chemical manufacturing, packaging materials, pharmaceuticals, ceramics, composite materials, and agricultural sciences.

Paul handles all phases of patent practice before the U.S. Patent and Trademark Office, including ex parte prosecution, reissue applications, reexamination proceedings, as well as ex parte appeals and contested matters before the Patent Trial and Appeal Board. Recently he successfully defended a patent owner in ex parte reexaminations that had been requested by a patent infringement-defendant. The reexamination decisions were favorably cited by the U.S. Court of Appeals for the Federal Circuit when it reversed a jury verdict of invalidity in the concurrent litigation.

Mr. Rivard also is experienced in preparing technology transfer agreements and has represented clients in intellectual property litigation before the U.S. District Courts and the U.S. Court of Appeals for the Federal Circuit.

Paul is active in the American Bar Association, having authored amicus curiae briefs for the ABA in patent cases before the U.S. Supreme Court, including *KSR v. Teleflex*. Prior to entering private practice, he served as a Patent Examiner in the U.S. Patent and Trademark Office, where he examined applications in the chemical arts.

Paul earned a Juris Doctor, cum laude, from Catholic University in Washington, DC, and a Bachelor of Science in chemical engineering from Clarkson University in Potsdam, New York.

Mr. Rivard practices in the Washington, DC office of Banner & Witcoff, Ltd.



### Office

1100 13th Street, NW  
Suite 1200  
Washington, DC 20005-4051  
T (202) 824-3000  
F (202) 824-3001  
privard@bannerwitcoff.com

### Education

B.S. 1992, Clarkson University  
J.D. 1998, Catholic University

### Bar Admissions

1998, Virginia  
1999, District of Columbia

### Court Admissions

U.S. Court of Appeals for the Federal Circuit  
U.S. Court of Appeals for the Fourth Circuit  
U.S. District Court for the Eastern District of Virginia  
U.S. Supreme Court  
U.S. Patent and Trademark Office

### Practice Areas

Counseling, Opinions & Licensing  
Patent Interferences  
Patent Prosecution

### Industries

Chemistry & Chemical Engineering  
Life Sciences & Pharmaceuticals



## CHARLES W. SHIFLEY

Attorney

Over a full career, Charles Shifley has concentrated on intellectual property cases and trials. Recently, Charles and a team gained the transfer of an ongoing patent case from the home base of Caterpillar in Peoria to a neutral court in Las Vegas. See 2012 WL 6618602. Earlier counsel had failed in a motion to dismiss from Peoria. Charles and a team also kept the ongoing defense of a motorcycle manufacturer away from risks of a jury by diverting the patent dispute into arbitration. Charles has been succeeding for patent owners in patent post-grant proceedings, putting requesters in situations worse for them than if they had not started proceedings they expected to win for them. See USPTO 95/001600, 95/000437, 95/000467. Charles enjoys juries, avoiding juries, fast-paced efforts, and resolutions that involve allowing others to act and events to occur in their own time. Last year, Charles and a team brought to a settlement a multi-year defense of a large automotive company against patent infringement for duplicating the products of a terminated supplier in 2008. Injunction efforts were defeated and the settlement was less than 6% of the supplier's demand, at one-third the supplier's legal fees. Earlier, Charles avoided litigation altogether by engaging opponents as needed and appropriate, while having third parties have priority and defeat the opponents, and even simply watching as windows of liability closed from passages of time.

In contrast, Charles is skilled in gaining fast relief for clients in difficult situations. Charles and a team brought the urgent enforcement of a patent for a construction industry company to a successful result in eight months, on a patent Charles had gained for the company. See Civil Action No. 4:07-cv-2099 (E.D.Mo.) Charles and teams of lawyers have gained preliminary injunctions on a once-lapsed patent, see 56 USPQ2d 1329, a just-issued patent, see 53 USPQ2d 1547, and a patent in an uncertain market, see 2006 U.S. Dist. LEXIS 4910. Earlier, Charles directed a team of lawyers for an arbitration in the digital video disk and movie industries, within 16 days of notice of arbitration. The arbitration settled on the 16th day, in major part because of the speed and thoroughness of the preparation. Charles also gained two trademark preliminary injunctions, see 48 USPQ2d 1299 and 45 USPQ2d 1846. Similarly, Charles and a team brought the defense of a major instant message provider against a \$160M patent claim to a successful early summary judgment and resulting settlement. See Civil Action 04C4240 (N.D.I.). Charles and a trial team successfully enforced IP rights for a start up company against a multimillion-dollar defense effort. Charles also successfully defended an Internet music delivery company, successfully defended a rail supply company, and successfully ended an offensive case for a pharmaceutical software provider. Charles has gained several other early injunctions and seized counterfeit goods within hours of filing suits and within a day of contact with clients having problems to solve. In a case including a jury trial, Charles and his trial team proved willful patent infringement and had a permanent injunction in place 11 months after filing suit.

Where extended efforts are required, Charles provides them. Charles and a team brought the defense of the automotive industry and the nation's largest automotive supplier to a successful, affirmed summary judgment against patent infringement. See 501 F.3d 1274. Earlier, a trial team under his direction won an affirmed \$6M jury verdict for willful patent and copyright infringement and breach of a shrink-wrap agreement. See 302 F.3d 1334. Charles also won an affirmed multi-million dollar jury award for willful patent infringement and attorneys fees. See 9 F.Supp.2d 601, 1999 U.S. App. LEXIS 8584, and 189 F.3d 1327. Charles and a team brought the defense of a major building systems provider against a \$200M trade secret misappropriation claim through extended arbitration discovery and to a successful settlement. See Civil Action 3:07CV312 (N.D.Tex.). Charles was also co-counsel in a trial defeating patent infringement claims, see 65 F.Supp.2d 757, and defended the judgment on appeal, 56 USPQ2d 1445. Earlier, and at a jury trial, Charles and a team of lawyers won an affirmed permanent injunction and \$1M patent infringement award. See 61 USPQ2d 1152. Charles has also gained an important 7th Circuit trademark decision by appeal, see 362 F3d 986.

Charles has served as lead and co-counsel in numerous successful trials and appeals for Fortune 100 and additional companies, across the country. Technical subjects have included in-building wireless systems; airbag actuation electronics; Internet delivery software; digital video disks; photochemistry; photographic software; engines, electronic components, and automotive hardware; human heart pacemakers and defibrillators; welding equipment; computerized controls; high technology valves; industrial franchise operations; high-technology metal casting and consumer goods. He has generated several large claims for damages, including one for \$30 million based on \$300,000 in accused sales. He has been consistently sensitive to costs and client communication.



### Office

Ten South Wacker Drive  
Suite 3000  
Chicago, IL 60606-7407  
T 312.463.5000  
F 312.463.5001  
cshifley@bannerwitcoff.com

### Education

B.S.M.E. 1973, Ohio State University  
J.D. 1976, Ohio State University

### Bar Admissions

1976, Illinois

### Court Admissions

Supreme Court of Illinois  
U.S. Court of Appeals for the Federal Circuit  
U.S. Court of Appeals for the Seventh Circuit  
U.S. District Court for the Eastern District of Michigan  
U.S. District Court for the Eastern District of Wisconsin  
U.S. District Court for the Northern District of Illinois  
U.S. District Court for the Central District of Illinois

### Practice Areas

Appellate Litigation  
Copyright  
Counseling, Opinions & Licensing  
Jury Trials  
Litigation  
Patent Interferences  
Patent Post-Issuance Proceedings  
Trademarks

### Industries

Electrical & Computer Technologies  
Internet, E-Commerce & Business  
Methods  
Life Sciences & Pharmaceuticals  
Medical Devices



In addition, Charles has also developed capable counseling, negotiation, settlement and patent procurement strategy skills, see USPTO 13/116851, and prepared opinions and gained clients many valuable contracts concerning patents, trademarks, copyrights, trade secrets, and franchises. He is proud to have had a client grow from startup to \$25M in sales in a short time on the strength of its inventions, patents he gained, and patent enforcement suits he successfully pursued. He is also proud to have brought an individual inventor patent license royalties in excess of \$1M, for a single and simpler invention.

Mr. Shifley speaks on patent litigation and related matters, and authors articles espousing critical thinking in handling intellectual property concerns. He has taught pretrial, trial and appellate advocacy at Northwestern University, Georgetown, John Marshall of Chicago, and Chicago Kent Colleges of Law, with Federal Circuit Court of Appeals Chief Judge Paul Michel among others, and taught Law for Engineering Managers at Northwestern for many years. He is currently an Adjunct Professor at John Marshall Law School, Chair of the Amicus Committee of the Intellectual Property Law Association of Chicago, and past President of the Richard Linn American Inn of Court. Charles has represented IPLAC in several U.S. Supreme Court, Federal Circuit and Illinois Supreme Court cases on issues including patent-eligible subject matter, patent damages, jurisdiction, and inequitable conduct. See Supreme Court 11-1118, Federal Circuit 2011-1301, 2011-1363, 2012-1548 and Illinois 112910.

Charles earned a Bachelor of Science degree in Mechanical Engineering, summa cum laude, and a Juris Doctor degree, cum laude, both from The Ohio State University, in his home state.

Mr. Shifley practices in the Chicago office of Banner & Witcoff, Ltd.

## JOSEPH M. SKERPON

Attorney

Joseph Skerpon practices in the areas of litigation, interferences, counseling in patent matters, licensing and the preparation and prosecution of patent applications in the chemical and biotechnology arts. Throughout his career, Mr. Skerpon has achieved each client's business objectives by maintaining a close working relationship. This has been particularly evident in his successful resolution of numerous interferences, whether by settlement, on preliminary motion, or through testimony to Final Hearing.

He also has experience in civil litigation following interference proceedings, having protected favorable Patent Office decisions through the district court and the Federal Circuit. In this regard, he helped to define the bounds of raising new issues in an interference appeal when he successfully argued before the Federal Circuit in the case of *G.I. v. Scientific Atlanta*. Mr. Skerpon's patent litigation experience includes both bench and jury trials.

Mr. Skerpon also has a broad patent preparation and prosecution practice with experience in wood and paper technologies, polymers and other organic and inorganic materials, pharmaceuticals, food technology and general chemical processing.

Mr. Skerpon received his B.S. in Chemical Engineering, *cum laude*, from Princeton University in 1975 and his J.D., with *honors*, from the University of Buffalo in 1981. Employed for seven years as a patent liaison, senior chemical engineer for the Linde Division of the Union Carbide Corporation before entering private practice in 1982, he earned invaluable experience working directly with inventors in helping to define their inventive contributions.

Mr. Skerpon is a member of the American Intellectual Property Law Association, the Bar Association of the District of Columbia, the American Bar Association, and is an Adjunct Professor of Law at George Mason University and Johns Hopkins University, teaching in the areas of patent law and biotechnology patent law. Mr. Skerpon is admitted to the bar in New York and the District of Columbia and before the U.S. Court of Appeals for the Federal Circuit and the U.S. District Court of the District of Columbia.

Mr. Skerpon practices in the Washington, DC office of Banner & Witcoff, Ltd.



### Office

1100 13th Street, NW  
Suite 1200  
Washington, DC 20005-4051  
T 202.824.3000  
F 202.824.3001  
jskerpon@bannerwitcoff.com

### Education

B.S.Ch.E. 1975, Princeton University  
J.D. 1981, University of Buffalo

### Bar Admissions

1982, New York  
1983, District of Columbia

### Court Admissions

U.S. Court of Appeals for the Federal  
Circuit  
U.S. District Court for the District of  
Columbia

### Practice Areas

Litigation  
Patent Interferences  
Patent Prosecution

### Industries

Chemistry & Chemical Engineering  
Life Sciences & Pharmaceuticals

## RICHARD S. STOCKTON

### Attorney

Richard Stockton has substantial experience with intellectual property counseling, litigation and prosecution matters.

He provides tactical and strategic advice to clients based on a broad range of experience stemming from large and small patent, copyright and trademark litigations, preparation of opinions, prosecution work, general counseling and the management of portfolios, including a portfolio with more than 2000 properties.

With regard to prosecution, he has obtained more than 1000 US design patents, trademark registrations, copyright registrations and utility patents for clients. Richard writes and presents on various intellectual property topics, from basic trademark and America Invents Act overviews to detailed assessments of ICANN's generic top level domain liberalization and the Hague System for international design registration.

Internationally, Richard manages thousands of intellectual properties in more than 70 foreign jurisdictions, has experience with mass multi-jurisdictional transfers of properties between entities, and has visited more than 70 countries.

Richard earned a Bachelor of Science degree in Electrical Engineering from the University of Illinois at Urbana-Champaign in 1997, where he was a member of the Mortar Board, Eta Kappa Nu, Knights of St. Patrick and Senior 100 honor societies.

Richard graduated, *cum laude*, from the University of Illinois College of Law in 2000, where he was the Editor-in-Chief of *The University of Illinois Journal of Law, Technology & Policy* and the Legislation Editor of the Illinois Law Update section of *The Illinois Bar Journal*. He participated in the Giles S. Rich Intellectual Property Moot Court competition, was a founding editor of *Modern Trends in Intellectual Property* and received a Rickerts award.

Richard continues his involvement with the University of Illinois as a member of the Athletic Board and as a member of the President's Council, Chancellor's Circle and Cribbet Society. He also served on the Board of Visitors for the College of Law, Board of Directors of the University of Illinois Law Alumni group, and was a member of the Campus Alumni Advisory Board. He has also volunteered for the Division of Intercollegiate Athletics and the Illinois Imprint leadership program, has mentored dozens of students, and regularly returns to campus to discuss careers in patent law.

In 2012, Northwestern University School of Law appointed Richard as an Adjunct Professor, where he co-teaches "Intellectual Property Pre-Trial Litigation Skills." Richard taught the same course as an Adjunct Professor at Georgetown University Law Center from 2005-2011. He also serves on the Midwest Coordinating Committee for the INTA-sponsored Saul Lefkowitz Trademark Moot Court Competition, and has been a panelist, moderator or speaker at the University of Illinois College of Law, Northwestern University School of Law, Chicago-Kent College of Law and The John Marshall Law School. Richard is also a co-chair of the Technology for the Litigator committee of the American Bar Association's Section of Litigation.

Richard also has experience with governmental relations. He has drafted legislation for members of the Illinois General Assembly, including P.A. 91-778, which substantially amended the University of Illinois Board of Trustees Act. Richard also interned for a Congressman in Washington D.C. and served as a legislative extern to the Illinois House of Representatives.

Richard has been named an "Illinois Super Lawyers Rising Star," which touts the state's top 2% of up-and-coming attorneys under the age of 40.

Richard is admitted to the Illinois State Bar and is also admitted to practice in the U.S. Patent and Trademark Office as a registered patent attorney. He is a member of the American Bar Association, Illinois State Bar Association, International Trademark Association and the American Intellectual Property Law Association.

Richard practices in the Chicago office of Banner & Witcoff, Ltd.



### Office

Ten South Wacker Drive  
Suite 3000  
Chicago, IL 60606-7407  
T 312.463.5000  
F 312.463.5001  
rstockton@bannerwitcoff.com

### Education

B.S. 1997, University of Illinois  
J.D. 2000, University of Illinois

### Bar Admissions

2000, Illinois

### Court Admissions

U.S. District Court for the Northern  
District of Illinois  
U.S. Patent and Trademark Office

### Practice Areas

Copyright  
Counterfeit Goods Seizure  
Design Patents  
Litigation  
Trade Dress  
Trademarks

### Industries

Electrical & Computer Technologies  
Internet, E-Commerce & Business  
Methods



## J. PIETER VAN ES

### Attorney

Pieter van Es has over twenty years of experience in intellectual property enforcement, counseling and procurement. He has worked on matters involving patent, trademark, trade dress, copyright, trade secret and antitrust issues.

Pieter has handled intellectual property disputes in trials and preliminary injunction hearings, conducted complex discovery and briefed successful motions and appeals. His experience has ranged from ex parte seizures of counterfeit goods to advantageous settlement of disputes in court supervised settlement hearings. He has procured and licensed patents and trademarks for clients in a wide variety of fields. The subject matter of his work has included electronic sensors and monitors, medical and diagnostic devices, audio electronics, telecommunications equipment, lighting fixtures, internet content delivery networks, processed food, healthcare products, sporting goods and software.

Pieter has been selected as an "Illinois Super Lawyer" nearly every year since 2005. The Super Lawyers list represents the top 5% of Illinois lawyers, as chosen through a peer balloting process involving 47,000 lawyers from across Illinois, and through a research and review panel organized by *Law & Politics* magazine. *Law & Politics* asked the attorneys to name the best lawyers they personally observed in action.

Pieter recently taught intellectual property litigation as an adjunct professor of law at Northwestern Law School in Chicago and the Georgetown University Law Center in Washington, D.C. He earned a Bachelor of Science degree in Electrical Engineering and a Bachelor of Arts degree in Economics both from the University of Illinois at Urbana-Champaign in 1989. He graduated, *magna cum laude*, from the University of Illinois College of Law in 1992.

Pieter is a registered patent attorney and is admitted to practice in the states of Illinois and California. He also is admitted to practice before the Court of the Appeals for the Federal Circuit, numerous other federal courts and the Illinois Supreme Court. He practices out of the Chicago office of Banner & Witcoff, Ltd.



### Office

Ten South Wacker Drive  
Suite 3000  
Chicago, IL 60606-7407  
T 312.463.5000  
F 312.463.5001  
pvanes@bannerwitcoff.com

### Education

B.S. 1989, University of Illinois  
B.A. 1989, University of Illinois  
J.D. 1992, University of Illinois

### Bar Admissions

1992, Illinois  
2007, California

### Court Admissions

Supreme Court of Illinois  
U.S. Court of Appeals for the Federal Circuit  
U.S. Court of Appeals for the Fifth Circuit  
U.S. Court of Appeals for the Ninth Circuit  
U.S. Court of Appeals for the Seventh Circuit  
U.S. District Court for the Northern District of Illinois

### Practice Areas

Jury Trials  
Litigation  
Patent Post-Issuance Proceedings  
Section 337/ITC Litigation  
Trademarks

### Industries

Electrical & Computer Technologies  
Internet, E-Commerce & Business Methods



## BRADLEY J. VAN PELT

### Attorney

Brad Van Pelt concentrates on litigation, prosecution, and counseling in all areas of intellectual property. Brad has wide-ranging experience in prosecution and counseling. He has years of patent drafting experience in the mechanical, software, and business method arts. He frequently prepares freedom-to-practice opinions, and has served on successful patent litigation teams in obtaining favorable rulings for clients. In addition to his utility patent practice, Brad also has extensive experience in procuring design patents and is active in the design patent bar. He was also named to the 2014 Illinois Super Lawyers Rising Stars, which include only the top 5 percent of attorneys in the state.



Brad assists clients with creative strategies in developing strong patent portfolios both domestically and internationally. Brad leverages his experience as a former examiner to creatively advance applications to grant. He has also presented at numerous conferences on creative strategies in advancing applications and development of prosecution strategies in light of the America Invents Act.

Brad has prepared and prosecuted software-oriented applications directed to security, networking, audio monitoring, cash handling devices, business methods, and graphical user interfaces and mechanical applications directed to merchandizing systems, transducers, microphones, earbuds, medical devices, insulation devices, sporting equipment, composite materials, container handlers, and dispensers.

Prior to his role at Banner & Witcoff, Brad was a patent examiner at the U.S. Patent and Trademark Office in the early 2000s. While at the Patent and Trademark Office, Brad examined patent applications directed to the mechanical arts, especially in the automotive, transportation, and power generation arts. Brad served in the chambers of the Honorable Richard Linn of the United States Court of Appeals for the Federal Circuit, which hears all patent appeals in the United States. Brad was also a design engineer for Sub-Zero Freezer Company where he designed testing equipment for digital refrigeration components and software.

He earned his undergraduate degree in Mechanical Engineering from the University of Wisconsin-Madison in 2002. He was awarded his J.D. degree from Georgetown University in 2007.

Brad is registered to practice before the U.S. Patent and Trademark Office, and is admitted to practice in Illinois. Brad practices in the Chicago office of Banner & Witcoff, Ltd.

### Presentations

- "The Total User Experience: Improving the Content and Quality of Your Company's Patent Application Post-AIA" at Witcon, Banner & Witcoff's Corporate Intellectual Property Seminar in 2014
- "The Total User Experience: Improving the Content and Quality of Your Company's Patent Application Process Post-AIA" at the MIP conference in DC in 2014
- "Two Sides of Patents: Getting Stronger Patents for Your Company and Alternative Ways to Defend Against Patent Litigation." At the ACC Chicago CLE Program in Rosemont, IL and in Chicago, IL in 2014
- "The Total User Experience: Improving the Content and Quality of Your Company's Patent Application Process Post-AIA" in a Banner & Witcoff and BNA webinar in 2013
- "Emergency IP: Expediting the Granting of Patent Rights" at Banner & Witcoff's Corporate Intellectual Property Seminar in 2012

### Articles

"AIA Toolbox: Intake, Checklists, and Faster Drafting Techniques," IP Update, Fall/Winter 2014

### Office

Ten South Wacker Drive  
Suite 3000  
Chicago, IL 60606-7407  
T 312.463.5000  
F 312.463.5001  
bvanpelt@bannerwitcoff.com

### Education

B.S. 2002, University of Wisconsin  
J.D. 2007, Georgetown University

### Bar Admissions

2007, Illinois

### Court Admissions

U.S. Patent and Trademark Office

### Practice Areas

Copyright  
Counseling, Opinions & Licensing  
Litigation  
Patent Prosecution  
Trademarks

### Industries



## WILLIAM E. WOOTEN

### Attorney

William Wooten maintains a comprehensive intellectual property practice, with an emphasis on prosecution, litigation, and counseling in patent matters. He has prepared and prosecuted numerous patent applications directed to a wide range of technologies, including computer software and hardware, near field communication, medical imaging, telecommunications, and business methods. Mr. Wooten works with a diverse base of clients, including members of the Fortune 500, startups, universities, and individual inventors.

Mr. Wooten earned his B.S. in Computer Science, *summa cum laude*, at North Carolina State University and his J.D. with honors at the University of North Carolina School of Law, where he was a staff member of the *North Carolina Law Review* and the *North Carolina Journal of Law & Technology*. Prior to attending law school, Mr. Wooten served as an officer in the United States Navy and worked in information technology for an aerospace wire manufacturer. Mr. Wooten is admitted to the State Bar of North Carolina and is registered to practice before the United States Patent & Trademark Office.

Mr. Wooten practices in the Washington, DC office of Banner & Witcoff, Ltd.



### Office

1100 13th Street, NW  
Suite 1200  
Washington, DC 20005-4051  
T 202.824.3000  
F 202.824.3001  
wwooten@bannerwitcoff.com

### Education

J.D. 2010, University of North Carolina  
B.S. 2004, North Carolina State  
University

### Bar Admissions

2010, North Carolina  
2013, District of Columbia

### Court Admissions

U.S. Patent and Trademark Office  
U.S. Supreme Court  
U.S. District Court for the Eastern  
District of North Carolina

### Practice Areas

Counseling, Opinions & Licensing  
Litigation  
Patent Prosecution

### Industries

Electrical & Computer Technologies  
Internet, E-Commerce & Business  
Methods  
Medical Devices



## BRADLEY C. WRIGHT

### Attorney

Brad Wright concentrates on prosecution, litigation and counseling in patent and copyright matters, especially in the electrical and computer areas, including Internet and e-commerce. He has drafted and prosecuted numerous patent applications in such technologies as computer hardware and software, cable TV systems, electrical devices, facsimile systems, neural networks, smart cards, Internet applications, operating systems, computer games, business methods, mobile telephones, and video processing techniques. In 2010, two patents drafted by Mr. Wright were successfully asserted in litigation, resulting in a \$200 million settlement.

Brad has also won several appeals before the Board of Patent Appeals and Interferences. He represents clients in district court litigation including patent, copyright and trademark matters. He has also successfully argued and briefed appeals before the U.S. Court of Appeals for the Federal Circuit. He has also provided clients with infringement, validity and patentability opinions in numerous different technical areas. Additionally, Brad is experienced with protecting inventions overseas under patent treaties and conventions.

Mr. Wright is a former law clerk to the Honorable William C. Bryson of the Court of Appeals for the Federal Circuit, which hears all patent appeals in the United States. He earned his electrical engineering degree from the Massachusetts Institute of Technology and his law degree, with *distinction*, from George Mason University, where he graduated as the top student in the Patent Law Track and was a member of the Law Review. After earning his electrical engineering degree, Brad worked as an electrical engineer and software engineering manager for E-Systems, which is now part of Raytheon Corp. In that position, Brad developed novel algorithms relating to signal intelligence and specialized hardware, and worked on database projects including an object-oriented database.

Mr. Wright is registered to practice before the U.S. Patent and Trademark Office. He is admitted to the bars of the Supreme Court, the Court of Appeals for the Federal Circuit, and is a member of the Virginia and District of Columbia bars. Brad is also active in the American Intellectual Property Law Association, where he co-chaired the Software Patent Subcommittee of the Emerging Technologies Committee. He is also a member of the Institute of Electrical and Electronic Engineers and the American Bar Association, where he chaired subcommittees relating to business method patents, patent litigation, and multimedia and interactive technology. Additionally, Brad has been an adjunct professor of law at George Mason University School of Law, where he has taught copyright and patent law.

Mr. Wright was the President of the Patent Lawyers Club of Washington. He has published numerous articles and has given speeches before various organizations regarding intellectual property law.

Mr. Wright served as Editor-in-Chief and a chapter author of *Drafting Patents for Litigation and Licensing*, published by BNA Books in 2008. This book, the first of its kind, was written to help patent practitioners draft the broadest possible patent that can sustain a validity challenge by synthesizing and applying lessons from the case law.

Mr. Wright has earned an AV Preeminent® peer review rating and was selected by Martindale-Hubbell as a 2013 Top Rated Lawyer in Appellate Law. Mr. Wright was selected to the Washington D.C. *Super Lawyers* list in 2014, and was named one of the World's Leading IP Strategists by *Intellectual Asset Management* magazine. He is listed as a leader in intellectual property law in the 2015 edition of *Best Lawyers in America*. He is recognized by *Managing Intellectual Property* as a 2014 IP Star.

Mr. Wright practices in the Washington, DC office of Banner & Witcoff, Ltd.

### Sample Articles and Publications

"Functional Claiming," presented at the *2014 9th Annual Advanced Patent Law Institute* (January 23-24, 2014)

"Developments in Patent Law 2013," presented at *The D.C. Bar's 2013 IP Law Year in Review Series* (December 11, 2013)

"Patent Developments for IT Practitioners," presented at the *2012 Virginia Information Technology Legal Institute* (September 28, 2012)

"Developments in Patent Law," presented at John Marshall Law School's *56th Anniversary Conference*



### Office

1100 13th Street, NW  
Suite 1200  
Washington, DC 20005-4051  
T 202.824.3000  
F 202.824.3001  
bwright@bannerwitcoff.com

### Education

B.S.E.E. 1984, Massachusetts  
Institute of Technology  
J.D. 1994, George Mason University

### Bar Admissions

1994, Virginia  
1995, District of Columbia

### Court Admissions

U.S. Circuit Court of Appeals for the  
Federal Circuit  
U.S. Court of Appeals for the Fourth  
Circuit  
U.S. Court of Appeals for the Sixth  
Circuit  
U.S. District Court for the District of  
Columbia  
U.S. District Court for the Eastern  
District of Virginia  
U.S. Patent and Trademark Office  
U.S. Supreme Court

### Practice Areas

Appellate Litigation  
Copyright  
Litigation  
Patent Prosecution

### Industries

Electrical & Computer Technologies  
Internet, E-Commerce & Business  
Methods

on *Developments in Intellectual Property Law* (February 24, 2012)

"Developments in Patent Law 2011," presented at *The D.C. Bar's 2011 IP Law Year in Review Series* (December 13, 2012)

"Patent Developments for IT Practitioners," presented at the *2011 Virginia Information Technology Legal Institute* (September 23, 2011)

"Drafting Patents for Litigation and Licensing, with 2011 Cumulative Supplement," *BNA and ABA-IPL* (August 1, 2011)

"Functional Claiming and Functional Disclosure," *Banner & Witcoff IP UPDATE* (Spring/Summer 2011)

"Developments in Patent Law 2010," presented at *The D.C. Bar's 2010 IP Law Year in Review Series* (December 15, 2010)

"Patent Developments for IT Practitioners", presented at the *2010 Virginia Information Technology Legal Institute* (October 8, 2010)

"Supreme Court Eases Test for Patentability in *Bilski v. Kappos*," *Intellectual Property Advisory* (June 28, 2010)

"Recent Developments in IP Law", presented at John Marshall Law School's *54th Annual Conference on Developments in Patent, Trademark, Copyright and Trade Secrets Law* (February 26, 2010)

"Developments in Patent Law 2009," presented at *The D.C. Bar's 2009 IP Law Year in Review Series* (December 18, 2009)

"Supreme Court Hears Argument in *Bilski* Case," *Intellectual Property Advisory* (November 9, 2009)

"Supreme Court Grants Cert in *Bilski* Case," *Banner & Witcoff IP UPDATE* (November 1, 2009)

"Federal Circuit Issues Split Decisions on PTO Continuation Rules," *Banner & Witcoff IP UPDATE* (Spring/Summer 2009)

"Developments in Patent Law," presented at *The D.C. Bar Program on Developments in Intellectual Property Law* (December 2008)

"End of the Road for E-Commerce Patents?," *E-Commerce Times* (May 2008)

"Patents Under Attack," *Executive Counsel* (June 2008)

"Federal Circuit May Clamp Down on Process Patents," *Intellectual Property Advisory* (May 8, 2008).

### **Recent Speaking Engagements**

"Patent Developments for IT Practitioners," 2012 Virginia Information Technology Legal Institute, Falls Church, VA, September 28, 2012.

"Recent Developments in Patent Law," John Marshall Law School's 56th Intellectual Property Law Conference, Chicago, IL, February 24, 2012.

"The Corporate Response to New Legislation: Changes in Portfolio Development and Patent Defense Strategies," 2012 Advanced Patent Law Institute at the USPTO, Alexandria, VA, January 19, 2012.

"The New Patent Law and More," DC Bar's IP Year in Review Series, Washington, DC, December 13, 2011.

"IP Basic Training Series: Patents, Trademarks, and Copyrights," D.C. Bar Conference Center, Washington, DC, October 18, 2011.

"Patent Developments for IT Practitioners," 2011 Virginia Information Technology Legal Institute, Falls Church, VA, September 23, 2011.

"Recent Developments in Patent Law," John Marshall Law School's 55th Intellectual Property Law Conference, Chicago, IL, February 25, 2011.

"Functional Claiming and Functional Disclosure," University of Texas at Austin, School of Law's 6th Annual Advanced Patent Law Institute, Alexandria, VA, January 21, 2011.

"Recent Developments in Patent Law," D.C. Bar's 2010 IP Year in Review Series, Washington, DC, December 15, 2010.

"Patent Developments for IT Practitioners," 2010 Virginia Information Technology Legal Institute, Falls Church, VA, October 8, 2010.



"Patentable Subject Matter After Bilski," BNA Webinar, July 8, 2010.

"The Use of Opinion of Counsel as Evidence in Patent Litigation," ABA IPL Section's 25th Annual Intellectual Property Law Conference, Arlington, VA, April 9, 2010.

"Recent Developments in IP Law," John Marshall Law School's 54th Annual Conference on Developments in Patent, Trademark, Copyright and Trade Secrets Law, Chicago, IL, February 26, 2010.

"Recent Developments in Patent Law," D.C. Bar's 2009 IP Year in Review Series, Washington, DC, December 17, 2009.

"Developments in Patent Law, 2008," D.C. Bar's 2008 IP Year in Review Series Part II, Washington, DC, December 10, 2008.

"New Practical Patent Strategies," Virginia Information Technology Center, Waterford, VA, September 26, 2008.



**CHICAGO, IL**  
Ten South Wacker Drive  
Suite 3000  
Chicago, IL 60606  
312.463.5000

**WASHINGTON, DC**  
1100 13th Street, NW  
Suite 1200  
Washington, DC 20005  
202.824.3000

**BOSTON, MA**  
28 State Street  
Suite 1800  
Boston, MA 02109  
617.720.9600

**PORTLAND, OR**  
One World Trade Center  
121 Southwest Salmon Street  
11th Floor  
Portland, OR 97204  
503.425.6800